



**IPC-A-600H CN**

**2010年4月**

**印制板的可接受性**

取代IPC-A-600G

2004年7月

本标准由IPC开发

*Association Connecting Electronics Industries*



## 标准化的原则

1995年5月，IPC技术行动执行委员会(TAEC)采用了该“标准化的原则”作为IPC致力标准化的指引原则。

### 标准应该

- 表达可制造性设计(DFM)与为环境设计(DFE)的关系
- 最小化上市时间
- 使用简单的(简化的)语言
- 只涉及技术规范
- 聚焦于最终产品的性能
- 提供有关应用和问题的反馈系统以利将来改进

### 标准不应该

- 抑制创新
- 增加上市时间
- 拒人于门外
- 增加周期时间
- 告诉你如何作某件事
- 包含任何禁不住推敲的数据

## 特别说明

IPC标准和出版物，通过消除制造商与客户之间的误解，推动产品的可交换性和产品的改进，协助买家进行选择并以最短的延迟时间获得满足其特殊需要的适当的产品，以实现为公众利益服务的宗旨。这些标准和出版物的存在，即不应当有任何考虑排斥IPC会员或非会员制造或销售不符合这些标准和出版物要求的产品，也不应当排斥那些IPC会员以外无论是国内还是国际的公众自愿采用。

IPC提供的标准和出版物是推荐性的，不考虑其采用是否涉及有关文献、材料或工艺的专利。IPC既不会对任何专利所有者承担任何义务，也不会对任何采用这些推荐性标准和出版物的团体承担任何义务。使用者对于一切专利侵权的指控承担全部辩护的责任。

## IPC关于规范修订变更的立场声明

使用和执行IPC的出版物完全出于自愿并且成为用户与供应商关系的一部分，这是IPC技术行动执行委员会的立场。当某个IPC出版物升级以及修订版面世时，TAEC的意见是，除非由合同要求，这种新的修订版作为现行版的一部分来使用的关系不是自动产生的。TAEC推荐使用最新版本。  
1998年10月6日起执行

## 为什么要付费购买本文件？

您购买本标准是在为今后的新标准开发和行业标准升级作贡献。标准让制造商、用户、供应商更好地相互理解。标准会帮助制造商建立满足行业规范的工艺，获得更高的效率，向用户提供更低的成本。

IPC每年投入数十万美元支持IPC的志愿者在标准和出版物上的开发。草案稿需要多遍审查，委员会的专家们要花费数百小时进行评审和开发。IPC员工要出席和参加委员会的活动，打印排版，以及完成所有必要的手续以达到ANSI(美国国家标准学会)认证要求。

IPC的会费一直保持在低位以使尽可能多的公司加入。因此，有必要用标准和出版物的收入补偿会费收入。IPC会员可以得到50%的折扣价格。如果贵公司需要购买IPC标准和出版物，为什么不加入会员得到这个实惠，并同时享有IPC会员的其他好处呢？有关IPC会员的其他信息，请浏览[www.ipc.org](http://www.ipc.org)，或致电001-847-597-2872。

感谢您的继续支持。

©2010版权归伊利诺斯州班诺克本市的IPC所有。依据《国际版权公约》及《泛美版权公约》保留所有权利。任何未经版权所有者的事先书面同意而对本资料进行的复印扫描或其它复制行为被严格禁止并构成《美国版权法》意义下的侵权。



IPC-A-600H CN

## 印制板的可接受性

If a conflict occurs between the English and translated versions of this document, the English version will take precedence.

本文件的英文版本与翻译版本如存在冲突，以英文版本为优先。

由IPC产品保证委员会（7-30）  
IPC-A-600任务组（7-31a）开发  
由IPC TGA Asia 7-31aCN技术组翻译

**取代：**  
IPC-A-600G – 2004年7月  
IPC-A-600F – 1999年11月

鼓励本标准的使用者参加未来修订版的开发。

联系方式：

IPC  
3000 Lakeside Drive, Suite 309S  
Bannockburn, Illinois  
60015-1249  
Tel 847 615.7100  
Fax 847 615.7105

IPC中国  
上海办公室  
电话：（8621）54973435/36  
深圳办公室  
电话：（86755）86141218/19  
北京办公室  
电话：（8610）67885326

此页留作空白



## 鸣谢

任何包含复杂技术的标准都要有大量的资料来源。IPC产品保证委员会（7-30）IPC-A-600任务组（7-31a）全体成员共同努力开发出了此项标准。谢谢他们为此做出的无私奉献。我们不可能罗列所有参与和支持本标准开发的个人和单位，下面仅仅列出了IPC-A-600任务组的主要成员。然而我们不得不提到IPC TGA Asia 7-31a CN技术组的成员，他们力求译文文字的信达雅，为此标准中文版的翻译、审核付出了艰苦的劳动。我们在此一并对上述各有关组织和个人表示衷心的感谢。特别感谢刚性印制板委员会（D-30）的成员为建立印制板验收标准所做的努力。

### 产品保证委员会

主席

Mel Parrish

STI Electronics

副主席

Michael E. Hill

Colonial Circuits, Inc.

### IPC-A-600任务组

主席

Mark Buechner

BAE Systems

副主席

Randy R. Reed

Viasystems Group, Inc.

### 刚性印制板委员会

主席

Vicka White

Honeywell Inc. Air Transport Systems

副主席

Debora Obitz

Trace Laboratories - East

### IPC董事会技术联络员

Peter Bigelow

IMI Inc.

Sammy Yi

Aptina Imaging Corp.

### IPC-A-600任务组

Lance Auer, Raytheon Missile Systems

Robert F. Bagsby, Rockwell Collins

Wendi Boger, DDi Corp.

Gerald Leslie Bogert, Bechtel Plant Machinery, Inc.

Scott Bowles, Hallmark Circuits Inc.

Elaine Brown, Lockheed Martin Systems Integration

Tracey Bumann, Minco Products Inc.

Byron Case, L-3 Communications

Laya Chen, Microtek (Changzhou) Product Services Co., Ltd.

Pei-Liang Chen, Shanghai Printronics Electronics Co., Ltd.

Christine Coapman, Delphi Electronics and Safety

C. Don Dupriest, Lockheed Martin Missiles and Fire Control

Theodore Edwards, Dynaco Corp.

Alan Exley, Raytheon Company

Gary Ferrari, FTG Circuits

Lionel Fullwood, WKK Distribution Ltd.

Mahendra Gandhi, Northrop Grumman Aerospace Systems

Thomas Gardeski, Gemini Sciences

Constantino Gonzalez, ACME Training & Consulting

Hue Green, Lockheed Martin Space Systems Company

Michael Green, Lockheed Martin Space Systems Company

Philip Henault, Raytheon Company

Michael Hill, Colonial Circuits Inc.

Eddie Huddleston, Elbit Systems of America

Todd Jarman, L-3 Communications

Candee Kaminski, Honeywell Inc. Air Transport Systems

Thomas E. Kemp, Rockwell Collins

Jason Koch, Robisan Laboratory Inc.

Nick Koop, Minco Products Inc.

Karin LaBerge, Microtek Laboratories

Leo Lambert, EPTAC Corporation

Jeff Lewis, Holaday Circuits Inc.

Michael G. Luke, Raytheon Company

Clifford Maddox, Boeing Company

Brian Madsen, Continental AG

Chris Mahanna, Robisan Laboratory Inc.

Rene Martinez, Northrop Grumman Aerospace Systems

Matthew McQueen, NSWC Crane

Renee J. Michalkiewicz, Trace Laboratories - East

Roger Miedico, Raytheon Company

Michael Miller, NSWC Crane

James Monarchio, TTM Technologies, Inc.

Bob Neves, Microtek Laboratories

Steven M. Nolan, Lockheed Martin Maritime Systems & Sensors

Debora Obitz, Trace Laboratories - East

William Orloff, Raytheon Company

Michael Paddack, Boeing Company

J. Lee Parker, JLP

Mel Parrish, STI Electronics

Marybeth Perrino, Endicott Interconnect Technologies Inc

Stephen Pierce, SGP Ventures, Inc.

Donna Richardson, M-Flex (Multi-Fineline Electronix Inc)

Jose Rios, Endicott Interconnect Technologies Inc

Gary Roper, Roper Resources, Inc.

Joseph Schmidt, Raytheon Missile Systems

Russell Shepherd, Microtek Laboratories

Lowell Sherman, Defense Supply Center Columbus

James Stack, Endicott Interconnect Technologies Inc

Kevin Therault, Lockheed Martin Space Systems Company

Dung Q. Tiet, Lockheed Martin Space Systems Company

Bradley Toone, L-3 Communications

Crystal E. Vanderpan, Underwriters Laboratories Inc.

Sharon Ventress, U.S. Army Aviation & Missile Command

Rob Walls, PIEK International Education Centre BV

Clark Webster, ALL Flex LLC

Vicka White, Honeywell Inc. Air Transport Systems

Dewey Whittaker, Honeywell Inc. Air Transport Systems

Mike Wilson, Minco Products Inc.

# Table of Contents (目录)

Acknowledgment (鸣谢)	iii	2.6 Holes – Unsupported (非支撑孔)	38
1 Introduction (前言)	1	2.6.1 Haloing (晕圈)	38
1.1 Scope (范围)	1	2.7 Printed Contacts (印制接触片)	39
1.2 Purpose (目的)	1	2.7.1 Surface Plating – Plated Contacts (表面镀层 – 电镀的接触片)	39
1.3 Approach To This Document (本文件的使用方法)	1	2.7.1.1 Surface Plating – Wire Bond Pads (表面镀层 – 金属线键合盘)	41
1.4 Classification (产品分级)	2	2.7.2 Burrs on Edge-Board Contacts (印制接触片 – 边缘毛刺)	43
1.5 Acceptance Criteria (验收准则)	2	2.7.3 Adhesion of Overplate (外镀层附着力)	44
1.6 Applicable Documents (引用文件)	4	2.8 Marking (标记)	45
1.6.1 IPC	4	2.8.1 Etched Marking (蚀刻标记)	48
1.6.2 American Society of Mechanical Engineers (美国机械工程师协会)	4	2.8.2 Screened or Ink Stamped Marking (丝印或油墨盖印标记)	50
1.7 Dimensions and Tolerances (尺寸与公差)	5	2.9 Solder Mask (阻焊膜 (阻焊剂))	52
1.8 Terms and Definitions (术语和定义)	5	2.9.1 Coverage Over Conductors (Skip Coverage) (导体上的覆盖 (跳印))	53
1.9 Revision Level Changes (版本修订变化)	5	2.9.2 Registration to Holes (All Finishes) (与孔的重合度 (所有涂覆层))	54
1.10 Workmanship (工艺质量)	5	2.9.3 Registration to Other Conductive Patterns (与其它导电图形的重合度)	55
2 Externally Observable Characteristics (外部可观察特性)	6	2.9.3.1 Ball Grid Array (Solder Mask-Defined Lands) (球栅阵列 (阻焊膜限定的焊盘))	56
2.1 Printed Board Edges (印制板边缘)	6	2.9.3.2 Ball Grid Array (Copper-Defined Lands) (球栅阵列 (铜箔限定的焊盘))	57
2.1.1 Burrs (毛刺)	6	2.9.3.3 Ball Grid Array (Solder Dam) (球栅阵列 (阻焊坝))	58
2.1.1.1 Nonmetallic Burrs (非金属毛刺)	7	2.9.4 Blisters/Delamination (起泡/分层)	59
2.1.1.2 Metallic Burrs (金属毛刺)	8	2.9.5 Adhesion (Flaking or Peeling) (附着力 (剥落或起皮))	61
2.1.2 Nicks (缺口)	9	2.9.6 Waves/Wrinkles/Ripples (波纹/褶皱/皱纹)	62
2.1.3 Haloing (晕圈)	10	2.9.7 Tenting (Via Holes) (掩蔽 (导通孔))	63
2.2 Base Material Surface (基材表面)	11	2.9.8 Soda Strawing (吸管状空隙)	64
2.2.1 Weave Exposure (露织物)	12	2.10 Pattern Definition – Dimensional (图形精确度 - 尺寸要求)	66
2.2.2 Weave Texture (显布纹)	13	2.10.1 Conductor Width and Spacing (导体宽度和间距)	66
2.2.3 Exposed/Disrupted Fibers (暴露/断裂的纤维)	14	2.10.1.1 Conductor Width (导体宽度)	67
2.2.4 Pits and Voids (麻点和空洞)	15	2.10.1.2 Conductor Spacing (导体间距)	68
2.3 Base Material Subsurface (基材表面下)	16	2.10.2 External Annular Ring – Measurement (外层环宽的测量)	69
2.3.1 Measling (白斑)	21	2.10.3 External Annular Ring – Supported Holes (支撑孔的外层环宽)	70
2.3.2 Crazeing (微裂纹)	22	2.10.4 External Annular Ring – Unsupported Holes (非支撑孔的外层环宽)	72
2.3.3 Delamination/Blister (分层/起泡)	24	2.11 Flatness (平整度)	73
2.3.4 Foreign Inclusions (外来夹杂物)	26	3 Internally Observable Characteristics (内部可观察特性)	75
2.4 Solder Coatings and Fused Tin Lead (焊料涂覆层和热熔锡铅层)	28	3.1 Dielectric Materials (介质材料)	76
2.4.1 Nonwetting (不润湿)	28	3.1.1 Laminate Voids/Cracks (Outside Thermal Zone) (层压板空洞/裂缝 (受热区外))	76
2.4.2 Dewetting (退润湿)	29	3.1.2 Registration/Conductor to Holes (导体与孔的重合度)	78
2.5 Holes – Plated-Through – General (镀覆孔 - 通孔)	31		
2.5.1 Nodules/Burrs (结瘤/毛刺)	31		
2.5.2 Pink Ring (粉红圈)	32		
2.5.3 Voids – Copper Plating (铜镀层空洞)	33		
2.5.4 Voids – Finished Coating (最终涂覆层空洞)	34		
2.5.5 Lifted Lands – (Visual) (焊盘起翘 - (目检))	35		
2.5.6 Cap Plating of Filled Holes – (Visual) (填塞孔的盖覆电镀 - (目检))	36		

# Table of Contents (目录)

3.1.3	Clearance Hole, Unsupported, to Power/Ground Planes (电源层/接地层上的非支撑孔, 隔离孔) .....	79	3.5.1	Roughness and Nodules (粗糙度和结瘤) .....	129
3.1.4	Delamination/Blister (分层/起泡) .....	80	3.5.2	Flare (锥口) .....	130
3.1.5	Etchback (凹蚀) .....	81	<b>4</b>	<b>Miscellaneous (其他类型板)</b> .....	<b>131</b>
3.1.5.1	Etchback (凹蚀) .....	82	<b>4.1</b>	<b>Flexible and Rigid-Flex Printed Boards (挠性及刚挠性印制板)</b> .....	<b>132</b>
3.1.5.2	Negative Etchback (负凹蚀) .....	84	4.1.1	Coverlay Coverage – Coverfilm Separations (覆盖层覆盖 – 覆盖膜分离) .....	133
3.1.6	Smear Removal (去钻污) .....	85	4.1.2	Coverlay/Covercoat Coverage – Adhesives (覆盖层/覆盖涂层的覆盖 – 粘接剂) .....	134
3.1.7	Dielectric Material, Clearance, Metal Plane for Supported Holes (金属层上支撑孔的介质间距) .....	87	4.1.2.1	Adhesive Squeeze-Out – Land Area (焊盘区域粘接剂的挤出) .....	134
3.1.8	Layer-to-Layer Spacing (层间间距) .....	88	4.1.2.2	Adhesive Squeeze-Out – Foil Surface (铜箔表面粘接剂的挤出) .....	135
3.1.9	Resin Recession (树脂凹缩) .....	89	4.1.3	Access Hole Registration for Coverlay and Stiffeners (元器件孔与覆盖层及增强板的重合度) .....	136
3.1.10	Hole Wall Dielectric/Plated Barrel Separation (Hole Wall Pullaway) (孔壁介质与孔壁镀层分离 (孔壁拉脱)) .....	90	4.1.4	Plating Defects (镀层缺陷) .....	137
<b>3.2</b>	<b>Conductive Patterns – General (导电图形 - 总则)</b> .....	<b>91</b>	4.1.5	Stiffener Bonding (增强板的粘接) .....	138
3.2.1	Etching Characteristics (蚀刻特性) .....	94	4.1.6	Transition Zone, Rigid Area to Flexible Area (刚性区域与挠性区域的过渡区) .....	140
3.2.2	Print and Etch (丝印及蚀刻) .....	96	4.1.7	Solder Wicking/Plating Penetration Under Coverlay (覆盖层下的焊料芯吸/镀层渗透) .....	141
3.2.3	Surface Conductor Thickness (Foil Plus Plating) (表面导体厚度 (铜箔加上镀层)) .....	97	4.1.8	Laminate Integrity (层压板完整性) .....	143
3.2.4	Foil Thickness – Internal Layers (内层铜箔厚度) .....	98	4.1.8.1	Laminate Integrity – Flexible Printed Board (层压板完整性 – 挠性印制板) .....	144
<b>3.3</b>	<b>Plated-Through Holes – General (镀覆孔 - 总则)</b> .....	<b>99</b>	4.1.8.2	Laminate Integrity – Rigid-Flex Printed Board (层压板的完整性 – 刚挠性印制板) .....	145
3.3.1	Annular Ring – Internal Layers (内层环宽) .....	101	4.1.9	Etchback (Type 3 and Type 4 Only) (凹蚀 (仅3型和4型板)) .....	146
3.3.2	Lifted Lands – (Cross-Sections) (焊盘起翘 (显微切片)) .....	103	4.1.10	Smear Removal (Type 3 and 4 Only) (去钻污 (仅3型和4型板)) .....	147
3.3.3	Foil Crack – (Internal Foil) “C”Crack (铜箔裂缝 – (内层铜箔) C型裂缝) .....	104	4.1.11	Trimmed Edges/Edge Delamination (裁切边缘/边缘分层) .....	148
3.3.4	Foil Crack (External Foil) (铜箔裂缝 (外层铜箔)) .....	105	4.1.12	Fold/Bend Marks (折叠/弯曲痕迹) .....	150
3.3.5	Plating Crack (Barrel) “E”Crack (镀层裂缝 (孔壁) – E型裂缝) .....	106	4.1.13	Silver Film Integrity (银膜完整性) .....	151
3.3.6	Plating Crack – (Corner) “F”Crack (镀层裂缝 – (拐角) F型裂缝) .....	107	<b>4.2</b>	<b>Metal Core Printed Boards (金属芯印制板)</b> .....	<b>153</b>
3.3.7	Plating Nodules (镀层结瘤) .....	108	4.2.1	Type Classifications (分类) .....	154
3.3.8	Copper Plating Thickness – Hole Wall (铜镀层厚度 – 孔壁) .....	109	4.2.2	Spacing Laminated Type (层压型板的间距) .....	155
3.3.9	Copper Wrap Plating (铜包覆电镀) .....	110	4.2.3	Insulation Thickness, Insulated Metal Substrate (绝缘型金属基板的绝缘厚度) .....	156
3.3.10	Plating Voids (镀层空洞) .....	113	4.2.4	Insulation Material Fill, Laminated Type Metal Core (层压型金属芯板的绝缘材料填充) .....	157
3.3.11	Solder Coating Thickness (Only When Specified) (焊料涂层厚度 (仅当有规定时)) .....	115	4.2.5	Cracks in Insulation Material Fill, Laminated Type (层压型板绝缘材料填充中的裂缝) .....	158
3.3.12	Solder Mask Thickness (阻焊膜厚度) .....	116	4.2.6	Core Bond to Plated-Through Hole Wall (金属芯与镀覆孔壁的连接) .....	159
3.3.13	Wicking (芯吸) .....	117	<b>4.3</b>	<b>Flush Printed Boards (齐平印制板)</b> .....	<b>160</b>
3.3.13.1	Wicking, Clearance Holes (隔离孔的芯吸) .....	118	4.3.1	Flushness of Surface Conductor (表面导体的平整性) .....	160
3.3.14	Innerlayer Separation – Vertical (Axial) Microsection (内层分离 – 垂直 (轴向) 显微切片) .....	119	<b>5</b>	<b>Cleanliness (清洁度测试)</b> .....	<b>161</b>
3.3.15	Innerlayer Separation – Horizontal (Transverse) Microsection (内层分离 – 水平 (横向) 显微切片) .....	120	<b>5.1</b>	<b>Solderability (可焊性测试)</b> .....	<b>162</b>
3.3.16	Material Fill of Blind and Buried Vias (埋/盲导通孔的材料填充) .....	121	5.1.1	Plated-Through Holes (Applicable to Test C/C1) (镀覆孔 (适用于C/C1 测试)) .....	163
3.3.17	Cap Plating of Filled Holes (填充孔的盖覆电镀) .....	123	<b>5.2</b>	<b>Electrical Integrity (电气完整性)</b> .....	<b>164</b>
<b>3.4</b>	<b>Plated-Through Holes – Drilled (镀覆孔 - 钻孔)</b> .....	<b>125</b>			
3.4.1	Burrs (毛刺) .....	126			
3.4.2	Nailheading (钉头) .....	127			
<b>3.5</b>	<b>Plated-Through Holes – Punched (镀覆孔 - 冲孔)</b> .....	<b>128</b>			

## Introduction (前言)

### 1.1 SCOPE

This document describes the preferred, acceptable, and nonconforming conditions that are either externally or internally observable on printed boards. It represents the visual interpretation of minimum requirements set forth in various printed board specifications, e.g.; IPC-6010 series, J-STD-003, etc.

#### 1.1 范围

本文件描述了可从印制板外部或内部观察到的理想的、可接受的和不符合的条件,给出了在各种印制板规范,即IPC-6010系列文件、J-STD-003等文件中描述的最低要求的图示说明。

### 1.2 PURPOSE

The visual illustrations in this document portray specific criteria of the requirements of current IPC specifications. In order to properly apply and use the content of this document, the printed board should comply with the design requirements of the applicable IPC-2220 series document and the performance requirements of the applicable IPC-6010 series document. In the event the printed board does not comply with these or equivalent requirements, then the acceptance criteria should be as agreed between user and supplier (AABUS).

#### 1.2 目的

本文件中的目检示意图描述了现有IPC规范要求的具体准则。为了适当地运用和使用本文件内容,印制板应该符合适用的IPC-2220系列文件的设计要求和适用的IPC-6010系列文件的性能要求。在印制线路板不符合这些要求或等效要求的情况下,验收准则应该由供需双方协商确定(AABUS)。

### 1.3 APPROACH TO THIS DOCUMENT

Characteristics are divided into two general groups:

- Externally Observable (section 2)
- Internally Observable (section 3)

“**Externally observable**” conditions are those features or imperfections which can be seen and evaluated on or from the exterior surface of the board. In some cases, such as voids or blisters, the actual condition is an internal phenomenon and is detectable from the exterior.

“**Internally observable**” conditions are those features or imperfections that require microsectioning of the specimen or other forms of conditioning for detection and evaluation. In some cases, these features may be visible from the exterior and require microsectioning in order to assess acceptability requirements.

Specimens should be illuminated during evaluation to the extent needed for effective examination. The illumination should be such that no shadow falls on the area of interest except those shadows caused by the specimen itself. It is recommended that polarization

and/or dark field illumination be employed to prevent glare during the examination of highly reflective materials.

The illustrations in this document portray specific criteria relating to the heading and subheading of each page, with brief descriptions of the acceptable and nonconforming conditions for each product class. (See 1.4.) The visual quality acceptance criteria are intended to provide proper tools for the evaluation of visual anomalies. The illustrations and photographs in each situation are related to specific requirements. The characteristics addressed are those that can be evaluated by visual observation and/or measurement of visually observable features.

Supported by appropriate user requirements, this document should provide effective visual criteria to quality assurance and manufacturing personnel.

This document cannot cover all of the reliability concerns encountered in the printed board industry; therefore, attributes not addressed in this issue **shall** be AABUS. The value of this document lies in its use as a baseline document that may be modified by expansions, exceptions, and variations which may be appropriate for specific applications.

When making accept and/or reject decisions, the awareness of documentation precedence must be maintained.

This document is a tool for observing how a product may deviate due to variation in processes. Refer to IPC-9191.

IPC-A-600 provides a useful tool for understanding and interpreting Automated Inspection Technology (AIT) results. AIT may be applicable to the evaluation of many of the dimensional characteristics illustrated in this document.

#### 1.3 本文件的使用方法

本文件中的有关特性可分为两大类:

- 外部可观察特性(第2章)
- 内部可观察特性(第3章)

“外部可观察特性”是指那些可在或可从板外表面观察到并进行评定的特征或瑕疵。在某些情况下,例如空洞或起泡,其实际状况是一种内部现象,但可从外部进行检查。

“内部可观察特性”是指那些需要对试样进行显微剖切片或采用其它方法处理才能检查和评定的特征或缺陷。在某些情况下,这些特征可从外部观察到,但仍需要进行显微剖切,以确定其是否符合可接受性要求。

为了有效地进行检查,在评定过程中应该保证试样有足够照明,即除试样本身引起的阴影外,照明不应该在所观察的区域产生阴影。建议采用偏振光和/或暗场照明,防止在检验强反射材料的过程中受反光的影响。

本文件中的示意图描述了与每页主标题和副标题有关的具体准则,并以文字简述了每级产品的可接受条件和不符合条件(见1.4节)。目检质量验收准则旨在为评定可见异常情况提供



## Introduction (cont.) (前言 (续))

适当的工具。每一种情况下的示意图和照片与具体的要求有关。本文件描述的各种特征可通过目视观察和/或对目视可观察特征的测量进行评定。

本文件再加上适当的用户要求，应该足以作为质量保证及制造人员提供有效的目检准则。

本文件不可能覆盖印制板行业遇到的所有可靠性问题，因此，凡本文件没有提到的特性应当由供需双方协商确定（AABUS）。本文件的价值在于可将其作为基础文件，为了使之适合于某些具体的应用，可以对其进行补充、免除和变更等修改。

当作出接受和/或拒收决定时，必须了解并遵守文件的优先顺序。

本文件可作为观察产品如何因工艺波动而导致其质量可能偏离的一种工具。参见IPC-9191。

IPC-A-600为理解和解释采用自动检测技术（AIT）检测出的结果提供了有效的工具。自动检测技术（AIT）可用于评定本文件图示的许多尺寸特性。

#### 1.4 CLASSIFICATION

This standard recognizes that electrical and electronic products are subject to classifications by intended end-item use. Three general end-product classes have been established to reflect differences in producibility, complexity, functional performance requirements, and verification (inspection/test) frequency. It should be recognized that there may be overlaps of product between classes.

Process Indicator imperfections are permitted and are deliverable.

The user is responsible for defining the product class. The procurement documentation package shall state the product class and any exceptions to specific parameters, where appropriate.

Criteria defined in this document reflect three classes, which are as follows:

**Class 1** – Includes limited life products suitable for applications where the requirement is function of the completed product.

**Class 2** – Includes products where continued performance and extended life is required, and for which uninterrupted service is desired but not critical.

**Class 3** – Includes products where continued high performance or performance-on-demand is critical, product downtime cannot be tolerated, and the product must function when required.

Acceptability criteria in this document have been separated so that printed board product may be evaluated to any one of the three classes. The use of one class for a specific characteristic does not mean that all other characteristics must meet the same class. Selection should be based on minimum need. The customer has the ultimate responsibility for identifying the class to which the product is evaluated. Thus, accept and/or reject decisions must be based on

applicable documentation such as contracts, procurement documentation, specifications, standards and reference documents.

#### 1.4 产品分级

本文件认可电气和电子产品的级别由其预期的最终用途决定。根据生产性、复杂性、功能性能要求及验证（检验/测试）频次将印制板分为三个通用级别。应该认识到不同级别的产品之间可能会重叠。

制程警示类瑕疵是允许的，可交付使用。

用户负责产品级别的界定。采购文件包应当描述其产品级别和对具体参数的任何例外（适用时）。

本文件中定义的准则反映了如下三个级别：

**1级** – 包括寿命有限、对整机产品仅有功能性要求的产品。

**2级** – 包括要求持续运行和较长寿命的产品，同时希望产品能够不间断地工作，但这一要求并不严格。

**3级** – 包括以连续高性能运行或严格按指令运行为关键的产品。这类产品的服务中断是不允许的，且在有要求时必须能够正常工作。

本文件的验收准则是按三种级别分别列出的，可按照三个级别中的任何一个级别来评定印制板产品。对某一具体特性使用某一级别的要求，并不意味着所有的其它特性也必须使用同一级别的要求。产品级别的选择应该基于最低需要。用户对确定产品的级别负有最终责任。因此，必须根据适用的文件，如合同、采购文件、规范、标准和引用文件来作出接受和/或拒收的决定。

#### 1.5 ACCEPTANCE CRITERIA

Most of the illustrations and photographs included in this document represent three levels of quality for each specific characteristic; i.e., Target Condition, Acceptable and Nonconforming. The text included with each level establishes the “Acceptance Criteria” for each class of product.

**Target Condition** in many cases is close to perfect. While this is the desired condition it is not always achievable and may not be necessary to ensure the reliability of the printed board in its service environment.

**Acceptable** indicates that the condition depicted, while not necessarily perfect, will maintain the integrity and reliability of the printed board in its service environment. The acceptable condition is considered acceptable for at least one or more classes but may not be acceptable for all classes, as specified by the associated acceptance criteria.

**Nonconforming** indicates that the condition depicted may be insufficient to ensure the reliability of the printed board in its service environment. The nonconforming condition is considered

## Introduction (cont.) (前言 (续))

unacceptable for at least one or more classes of product but may be acceptable for other classes as specified by the associated acceptance criteria.

The target, acceptable and nonconforming conditions depicted herein and the associated acceptance criteria are intended to represent typical industrial practices. Requirements of individual product designs may deviate from these criteria.

The examples shown in the photographs and/or illustrations are sometimes exaggerated to make the referenced imperfection more apparent. The relationship between the text and the examples is not always parallel; it would be difficult to find many cases so specific that they would always match the acceptance criteria. When photographs or illustrations contained in this standard are not consistent with discussion in the written text, the written text takes precedence and should be followed.

It should also be noted that some of the photographs used may have more than one type of condition on the same example. It is necessary that the users of this document pay particular attention to the subject of each section to avoid misinterpretation.

It should be understood that the first inference to nonconformance given implies that all other conditions of lesser magnitude are acceptable. Thus, a criteria which states a nonconformance condition as 50% of the surface is pitted, for example, implies that anything less than 50% of the surface being pitted is acceptable for that characteristic in that class. Obviously, nonconformance in Class 1 implies nonconformance in Class 2 and Class 3; and likewise, nonconformance for Class 2 implies nonconformance in Class 3.

An inspector **shall not** make the selection as to which class the part under inspection belongs. When making accept and/or nonconformance decisions, the awareness of precedence of documentation must be maintained.

In all cases, documentation should be available to the inspector defining to which class the part submitted for inspection belongs.

Procedures and requirements for conducting visual inspections related to this document **shall** be in accordance with the requirements of the applicable performance specification.

In the event of conflict, the following order of precedence **shall** apply:

1. Purchase Order (including exceptions to the master drawing, if any)
2. Procurement documentation reflecting the customers detailed requirements (such as master drawing)
3. Other documents to the extent specified by the customer
4. The end item performance specification such as the IPC-6010 series when invoked by the customer
5. This acceptability document. Printed boards should be of uniform quality and **shall** conform to the IPC-6010 series.

IPC-6010 series establishes the minimum acceptability requirements for printed boards. This document, IPC-A-600, is a companion

and complementary document, providing pictorial interpretation of these requirements. It is not intended to be used as a performance specification for printed board manufacture or procurement.

IPC-A-600 can be used as a support document for inspection. It does not specify frequency of in-process inspection or frequency of end product inspection. Nor is the allowable number of nonconforming process indicators or the number of allowable repair/rework of defects specified.

Visual examination for applicable attributes **shall** be conducted at 3 diopters (approx. 1.75X). If the acceptable condition of a suspected defect is not apparent, it should be verified at progressively higher magnifications (up to 40X) to confirm that it is a defect. Dimensional requirements such as spacing or conductor width measurements may require other magnifications and devices with reticles or scales in the instrument, which allow accurate measurements of the specified dimensions. Contract or specification may require other magnifications.

Plated-through holes (PTHs) **shall** be internally examined for foil and plating integrity at a magnification of 100X. Referee examinations **shall** be accomplished at a magnification of 200X.

Automated Inspection Technology (AIT) results may be applicable to the evaluation of many of the dimensional characteristics illustrated in this document.

### 1.5 验收准则

本文件中的多数示意图和照片同时表示每一具体特性的三个质量等级，即理想条件、可接受条件和不符合条件。而每个等级的验收准则，则分别用不同的文字加以说明。

**目标条件** 在多数情况下它接近完美的程度。虽然这是理想的条件，但并不是总是可以达到，而且也不是保证印制板在其使用环境中的可靠性所必需的条件。

**可接受条件** 所描述的状况虽然未必完美，但却能保证印制板在其使用环境中的完整性和可靠性。正如相关验收准则的规定，可接受条件被认为至少对于一个级别或多个级别是可接受的，但对于所有级别可能不是都可接受的。

**不符合条件** 所描述的状况可能不足以保证印制板在其使用环境中的可靠性。不符合条件被认为至少对于一个级别或多个级别是不可接受的，但对于其他级别，按照相关验收准则的规定，可能是可接受的。

此处描述的理想条件、可接受条件和不符合条件及相关验收准则只代表常规的行业惯例。对于个别的产品设计，其要求可能与这些准则不一致。

为了更清楚地图示所讨论的瑕疵特性，所用的照片和/或示意图，往往有些夸张。文字说明与示例之间并非总是对应的；

## Introduction (cont.) (前言 (续))

很难找到与验收准则总是相一致的很多案例；当本标准中的照片或示意图与文字说明不一致时，以文字描述为优先，并应该遵循文字说明的规定。

还应该注意本文件中某些照片可能同时用来表示同一示例的多种状况。因此，本文件的使用者要特别注意每节的主题，以避免产生误解。

对于给定的不符合条件，应该理解为凡缺陷程度低于不符合条件的所有其它条件都是可接受的。因此，例如某项准则规定不符合条件为表面50%出现麻点，这意味着在该级别的印制板中，只要产生麻点的表面小于50%，对该特性来说是可接受的。显然，对于1级板是不符合的状况，意味着对于2级板和3级板也均为不符合；同样，对于2级板是不符合的状况意味着对于3级板也是不符合的状况。

检验员**不应当**对所检验产品归属哪一级别作出选择。在作出接受和/或不符合决定时，必须有意识地遵守文件优先顺序。

在所有情况下，应当向检验员提供确定交付检验产品属于哪一级别的文件。

与该文件相关的目视检验程序和要求，**应当**与所适用性能规范的要求相一致。

如果发生冲突，**应当**采用下列优先顺序：

1. 采购文件（如有，包括针对布设总图的例外条件）；
2. 反映客户详细要求的采购文件（如布设总图）；
3. 客户指定的其它文件；
4. 客户要求引用的最终产品的性能规范，例如IPC-6010系列文件；
5. 本可接受性文件。印制板应该具有一致的质量，并**应当**符合IPC-6010系列文件的规定。

IPC-6010系列文件规定了印制板的最低可接受性要求。而本文件，即IPC-A-600，则是为上述要求提供图示解释的一种配套及补充文件，不推荐用作印制板生产或采购的性能规范。

IPC-A-600可作为检验支持性文件。它没有规定对在制品的检验频次和对最终产品的检验频次。同时，也没有规定所允许的不符合的制程警示的数量，也没有规定对缺陷的维修/返工所允许的次数。

对适用特性进行目视检查**应当**在3个屈光度（1.75倍的放大倍数）下进行。如果疑似缺陷的可接受条件不明显，则应该将放大倍数逐步调高（直至40倍）以确认其是否为缺陷。对于尺寸检验，例如间距或导体宽度的测量，可能要求采用其它放大倍数和使用有十字线或刻度线的仪器，以便能对规定的尺寸进行精确测量。合同或规范也可能对放大倍数有其它要求。

**应当**在100倍的放大倍数下对镀覆孔内部的铜箔和镀层完整性进行检查。**应当**在200倍的放大倍数下进行仲裁检查。

1. www.ipc.org

2. Current and revised IPC Test Methods are available on the IPC Web Site (www.ipc.org/html/testmethods.htm)

3. www.asme.org

自动检查技术(AIT)可用于评定本文件图示的许多尺寸特性。

**1.6 Applicable Documents** The following specifications of the revision in effect at the time of order form a part of this document to the extent specified herein. If a conflict of requirements exists between this specification and the listed applicable documents, this specification **shall** take precedence.

**1.6 引用文件** 下订单时，下列文件的有效版本构成了本规范在此限定范围内的组成部分。如本规范和所列引用文件发生冲突，**应当**以本规范为优先。

### 1.6.1 IPC<sup>1</sup>

**J-STD-003** 印制板可焊性测试

**IPC-T-50** 电子电路互连与封装术语及定义

**IPC-TM-650** Test Methods Manual<sup>2</sup>

2.1.1 Microsectioning

2.1.1.2 显微剖切-半自动或全自动技术的剖切设备（替代方法）

2.2.2 Optical Dimensional Verification

2.3.25 Detection and Measurement of Ionizable Surface Contaminants

2.4.1 附着力 - 胶带测试

2.4.22 Bow and Twist

2.4.28.1 Adhesion, Solder Resist (Mask), Tape Test Method

2.6.25 Conductive Anodic Filament (CAF) Resistance Test (Electrochemical Migration Testing)

**IPC-SM-840** Qualification and Performance of Permanent Solder Mask

**IPC-2220** Family of Design Documents

**IPC-4562** Metal Foil for Printed Wiring Applications

**IPC-4781** Qualification and Performance Specification of Permanent, Semi-Permanent and Temporary Legend and/or Marking Inks

**IPC-6010** IPC-6010印制板性能系列文件

**IPC-9191** General Requirements for Implementation of Statistical Process Control

**IPC-9691** User Guide for the IPC-TM-650, Method 2.6.25, Conductive Anodic Filament (CAF) Resistance Test (Electrochemical Migration Testing)

### 1.6.2 美国机械工程师协会<sup>3</sup>

**ASME B46.1** Surface Texture (Surface Roughness, Waviness and Lay)

## Introduction (cont.) (前言 (续))

**1.7 DIMENSIONS AND TOLERANCES**

All dimensions and tolerances specified herein are applicable only to the end product. Dimensions are expressed in hard SI (metric) units and parenthetical soft imperial [inch] units.

Reference information is shown in parentheses ( ).

**1.7 尺寸与公差**

本文件规定的所有尺寸和公差仅适用于最终产品。尺寸以标准的国际单位制（公制）表示，方括号内为对应的英制尺寸。

圆括号（）内给出了参考信息。

**1.8 TERMS AND DEFINITIONS**

Terms and definitions **shall** be in accordance with IPC-T-50 and as defined in 1.8.1.

**1.8 术语和定义**

术语和定义均**应当**符合IPC-T-50及1.8.1节的规定。

**1.8.1 Process Indicator** A detectable anomaly, other than a defect, that is reflective of material, equipment, personnel, process and/or workmanship variation.

**1.8.1 制程警示** 反映了材料、设备、人员、工艺和/或工艺质量发生变异的可探测到的异常，但不是缺陷。

**1.9 Revision Level Changes** Changes made to this revision of the IPC-A-600 are indicated throughout by gray-shading of the relevant subsection(s). Changes to a figure or table are indicated by gray-shading of the figure or table header.

**1.9 版本修订变化** 本IPC-A-600修订版即H版通过灰色阴影标示出了发生修订的相关章节，但只用灰色阴影标示发生修订的图或表的名称。

**1.10 WORKMANSHIP**

Printed boards fabricated to the requirements of this document **shall** be processed in such a manner as to be uniform in quality and to preclude the introduction of dirt, foreign matter, oil, fingerprints, flux residues, or other contaminants that may affect the life or serviceability of the product. Printed boards **shall** be free of defects in excess of those allowed by this document. Acceptance of imperfections not specifically covered by this document **shall** be AABUS.

**1.10 工艺质量**

按本文件的要求制造的印制板**应当**采用这样一种方式进行生产，即能获得均匀一致的质量，并能避免那些可能影响产品寿命或使用可靠性的灰尘、外来物、油污、指印、助焊剂残留物或其他污染物。印制板上**不应当**存在超过本文件允许的缺陷，至于本文件没有明确涉及的瑕疵的验收，**应当**由供需双方协商确定（AABUS）。



### Introduction (引言)

This section addresses those characteristics which are observable from the surface. This includes those characteristics that are external and internal in the printed board but visible from the surface as follows:

- **Surface Imperfections** such as burrs, nicks, scratches, gouges, cut fibers, weave exposure and voids.
- **Subsurface Imperfections** such as foreign inclusions, measling/crazing, delamination, pink ring and laminate voids.
- **Imperfections in Conductive Pattern** such as loss of adhesion, reduction of conductor width or thickness due to nicks, pinholes, scratches, surface plating or coating defects.
- **Hole Characteristics** such as diameter, misregistration, foreign material, plating or coating defects and scratches.
- **Marking Anomalies** including location, size, readability, and accuracy.
- **Solder Mask Surface Coating Imperfections** such as misregistration, blisters, bubbles, delamination, adhesion, physical damage and thickness.
- **Dimensional Characteristics** including printed board size and thickness, hole size and pattern accuracy, conductor width and spacing, registration and annular ring.

本章叙述了从表面可观察到的各种特性，包括下列印制电路板的外部特性，以及某些可以从表面观察到的内部特性。

- **表面瑕疵：**如毛刺、缺口、划痕、凹槽、断裂的纤维、露织物和空洞等。
- **表面下瑕疵：**如外来夹杂物、白斑/微裂纹、分层、粉红圈及层压板空洞。
- **导电图形瑕疵：**如附着力缺失，由于缺口、针孔、划痕、表面镀层或涂覆层缺陷等引起的导体宽度和厚度的减少。
- **孔特性：**如孔径、对位不准、外来夹杂物及镀层或涂覆层缺陷或划痕。
- **标记异常：**包括位置、大小、可读性及准确度。
- **阻焊膜表面涂覆层瑕疵：**如对位不准、起泡、气泡、分层、附着力、物理损伤及厚度。
- **尺寸特性：**包括印制板尺寸及厚度、孔径及图形精度、导体宽度及间距、重合度及环宽。

### 2.1 Printed Board Edges (印制板边缘)

Imperfections such as burrs, nicks or haloing along the edge of the printed board are acceptable provided they do not exceed the limits below.

沿着印制板边缘的诸如毛刺、缺口或晕圈等瑕疵，只要它们不超过下列要求，均是可接受的。

#### 2.1.1 Burrs (毛刺)

Burrs are characterized by small lumps or masses with an irregular shape, convex to a surface, and are a result of a machine process, such as drilling or gouging.

毛刺的定义为从表面伸出的不规则小块状或团状凸出物，它是机械加工的结果，如钻孔或铣切工艺。

### 2.1.1.1 Nonmetallic Burrs (非金属毛刺)



图2111a

**Target Condition - Class 1,2,3 (目标条件 - 1,2,3级)**

- Edge conditions - smooth, no burrs.
- 边缘条件 - 光滑，无毛刺。



图2111b

**Acceptable - Class 1,2,3 (可接受条件 - 1,2,3级)**

- Edge conditions - rough but not frayed.
- Edge conditions - loose burrs do not affect fit and function.
- 边缘状况 - 粗糙但未磨损。
- 边缘状况 - 有疏松毛刺，但不影响安装和功能。



图2111c

**Nonconforming - Class 1,2,3 (不符合条件 - 1,2,3级)**

- Defects either do not meet or exceed above criteria.
- 缺陷不符合或超出上述要求。

## 2.1 BOARD EDGES (板边缘)

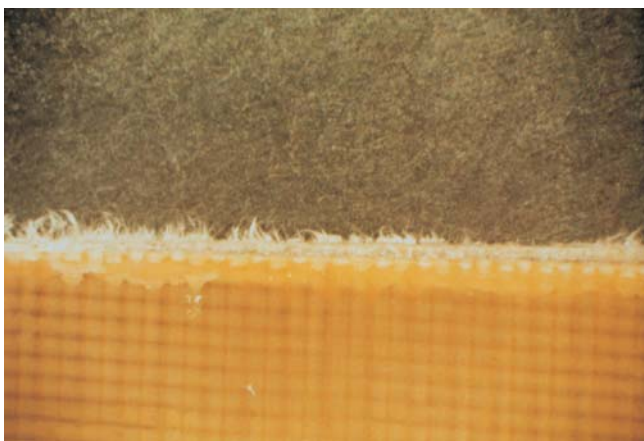
### 2.1.1.2 Metallic Burrs (金属毛刺)



图2112a

**Target Condition/Acceptable - Class 1,2,3**  
(目标条件/可接受条件 - 1,2,3级)

- Edges **shall** be clean cut and without metallic burrs.
- 边缘应当切割整齐，无金属毛刺。

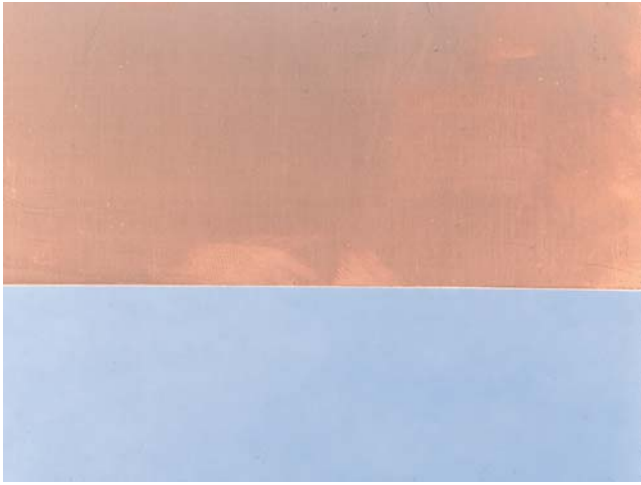

图2112b

**Nonconforming - Class 1,2,3** (不符合条件 - 1,2,3级)

- Defects either do not meet or exceed above criteria.
- 缺陷不符合或超出上述要求。

## 2.1 BOARD EDGES (板边缘)

### 2.1.2 Nicks (缺口)



图212a

#### Target Condition - Class 1,2,3 (目标条件 - 1,2,3级)

- Edge condition - smooth, no nicks.
- 边缘状况 - 光滑，无缺口。

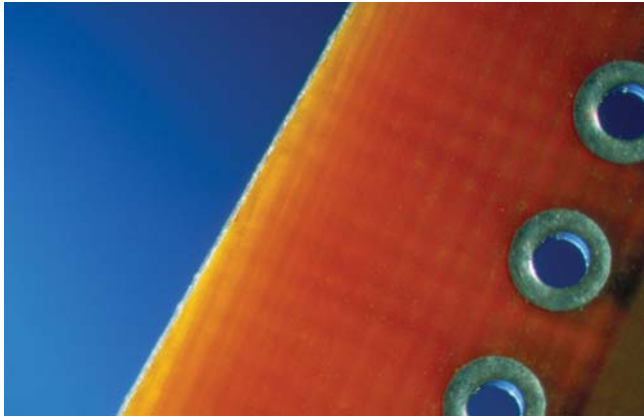

图212b

#### Acceptable - Class 1,2,3 (可接受条件 - 1,2,3级)

- Edges are rough but not frayed.
- Nicks do not exceed 50% of the distance from the printed board edge to the nearest conductor or 2.5 mm [0.0984 in], whichever is less.
- 边缘粗糙，但未磨损。
- 缺口深度不大于板边缘与最近导体间距的50%或不大于2.5mm[0.0984in]，取两者中的较小值。

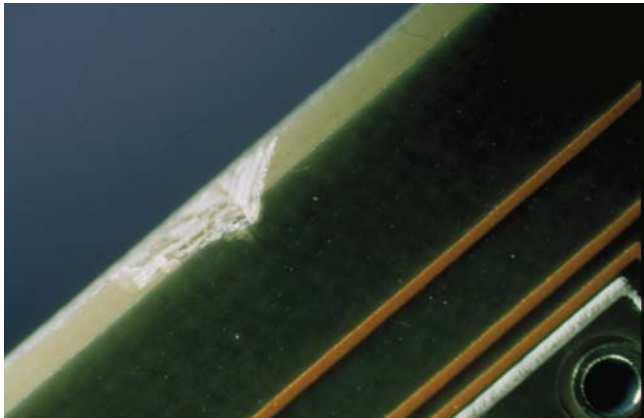

图212c

#### Nonconforming - Class 1,2,3 (不符合条件 - 1,2,3级)

- Defects either do not meet or exceed above criteria.
- 缺陷不符合或超出上述要求。

### 2.1.3 Haloing (晕圈)

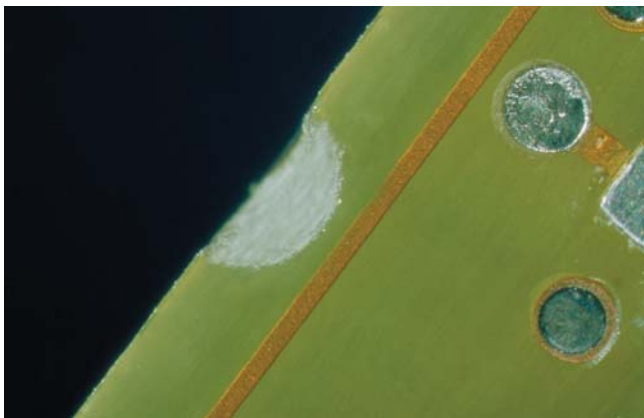

图213a



图213b

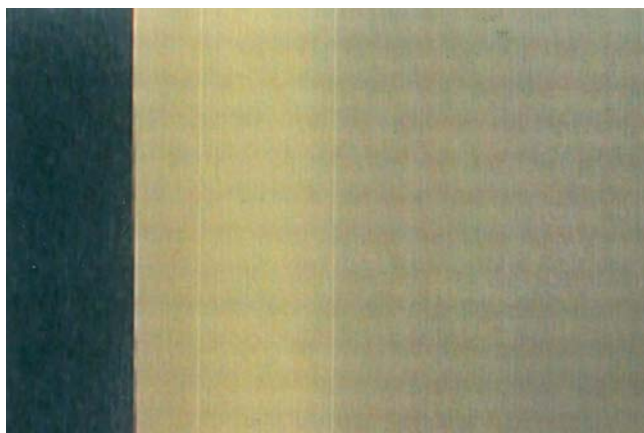

图213c

#### Target Condition - Class 1,2,3 (目标条件 - 1,2,3级)

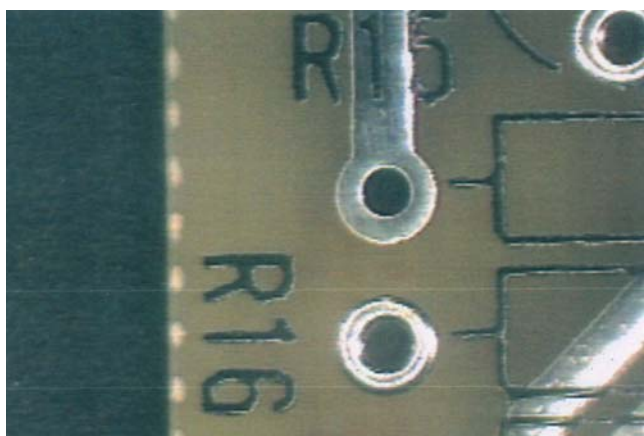
- No haloing.
- 无晕圈。

#### Acceptable - Class 1,2,3 (可接受条件 - 1,2,3级)

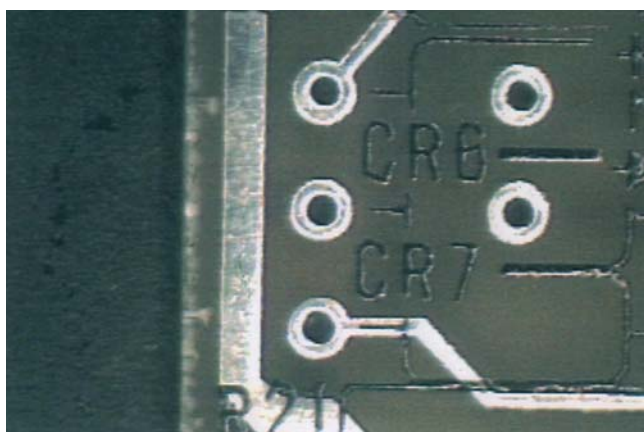
- Distance between the haloing penetration and the nearest conductive feature is not less than the minimum lateral conductor spacing, or 100  $\mu\text{m}$  [3,937  $\mu\text{in}$ ] if not specified.
- 晕圈的范围使从板边缘与最近导电图形间未受影响的距离不小于最小侧向导体间距，或不小于100 $\mu\text{m}$ [3,937 $\mu\text{in}$ ]，取两者中的较小值。

#### Nonconforming - Class 1,2,3 (不符合条件 - 1,2,3级)

- Defects either do not meet or exceed above criteria.
- 缺陷不符合或超出上述要求。



# Introduction (引言)

### Identification of Imperfections

Nondestructive visual criteria have been established to aid in the identification and disposition of laminate defects. Refer to the following sections where definitions, illustrations and photographs have been provided which precisely define and identify the following conditions:

#### Surface 2.2

- weave exposure 2.2.1
- weave texture 2.2.2
- exposed/disrupted fibers 2.2.3
- pits and voids 2.2.4

#### Subsurface 2.3

- measling 2.3.1
- crazing 2.3.2
- delamination/blister 2.3.3
- foreign inclusions 2.3.4

It is important to note that laminate defect conditions may exist when the fabricator receives the material from the laminator, or may become apparent during the fabrication of the printed board. Some defects may be induced during processing.

### 瑕疵的鉴别

为了帮助鉴别和处置层压板缺陷，业界已建立了无损目视检查准则，详见以下章节。这些章节给出了下列各种状况的定义、示意图和照片，精确地定义并区分了下列状况：

#### 基材表面 2.2

- 露织物 2.2.1
- 显布纹 2.2.2
- 暴露/断裂的纤维 2.2.3
- 麻点和空洞 2.2.4

#### 基材表面下 2.3

- 白斑 2.3.1
- 微裂纹 2.3.2
- 分层/起泡 2.3.3
- 外来夹杂物 2.3.4

重要的是，我们要注意层压板缺陷可能是在印制板生产商从层压板商处接收板材时就已经存在，或在印制板制造期间才显露出来。有些缺陷则可能是在加工过程中产生的。

## 2.2.1 Weave Exposure (露织物)

**Weave Exposure:** A surface condition of base material in which the unbroken fibers of woven cloth are not completely covered by resin.

**露织物:** 指基材的一种表面状况，即未断裂的织物纤维没有完全被树脂覆盖。



图221a

注：此图仅用作说明状况，并不要求做显微剖切评价。

### Acceptable - Class 3 (可接受条件 - 3级)

- No weave exposure.
- 没有露织物。

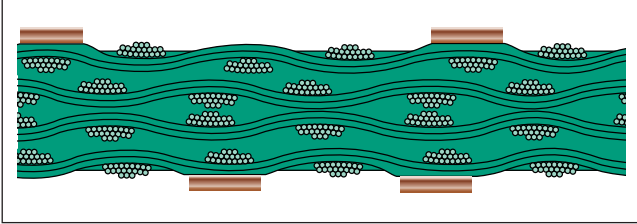
### Acceptable - Class 1,2 (可接受条件 - 1,2级)

- Excluding the area(s) with weave exposure, the remaining space between conductors meets the minimum conductor spacing requirement.
- 导体间除去露织物区域之外，余下的距离满足最小导体间距要求。



图221b

### Nonconforming - Class 1,2,3 (不符合条件 - 1,2,3级)

- Defects either do not meet or exceed above criteria.
- 缺陷不符合或超出上述要求。

## 2.2 BASE MATERIAL SURFACE (基材表面)

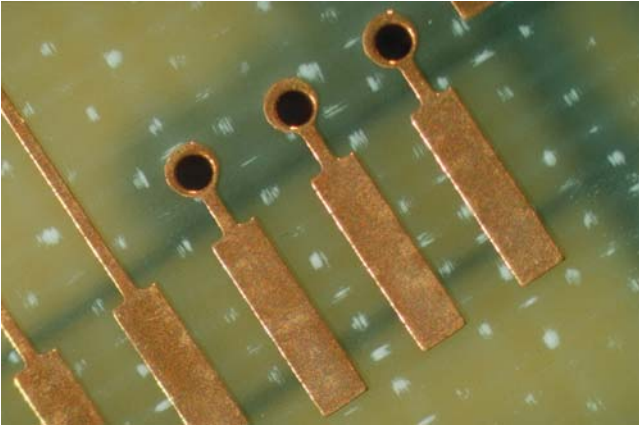
### 2.2.2 Weave Texture (显布纹)

**Weave Texture:** A surface condition of base material in which a weave pattern of cloth is apparent although the unbroken fibers of woven cloth are completely covered with resin.

**显布纹:** 指基材的一种表面状况，即尚未断裂的织物纤维虽被树脂完全覆盖，但编织纹路明显。



图222a

注：此图仅用作说明状况，并不要求做显微剖切评价。

#### Acceptable - Class 1,2,3 (可接受条件 - 1,2,3级)

- Weave texture is an acceptable condition in all classes but is sometimes confused with weave exposure because of similar appearances.
- 显布纹对于所有级别产品均是可接受的，但有时会因外观相似而与露织物相混淆。

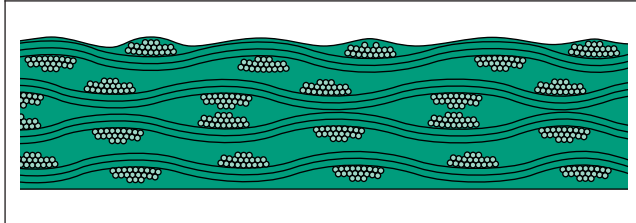

图222b

Figure 222b is an example of a surface condition that could be either weave exposure or weave texture. The difference cannot be determined from this view. The difference can be discerned using nondestructive tests (oblique illumination with microscope) or micro-section.

图222b的案例既可能是露织物，也可能是显布纹。通过该视图无法区分其差别。可采用非破坏性测试（倾斜照明下显微镜观察）或显微剖切确定。

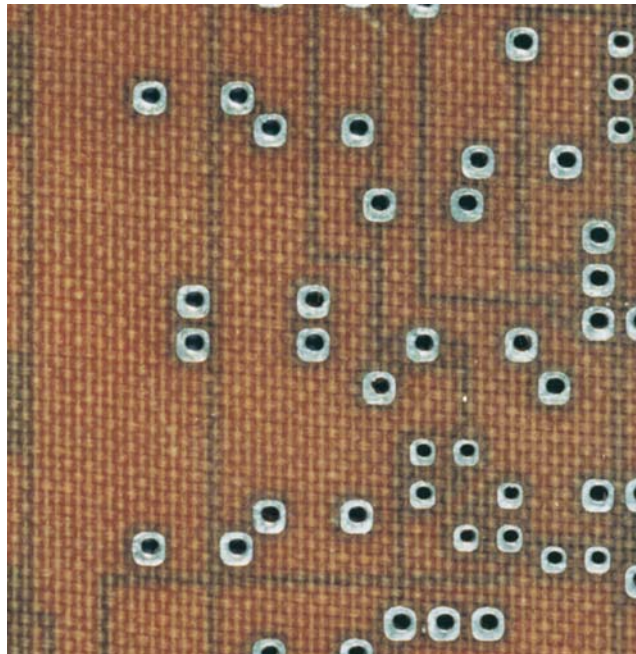

### 2.2.3 Exposed/Disrupted Fibers (暴露/断裂的纤维)



图223a

**Acceptable - Class 1,2,3 (可接受条件 - 1,2,3级)**

- Exposed or disrupted fibers do not bridge conductors and do not reduce the conductor spacing below the minimum requirements.
- 暴露或断裂的纤维未跨接导体，且未使导体的间距减少至低于最小要求。



图223b

**Nonconforming - Class 1,2,3 (不符合条件 - 1,2,3级)**

- Defects either do not meet or exceed above criteria.
- 缺陷不符合或超出上述要求。

## 2.2.4 Pits and Voids (麻点和空洞)

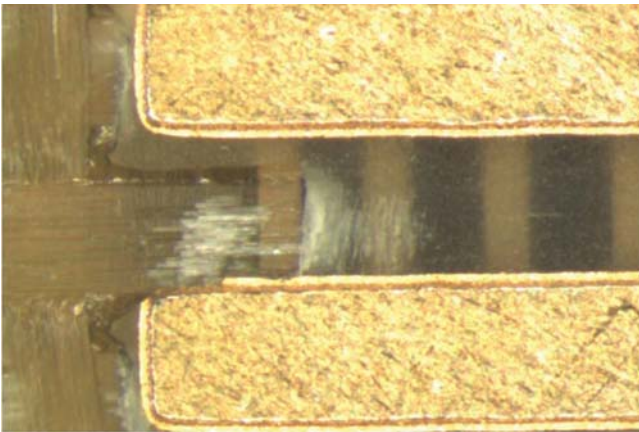

图224a

### Target Condition - Class 1,2,3 (目标条件 - 1,2,3级)

- No pits or voids.
- 无麻点和空洞。



图224b

### Acceptable - Class 1,2,3 (可接受条件 - 1,2,3级)

- Pits or voids do not exceed 0.8 mm [0.031 in].
- Total printed board area affected is less than 5% per either side.
- Pits or voids do not bridge conductors.
- 麻点或空洞不大于0.8mm[0.031in]。
- 印制板每面受影响的区域小于每面面积的5%。
- 麻点或空洞未跨接导体。

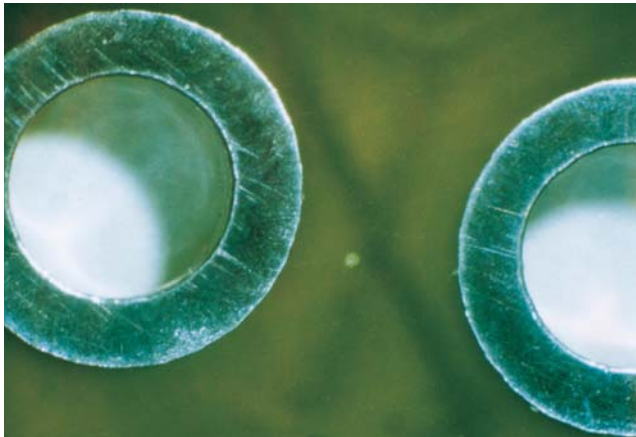

图224c

### Nonconforming - Class 1,2,3 (不符合条件 - 1,2,3级)

- Defects either do not meet or exceed above criteria.
- 缺陷不符合或超出上述要求。

## Introduction (引言)

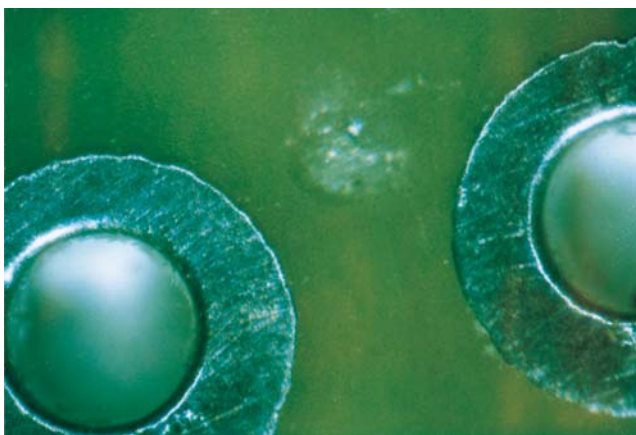
This section is focused on those subsurface conditions of laminated base materials that are externally observable through the base material itself and some solder mask coatings. The most frequent subsurface base material conditions are termed measling, crazing, delamination, blistering and foreign materials. These conditions may be observed throughout the printed board manufacturing and inspection process; such as:

- During incoming metal-clad base material evaluations after being manufactured by the laminator,
- By the printed board manufacturer after having removed (etched) the metal cladding in the preparation of “innerlayer” details for multilayer printed boards,
- After etching the “outer” layers of printed board to form the required arrangement of conductive patterns and markings,
- After baking operations (such as solder mask or component legends),
- After thermal shock, as in solder fusing/coating or solderability testing processes.

Base material subsurface conditions have been the subject of considerable discussion within the printed board industry for several decades. Of the several subsurface conditions, measling and crazing continue to cause the most concerns. Measles and crazing have been the primary focus of three IPC “Blue Ribbon Committees” of experts. The following are brief summaries and additional comments from the IPC Blue Ribbon Committees:

本节重点介绍透过基材本身和某些阻焊膜涂覆层从外表可观察到的层压基材表面下的状况。最常见的基材表面下状况有：白斑、微裂纹、分层、起泡和外来夹杂物。这些状况可在印制板整个生产过程和检验过程中发现，例如：

- 在来料检验基板生产商制造的覆金属箔基材时；
- 在印制板生产商蚀刻金属箔后为多层印制板制备“内层”图形的过程中；
- 为了形成所需导电图形和标记，蚀刻印制板“外”层之后；
- 烘干操作（例如阻焊剂或元器件字符）之后；
- 热冲击之后，例如焊料热熔/涂覆或可焊性测试过程中。

几十年来，基材的表面下状况已成为印制板行业内不容忽视的论题。在这些表面下状况中，白斑和微裂纹一直最受关注。白斑和微裂纹已成为三届IPC“蓝带委员会”专家所关注的焦点。下面是IPC蓝带委员会的概述和补充说明：

### Brief summary of the First IPC Blue Ribbon Committee on Measles

This first committee conducted a wide overview of printed board base material surface and subsurface conditions with a major focus on measles. IPC's “Measles in Printed Wiring Boards, Information Document” was published in 1973 as a result of this effort. The committee was to collect as much data as was available on measles

and other surface/subsurface conditions; and to standardize the terms, definitions (descriptions), photographs, and illustrations of surface and subsurface conditions. It was felt that sufficient research had been done by industry and that a position on “measles” could be prepared by the committee. The committee's recommendation was as follows, “comprehensive review of available literature and available research and test data, that while measles may be objectionable cosmetically, their effect on functional characteristics of finished products, are at worst minimal, and in most cases insignificant.”

Comments: Despite the committee's recommendation and industry data, there was still a strong reluctance by most government and industry personnel to accept that measles are a cosmetic condition with no functional effect in most applications. Most companies continued to retain “no measling” requirements in their specifications. But when measles or other nonconforming surface/subsurface conditions had severe impact on their production schedules, the customer (or acceptance agency) would produce a document that established acceptance guidelines for measles (and frequently other surface and subsurface conditions). The new guidelines were based on size, percent reduction in conductor spacing, and amount of affected area. They also varied from customer-to-customer. As technology evolved, in particular reductions in conductor spacing, the effect of measling and other surface/subsurface conditions once again became a serious industry wide concern. As a result, a second IPC Blue Ribbon Committee on Measles was formed.

### 第一届IPC蓝带委员会关于白斑的概述

首届委员会对印制板基材表面和表面下的状况，主要是白斑方面，进行了广泛的探讨。IPC于1973年发布了作为该项研究的成果——《印制电路板中的白斑，报告文献》。该委员会旨在尽可能多地搜集现有的关于白斑以及其他表面/表面下状况的资料，并标准化其术语、定义（说明）、照片以及图例。委员会认为业界已做了充分的研究，委员会可以为“白斑”作结论了。委员会的建议如下：“根据对现有文献和研究及测试数据的综合考察表明，从外观上讲，白斑可能是不美观的，但即使是最严重的白斑，对成品的功能特性的影响也是极微小的，且大多数情况下是无足轻重的”。

说明：尽管有委员会的建议和业界的研究数据，仍有多数政府及业界人士强烈抵制，他们拒不接受白斑只是一种外观上的状况，在大多数应用中无功能性影响的观点。多数公司的规范中仍保留“没有白斑”的要求。但是当白斑或其他不符合的表面/表面下状况严重影响其生产进度时，用户（或验收部门）就会行文制订白斑（通常包括其他表面和表面下状况）的验收导则。新的验收导则以导体间距减小的尺寸、减小的百分比，以及受影响面积为基础，具体要求因用户不同而异。随着技术的发展，尤其是导体间距的减小，白斑及其他表面/表面下状况的影响再一次成为业界关注的焦点。因此，关于白斑的第二届IPC蓝带委员会应运而生。

## Introduction (cont.) (引言 (续))

**Brief summary of the Second IPC Blue Ribbon Committee on Measles**

This second committee was formed in late 1978. This committee reviewed the findings of the first committee, solicited the industry for additional data, and reviewed the proprietary acceptance criteria provided by IPC members. The Second Blue Ribbon Committee came to the same conclusion. Measles are a cosmetic process indicator and had almost no reported effects on a product's functional performance in most applications. The major exception was high voltage applications. There was still reluctance by some government organizations and a few industrial companies to categorically accept measles. As such, this committee established a set of measling/crazing requirements that obtained consensus from all IPC members. The result was a matrix of acceptance limitations for the three major phases of the printed board electronic assembly process: laminated material, printed board final inspection, and after printed board assembly. These requirements included percent reductions in conductor spacing (not exceeding minimum conductor spacing), and various amounts of measled area for each side of the printed board (or assembly) based on the Class of product. These requirements were added as an amendment to the first printing of the IPC-A-600, Revision C, and were included in later printings of the C revision and, in a different format, the IPC-A-600, Revision D.

Comments: The primary concerns expressed by the reluctant individuals are summarized in the following list (with comments):

- Electrical Insulation Resistance, both volume and surface - several reports and available test data indicates that insulation resistance is not significantly affected by measling or crazing.
- Contamination - the concern was that ionic materials could diffuse or be "pumped" (by alternating atmospheric pressure) into measles or crazing and would result in lower insulation resistance or conductive anodic filament (CAF) growths, shorts. Salt spray tests indicated this was not a valid premise, and most ionic materials (such as salts) will not diffuse into the base material.
- Applied Voltages - high voltage applications are a concern (in particular where there is the possibility of "corona" in the measling or crazing) the dielectric strength is reduced by 20-50% in comparison to a similar non-measled/crazed area, in particular at altitudes greater than 20 km [12.43 miles].
- Environmental - most measling/crazing did not appear to increase in size or occurrence due to environmental testing.

IPC-A-600, Revision E, was the first revision to reflect the needs for surface mounted component technology. As such, the acceptance requirements for measling and crazing were separated. For measles, the acceptance requirements allowed bridging under sur-

face conductor spacing. This was done based on the definition of measles, test data, and industry experience of measles having never been documented to cause a functional failure. Crazing is much less controlled separation in the base material forming "interconnections" between measles and possibly adjacent conductive patterns; therefore, the acceptance requirements for crazing were set the same as the similar conditions of delamination and blistering.

Over a period of time, governing specifications have become excessively heavy regarding the presence of measles. In addition, cosmetic appearance has become a major acceptance criterion. In actual fact, no failure has ever been attributed to measling, based on all military and industry testing to date. IPC, industry and various military agencies have conducted extensive testing in severely measled assemblies under extreme environmental conditions for long periods of time with no evidence of growth, spreading or any detriment to the function of the assembly. Measles should not be the cause for rejection.

Measling is an internal condition occurring in the woven fiber reinforced laminated base material in which the bundles are separated at the weave intersection. The term "crazing" is sometimes used to describe an array of measles which appear from the surface to be interconnected. When the measles look to be interconnected, this condition called "crazing" is a form of delamination in that there are separations along the length of the fiber/yarns and the resin. For non-woven material, this condition resembles a measle but is randomly located and has an irregular shape (see Figure 23a).

In a case study done, the prime cause of the observed measles was a combination of moisture, which diffuses readily into epoxy-glass, and component soldering temperatures. The application of local high temperatures for component mounting caused entrapped moisture to vaporize and break the epoxy-glass bond at the "knuckle" (intersection of the warp and fill of the e-glass cloth). From previous experience, it is known that epoxy-glass absorbs atmospheric moisture, and when moisture content exceeds 0.3 wt%, it can give rise to measling during solder dip/level and/or assembly soldering operations.

There are other factors that can contribute to measles/crazing such as: resin composition, method of making laminates, coupling agents,  $T_g$ , etc. In the past, reports were compiled which revealed that measles and crazing with over 50% spacing violation were not adverse to the reliability of the hardware. Why, if all test reports showed no problems with measles and no reported field failures, are we so concerned about measles and crazing? Because it appears feasible, in theory, that if measles with 100% conductor spacing violation combines with moisture or some other contaminant, copper migration (IR failures) should be experienced between conductors.



## Introduction (cont.) (引言 (续))

Even when the potential failure mechanism mentioned above is analyzed, it is almost impossible to experience such (IR/ migration) failure. First, a measles(s) gapping conductive patterns is needed. Secondly, moisture in the printed board/ assembly, along with a conductive or ionic contaminant such as chlorides, is necessary.

In this instance, a typical industry example, the measles is at the center between two plated through holes (see Figure 23b). The measles is 0.4 mm [0.0157 in] wide. In order to get possible copper migration, the measles had to gap the two plated through holes. This of course would be most unlikely. The second example (see Figure 23c) illustrates what is required for a potential failure mechanism between two surface conductors. A (+) conductor directly over a knuckle is required and a (-) conductor is also required directly over a knuckle. For an electrical short to occur between these conductors through the base material, there would need to be a conductive path from one conductive pattern, through the remaining dielectric materials (resin and yarn) to the separation (measle), along the separation in the direction of the other conductive pattern, once again through the remaining dielectric materials (resin and yarn), and to the second conductive pattern. In order to induce a failure all of the above mentioned ingredients are required along with a voltage potential between two adjacent conductors. This occurrence is highly unlikely and is most likely why the industry has not experienced any adverse reliability problems due to measles.

When making acceptance calls on electronic hardware, consider all the possible concerns mentioned above. Measles should not be considered a nonconforming condition. It should instead be considered a process indicator, telling you that the process is on the verge of going out of control. Correct the problem, but do not scrap the product, taking into account all of the above mentioned variables.

### 第二届IPC蓝带委员会关于白斑的概述

第二届委员会成立于1978年底。它复审了第一届委员会的发现，向业界征询了更多的数据资料，并审阅了IPC会员提供的专有验收准则。第二届蓝带委员会得出了同样的结论。白斑是一种外观性的制程警示，在大多数应用中，几乎没有任何有关影响产品性能的报道。一个主要的例外是高压电应用。此时仍有一些政府机构和业界公司反对无条件地接受白斑。因此，该委员会制定了一套由所有IPC会员一致同意的白斑/微裂纹要求。形成的验收要求适用于印制板电子组装过程中三个主要阶段：层压板材料、印制板终检和印制板组装后。这些要求包括导体间距减小的百分比（不超出最小的导体间距）和基于产品级别的印制板（或组装件）每面的白斑区域的大小。这些要求作为修订本补充到IPC-A-600C版的首印版

中，并纳入IPC-A-600C的再版中，且在IPC-A-600D版中以不同形式出现。

说明：反对方阐明的主要顾虑归纳如下：

- 电气绝缘电阻，包括体积电阻和表面电阻 - 一些报告和现有的测试数据都表明：绝缘电阻受白斑或微裂纹的影响不明显。
- 污染 - 离子残留物可能会扩散或被“抽吸”（由于大气压发生变化）到白斑或微裂纹中，并会导致绝缘电阻的降低或导电阳极丝（CAF）的生长进而短路。盐雾测试表明，这个根据不能成立，大多数离子物（例如盐）不会扩散到基材中。
- 所用电压 - 高压应用关系是一个顾虑（尤其是白斑或微裂纹中可能出现“电晕”的情况下），与类似的无白斑/微裂纹区域相比，有白斑/微裂纹的区域的绝缘强度降低了20%~50%，尤其在20km（12.43英里）以上的海拔高度下。
- 环境 - 大多数白斑/微裂纹不会因环境测试而增加或尺寸扩大。

IPC-A-600E版本是第一个反映表面贴装元器件技术需求的修订版。因此，对白斑和微裂纹的验收要求便分开了。就白斑而言，验收要求允许其跨接表面导体间距。这样规定基于白斑的定义、测试数据，而且业界的经验中从来没有白斑导致功能性失效的记载。微裂纹是产生于基材内的一种更不受控的分离现象，形成白斑间的互连，其范围可能跨接相邻的导电图形，因此，对白斑的验收要求与类似的分层和起泡状况相同。

相当长一段时期，一些指导规范过于看重白斑现象。再者，外观也成为主要的验收准则。事实上，迄今为止，根据所有军方及工业界当前测试发现，白斑从未导致过任何失效。IPC、业界及各军方机构在极端环境条件下，对出现严重白斑的组件进行了广泛的测试，并没有发现白斑有增长、扩散或有损于组件功能的现象。白斑不应该作为拒收的理由。

白斑是发生在编织纤维增强型层压基板内的一种内在现象，基材内的纤维纱束在交叉处的粘合发生分离。“微裂纹”一词有时用来描述表面上连成片的白斑阵列现象。这种称作微裂纹的互连的白斑，其实是分层的一种形式，即纤维纱线沿其长度方向与树脂发生了分离。对于非编织的材料，这种情况类似于白斑但是随意排列且形状不规则（见图23a）。

在一项研究案例中，所观察到的白斑现象主要成因是能快速扩散到环氧玻璃中的湿气和元器件焊接时的温度共同作用的结果。元器件贴装时产生的局部高温造成裹挟的湿气蒸发，并破坏环氧玻璃在“接合点”（环氧玻璃布经线与纬线交叉处）的粘合。根据以往的经验，我们知道环氧玻璃会吸收大气中的湿气，当湿气含量超过0.3%（重量比）时，在浸焊/热风整平和/或组装焊接作业中会使白斑增加。

## Introduction (cont.) (引言 (续))

造成白斑/微裂纹状况的因素还有：树脂的成分、层压方法、耦合剂， $T_g$ 等。过去搜集到的报告显示，白斑和微裂纹范围超过间距的50%以上时，也不会影响硬件的可靠性。既然所有测试报告都显示白斑没有问题，而且没有使用失效的报告，为什么我们还如此顾虑白斑和微裂纹现象呢？因为理论上看来，如果导体之间布满白斑，同时伴有湿气或其他污染物，那么在导体之间应该存在铜的迁移（即绝缘电阻失效）。

尽管上文分析了潜在的失效机理，但出现这样的失效（绝缘电阻或迁移）几乎是不可能的。首先需要白斑填满导电图形之间。其次，印制板/组件内需要有潮气，并伴有导电的或离子的污染物，例如氯化物。

图23b图示了业界的一个典型实例，白斑位于两个镀通孔间的中心处（见图23b），其宽度为0.4mm[0.0157in]。要想使铜迁移成为可能，白斑必须占满两个镀覆孔之间的区域。这种情况当然是不太可能发生的。另一个案例（见图23c）图示了两个表面导体之间存在潜在失效机理的条件。它要求一根带正（+）电的导体刚好落在纤维交织点上，同时还要求另一个带负（-）电的导体也刚好落在纤维交织点上。要想这两个导体通过基材产生电气短路，需存在以下这样一条导电通路：从一个导电图形开始，经由尚存的介质材料（树脂和纤维）到分离点（白斑），沿着分离处向另一个导电图形的方向，再经过尚存的介质材料（树脂和纤维），最后到达另一个导电图形。上述条件均符合的情况下，还需要这两个相邻导体之间有压差。这是非常不可能的事情。这也是为什么业界至今尚无任何由于白斑造成可靠性问题的原因。

确定电子组件验收准则时，要考虑上述所有可能发生的情况。不应该把白斑看作不符合条件。应该将白斑看作为制程警示，它告诉你制程正面临失控的可能。纠正问题，而不是报废产品，分析上述种种可能，排查隐患。

#### Brief summary of the Third IPC Blue Ribbon Committee on Measles

In 2004, the issue of printed board laminate degradation caused by internal Conductive Anodic Filament (CAF) growth came to the forefront of discussions among the IPC printed board assembly standards groups (including the 7-31b IPC-A-610 and 5-22a National Standard for Soldering task groups.) It was observed that circuit density, operating speed, band pass and reduced operating voltage had impacted the ability of circuits to operate under conditions supporting dendrite or CAF development.

With the proliferation of finer line conductors and reduced spacing in current designs, discussions within the assembly standards groups questioned the role of measles within printed board laminate materials as a potential catalyst for CAF growth.

For years, IPC standards for electronic production contained no restrictions for the occurrence of measles in printed boards and/or assemblies. Theoretically, measles could be continuous between conductors and could exist throughout the printed board. It was noted that this allowance was based on studies conducted nearly 30 years earlier based on circuit designs from that time period. It was recognized that a need existed to reconsider the measles requirements for today's production designs and product environment.

In the interim, as a means to call attention to this potential problem, IPC assembly documents were changed to include pass/fail (defect) criteria for Class 3 assemblies that exhibited the visual appearance of measles.

The new measles criteria created in the assembly documents defined requirements that were stricter than those given in the printed board documents unless the additional IPC-6012, Class 3A (Military and Aerospace) requirements were considered. IPC-6012, Class 3A does not allow measles in bare boards for these industry segments, however Class 3 printed boards produced in accordance with 6012, which exhibited measles, were no longer acceptable for use in the assembly documents for Class 3 in general. This requirement conflict was brought to the attention of the IPC Technical Activities Executive Committee (TAEC) and that body directed both groups to work together to come to some resolution, based on test data that would bring the documents into agreement on the acceptance criteria.

The leadership of the printed board standards committees formed a new Blue Ribbon Committee on Measles and designed and performed testing to determine if measles contributed to CAF failures in actual end product. This test protocol was completed in late 2006 and presented to the printed board standards committees at IPC Printed Circuits Expo/APEX 2007. There was conclusive evidence within the test that measles did not contribute to CAF growth; nor did the presence of measles promote CAF failures in the end product that exhibited CAF.

## Introduction (cont.) (引言 (续))



图23a 微裂纹案例

注：此图仅用作说明状况，并不要求做显微剖切评价。

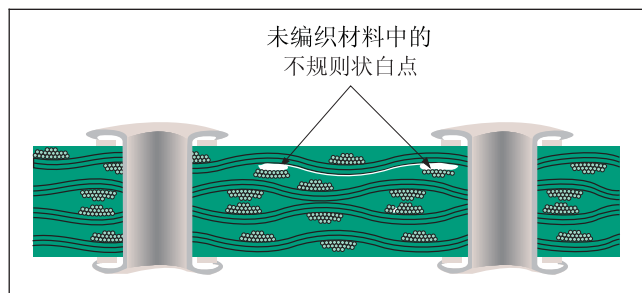

图23b 白斑跨接了导电图形的案例

注：此图仅用作说明状况，并不要求做显微剖切评价。

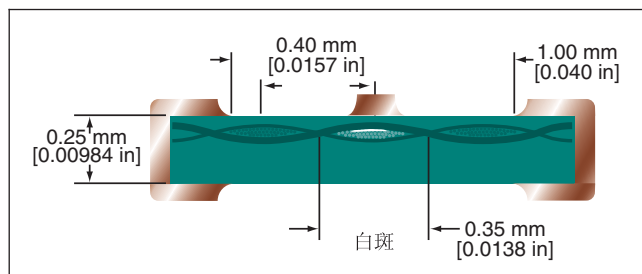

图23c 两个表面导体之间潜在失效机理的案例

注：此图仅用作说明状况，并不要求做显微剖切评价。

This presentation was then given to the assembly standards groups for their consideration. The request was made that the requirements in the bare printed board and assembly documents be changed to track with each other.

The leadership of the assembly standards groups concurred that the industry now had test data that addressed their original concerns regarding the potential of measles to promote CAF failures. They also agreed that the documents should be amended to eliminate the conflicting measles requirements. The groups jointly drafted the words, comments, and instructions for all documents regarding measles and these were presented to the committee membership at the 2007 IPC Midwest Conference. Copies of the test protocol summary are available through the IPC.

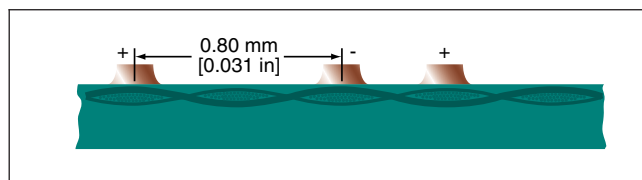
## 第三届IPC蓝带委员会关于白斑的概述

2004年，由于内部导电阳极丝（CAF）生长造成的印制板基材质量退化问题在IPC印制板组装标准工作组（包括7-31b IPC-A-610和5-22a国家焊接标准任务工作组）中成为了讨论的焦点。据观察，电路密度、运行速度、通带、工作电压的降低在有利于结晶或CAF生长的条件下均对电路的运行有影响。

随着电流设计中细线条导体的增加和导体间距的减少，组装标准工作组对印制板基材中白斑的作用提出了疑问，认为其是CAF生长的潜在催化剂。

多年来，IPC电子生产的标准中均未涵盖对印制板和/或组装板中白斑现象的限制。从理论上讲，白斑可能在导体之间连续呈现，也可能存在于整块印制板。大家注意到了这种允许规定是基于30年前在当时电路设计上的研究。大家认识到有需要针对当今的生产设计和产品环境重新考虑白斑的要求。

在此期间，为了引起对这一潜在问题的关注，IPC对组装文件作了变更，变更涵盖了对3级组装件中白斑外观的合格/不合格（缺陷）的准则。

除了考虑采用IPC-6012中3A级（军用和航空）要求，否则在组装文件中建立的关于白斑的新准则比印制板文件中规定的要求更严格。IPC-6012中3A级不允许在这些行业领域的裸板上出现白斑，但是，按照6012生产的3级印制板出现白斑时，如用于组装3级产品，通常是不可接受的。这一要求的矛盾引起了IPC技术活动执行委员会（TAEC）的关注，在该委员会的指导下，两个工作组一起努力找到了解决方案，根据测试数据，使文件中的验收准则达到一致。

在印制板标准委员会的领导下，成立了新的白斑蓝带委员会。该委员会设计并进行了实验以确定白斑是否是实际整机产品中CAF失效的原因。该实验程序于2006年后期完成，并于IPC 2007印制板展览会/APEX期间提交给印制板委员会。其测试的总结性证据说明白斑不是CAF生长的起因，也不是出现CAF的整机产品中CAF失效的促成原因。

该报告后期已提交给组装标准工作组，提请他们考虑更改组装文件，以使裸印制板文件和组装文件的要求互相一致。

组装标准工作组的领导一致同意，提出现在行业中已有测试数据解决了他们对潜在白斑引发CAF失效的最初顾虑。委员会同时同意对文件进行修订从而排除对白斑要求的矛盾之处。工作组联合起草了所有文件中关于白斑的文字、意见和建议，并于2007年IPC中西部会议期间提交给委员会成员。该测试程序总结可通过IPC获得。



### 2.3.1 Measling (白斑)

**Measling:** Measling manifests itself in the form of discrete white squares or “crosses” below the surface of the base material, and is usually related to thermally induced stress. Measles are subsurface phenomena that have been found in new laminated materials and in every board type made from woven fiber reinforced laminates at one time or another. Since measles are strictly subsurface phenomena and occur as a separation of fiber bundles at fiber bundle intersections, their apparent positions relative to surface conductors have no significance.

**白斑:** 白斑表现为基材表面下不连续的白色方块或“十字”纹，其形成通常与热应力有关。白斑是一种基材表面下现象，在新层压基材上和织物增强层压板制成的各种板上都时有发生。由于白斑绝对出现在表面下并且是在纤维束交叉处发生分离而出现，因此，其出现的位置相对于表面导体毫无意义。



图231a



图231b

注：此图仅用作说明状况，并不要求做显微剖切评价。



图231c

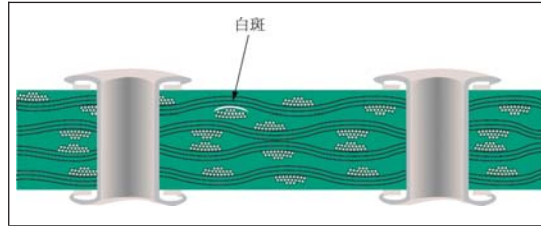

图231d

#### Target - Class 1,2,3 (目标条件 - 1,2,3级)

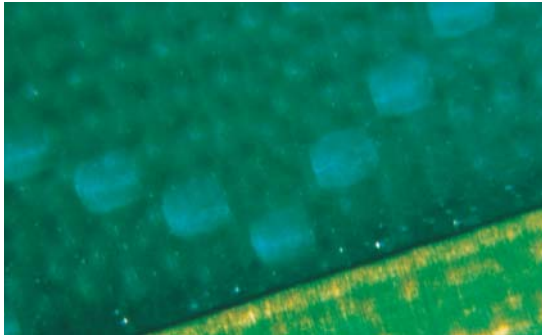
- No evidence of measling.
- 无白斑迹象。

#### Acceptable - Class 1,2 (可接受条件 - 1,2级)

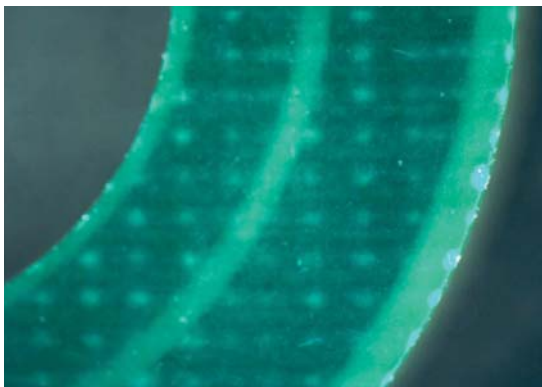
- The criteria for measling is that the printed board is functional.
- 对白斑的准则是印制板仍具有功能。

#### Process Indicator - Class 3 (制程警示 - 3级)

- Measled areas in laminate substrates exceed 50% of the physical spacing between noncommon conductors.
- 层压基材中白斑面积超过非公共导体之间实际间距的50%。

**Note:** Measling is an internal condition which does not propagate as a result of thermal testing that replicates future assembly processes and has not been conclusively shown to be a catalyst for CAF growth. Delamination is an internal condition which may propagate under thermal stress and may be a catalyst for CAF growth. The IPC-9691 user's guide for CAF resistance testing and IPC-TM-650, Method 2.6.25, provide additional information for determining laminate performance regarding CAF growth. Users who wish to incorporate additional criteria for measle conditions may consider incorporating the provisions of IPC-6012, Class 3A which does not allow measles.

注：白斑是层压板中的一种内部现象，不会由于模拟组装制程的热应力测试而扩展，同时也无明确结论显示它是阳极导电丝（CAF）生长的诱因。分层是一种在热应力作用下可能扩展的内部现象，也可能是CAF生长的诱因。关于耐CAF测试，IPC-9691用户指南和IPC-TM-650测试方法2.6.25均提供了确定层压板CAF生长性能的其他信息。希望加入白斑状况其他要求的用户可考虑纳入不允许白斑出现的3A级要求。

**Note:** Measles are observed from the surface. Cross-sections are for illustration purposes.

注：白斑可从表面观察。剖面图仅用于图示。



2.3.2 Crazing (微裂纹)

**Crazing:** An internal condition occurring in the laminated base material in which the fibers within the yarn are separated. This can occur at the weave intersections or along the length of the yarn. This condition manifests itself in the form of connected white spots or “crosses” below the surface of the base material, and is usually related to mechanically induced stress. When the crosses are connected the condition is evaluated as follows:

**微裂纹:** 层压基材内纤维发生分离的一种内部状况。微裂纹可在纤维交织处或沿纤维丝长度方向出现。微裂纹状况表现为基材表面下相连的白点或“十字纹”，通常与机械应力有关。当十字纹相互连接时，微裂纹状况评定如下：



图232a



图232b

注：此图仅用作说明状况，并不要求做显微剖切评价。

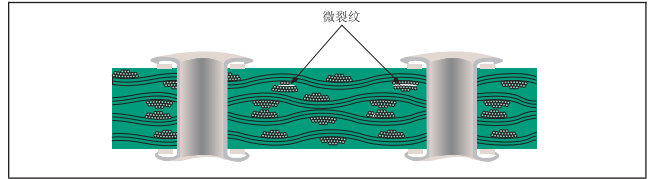

图232c

**Target Condition - Class 1,2,3 (目标条件 - 1,2,3级)**

- No evidence of crazing.
- 无微裂纹迹象。

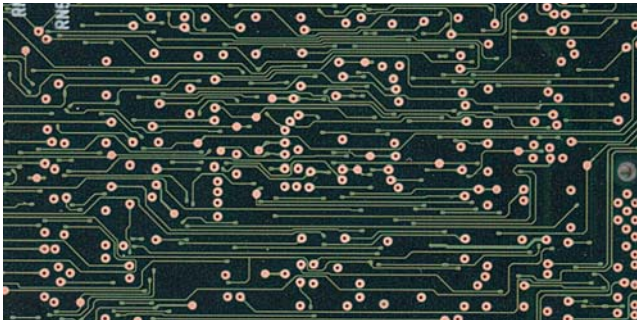

图232d

**Acceptable - Class 2,3 (可接受条件 - 2,3级)**

- The imperfection does not reduce the conductor spacing below the minimum.
- The distance of crazing does not span more than 50% of the distance between adjacent conductive patterns that are not electrically common.
- No propagation as a result of thermal testing that replicates the manufacturing process.
- Crazing at the edge of the printed board does not reduce the minimum distance between printed board edge and conductive pattern; or more than 2.5 mm [0.0984 in] if not specified.
- 瑕疵未使导体间距减少至低于最小导体间距。
- 微裂纹的跨距不大于相邻非电气共接导电图形之间距离的50%。
- 没有因为模拟制造过程的热测试而扩大。
- 印制板边的微裂纹未减少板边与导电图形间的最小距离，若未规定最小距离时，则微裂纹不大于2.5mm[0.0984in]。

**Note:** Crazing is observed from the surface. Cross-sections are for illustration purposes only.

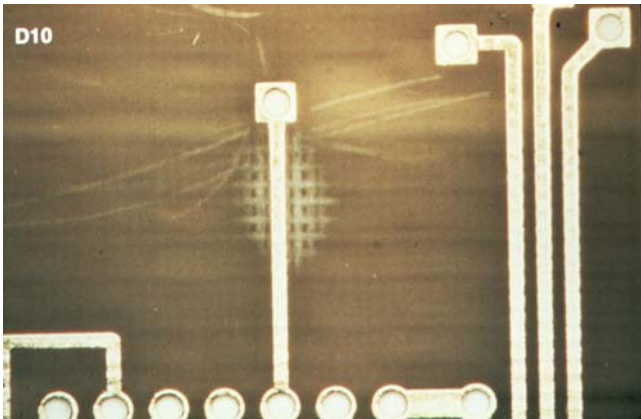
注：微裂纹可从表面观察。剖面图仅用于图示。

## 2.3.2 Crazeing (cont.) (微裂纹 (续))

### Acceptable - Class 1 (可接受条件 - 1级)

- The imperfection does not reduce the conductor spacing below the minimum.
- No propagation as a result of thermal testing that replicates the manufacturing process.
- Crazeing at the edge of the printed board does not reduce the minimum distance between printed board edge and conductive pattern; or more than 2.5 mm [0.0984 in] if not specified.
- 瑕疵未使导体间距减少至低于最小导体间距。
- 没有由于模拟制造过程的热测试而扩大。
- 印制板边的微裂纹未减少板边与导电图形间的最小距离，若未规定最小距离时，则微裂纹不大于2.5mm[0.0984in]。



图232e

### Nonconforming - Class 1,2,3 (不符合条件 - 1,2,3级)

- Defects either do not meet or exceed above criteria.
- 缺陷不符合或超出上述要求。

## 2.3.3 Delamination/Blister (分层/起泡)

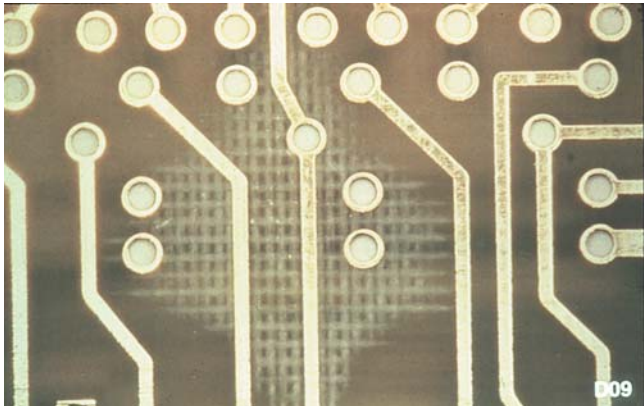
**Delamination:** A separation between plies within a base material, between a material and conductive foil, or any other planar separations within a printed board.

**分层:** 出现在基材内的层与层之间、基材与导电箔之间，或印制板任何其它层内的分离现象。

**Blister:** Delamination in the form of a localized swelling and separation between any of the layers of a lamination base material, or between base material and conductive foil or protective coating.

**起泡:** 表现为层压基材的任意层之间或者基材与导电箔或保护性涂覆层之间的局部膨胀和分离的分层。



图233a

注：此图仅用作说明状况，并不要求做显微剖切评价。



图233b

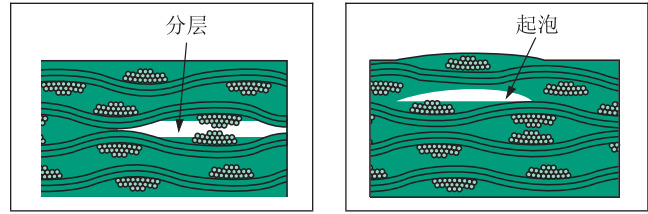

图233c

**Target Condition - Class 1,2,3 (目标条件 - 1,2,3级)**

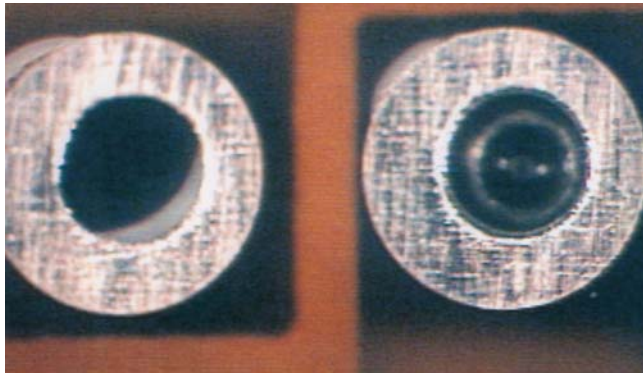
- No blistering or delamination.
- 无起泡或分层。

**Acceptable - Class 2,3 (可接受条件 - 2,3级)**

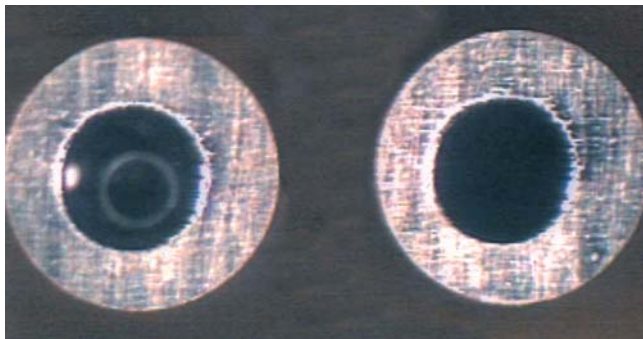
- The area affected by imperfections does not exceed 1% of the printed board area on each side.
- The imperfection does not reduce the space between conductive patterns below the minimum conductor spacing.
- The blister or delamination does not span more than 25% of the distance between adjacent conductive patterns.
- No propagation as a result of thermal testing that replicates the manufacturing process.
- The imperfection does not exceed the specified minimum distance between printed board edge and conductive pattern, or 2.5 mm [0.0984 in] if not specified.
- 受瑕疵影响的面积不超过印制板每面面积的1%。
- 瑕疵没有使导电图形间的间距减少至低于最小导体间距。
- 起泡或分层的跨距不大于相邻导电图形之间距离的25%。
- 没有由于模拟制造制程的热应力测试而扩大。
- 瑕疵未减少板边与导电图形间规定的最小距离，若未规定最小距离时，则微裂纹不大于2.5mm[0.0984in]。

### 2.3.3 Delamination/Blister (cont.) (分层/起泡 (续))



图233d

#### Acceptable - Class 1 (可接受条件 - 1级)

- The area affected by imperfections does not exceed 1% of the printed board area on each side.
- The blister or delamination spans more than 25% of the distance between conductors, but does not reduce the space between conductor patterns below the minimum conductor spacing.
- No propagation as a result of thermal testing that replicates the manufacturing process.
- The imperfection does not exceed the specified minimum distance between printed board edge and conductive pattern, or 2.5 mm [0.0984 in] if not specified.
- 受瑕疵影响的面积不能超过印制板每面面积的1%。
- 起泡或分层跨距大于相邻导体间距的25%，但没有使导电图形间的间距减小到至低于最小导体间距。
- 没有由于模拟制造制程的热应力测试而扩大。
- 瑕疵未超过印制板边缘与导电图形间规定的最小距离，若未规定最小距离时，则微裂纹不大于2.5mm[0.0984in]。

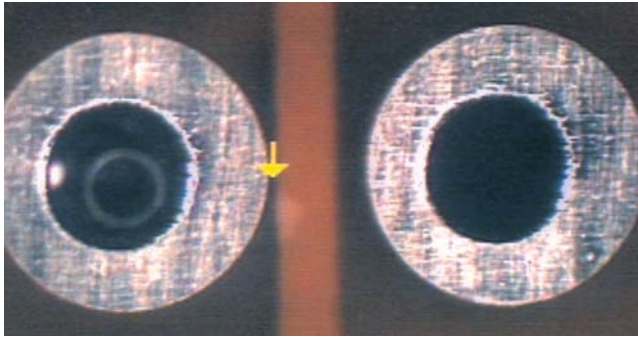

图233e

#### Nonconforming - Class 1,2,3 (不符合条件 - 1,2,3级)

- Defects either do not meet or exceed above criteria.
- 缺陷不符合或超出上述要求。

**Note:** The area affected is determined by combining the area of each imperfection and dividing by the total area of the printed board. A separate determination is made for each side.

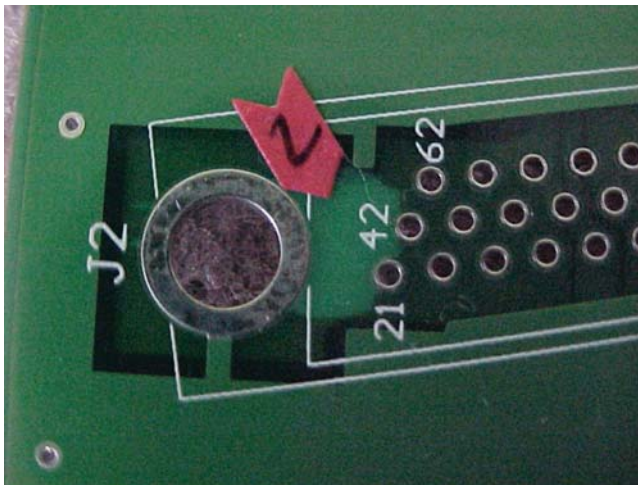
**注:** 受影响的面积，是由各瑕疵面积的总和除以印制板的总面积来确定的。要分别确定每面受影响面积的百分比。



## 2.3.4 Foreign Inclusions (外来夹杂物)

**Foreign Particles:** Metallic or nonmetallic, which may be entrapped or embedded in an insulating material.

Foreign material may be detected in raw laminate, B stage, or processed multilayer printed boards. The foreign objects may be conductive or nonconductive, and both types may be nonconforming depending on size and location.

**外来夹杂物:** 是指夹裹或埋在绝缘材料内的金属或非金属微粒。

外来夹杂物可以在基板原材料、预浸材料 (B阶)、或已制成的多层印制板中被检测出来。外来物可能是导体也可能是非导体,这两种情况均依据其大小及所在部位置来确定是否为不符合条件。



图234a

### Target Condition - Class 1,2,3 (目标条件 - 1,2,3级)

- No foreign inclusions.
- 无外来夹杂物。

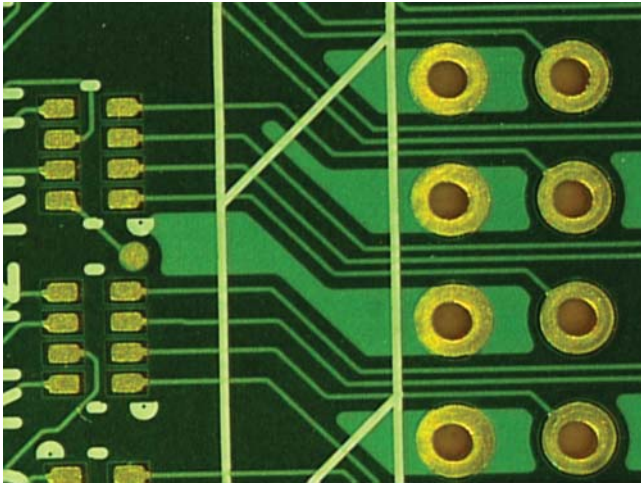

图234b

### Acceptable - Class 1,2,3 (可接受条件 - 1,2,3级)

- Translucent particles trapped within the printed board.
- Opaque particles trapped within the printed board which do not reduce the spacing between adjacent conductors to below the minimum spacing specified in the IPC-6010 series.
- Electrical parameters of the printed board are unaffected.
- 夹裹在板内的半透明微粒是可接受的。
- 板内夹裹有不透明微粒,但没有使相邻导体间距减小至低于IPC-6010系列文件规定的最小间距。
- 印制板的电气参数未受影响。

### 2.3.4 Foreign Inclusions (cont.) (外来夹杂物 (续))



图234c

#### Nonconforming - Class 1,2,3 (不符合条件 - 1,2,3级)

- Defects either do not meet or exceed above criteria.
- 缺陷不符合或超出上述要求。

## 2.4.1 Nonwetting (不润湿)

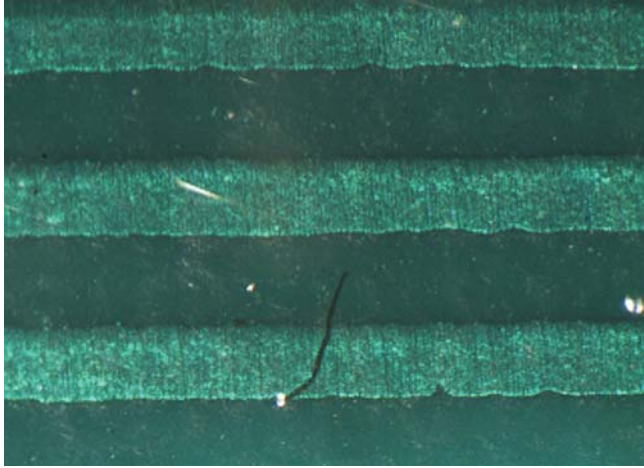
**Nonwetting:** The inability of molten solder to form a metallic bond with the basis metal.

**不润湿:** 熔融的焊料不能与金属基材形成金属键合。



图241a

注：此图仅用作说明状况，并不要求做显微剖切评价。



图241b

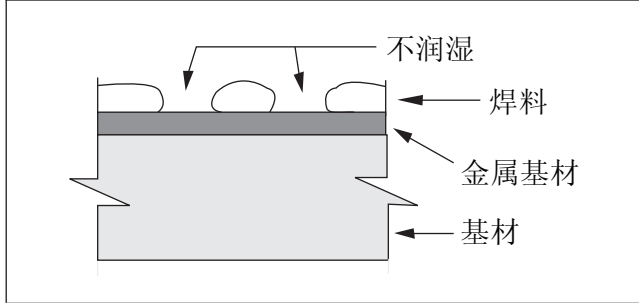

图241c

### Target Condition - Class 1,2,3 (目标条件 - 1,2,3级)

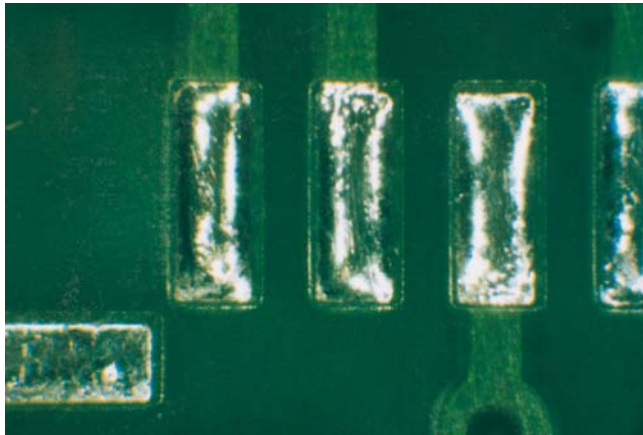
- No nonwetting.
- 无不润湿。

### Acceptable - Class 1,2,3 (可接受条件 - 1,2,3级)

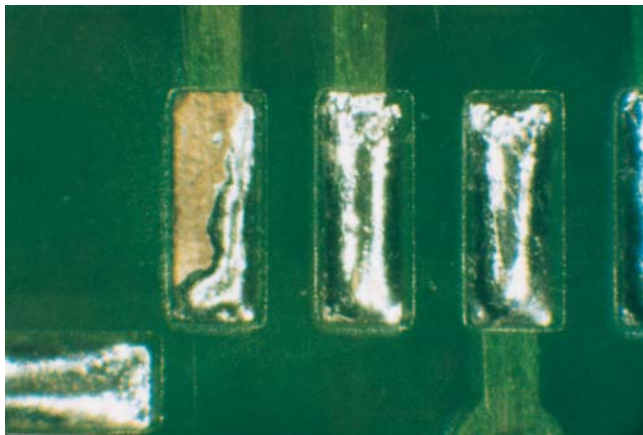
- Complete wetting on all conductive surfaces where solder is not excluded by mask or other plating finish. Vertical sides (conductor and land) areas may not be covered.
- 未被阻焊膜或其他镀层涂覆层覆盖的所有导电表面被焊料完全润湿。垂直面（导体和焊盘）区域可以不被覆盖。

### Nonconforming - Class 1,2,3 (不符合条件 - 1,2,3级)

- Defects either do not meet or exceed above criteria.
- 缺陷不符合或超出上述要求。

## 2.4.2 Dewetting (退润湿)

**Dewetting:** A condition that results when molten solder coats a surface and then recedes to leave irregularly-shaped mounds of solder that are separated by areas that are covered with a thin film of solder and with the basis metal not exposed.

**退润湿:** 熔融焊料涂覆在金属表面上然后焊料回缩, 导致形成由焊料薄膜覆盖且未暴露金属基材或表面涂覆层的区域分隔开的不规则焊料堆的一种状况。



图242a

注: 此图仅用作说明状况, 并不要求做显微剖切评价。

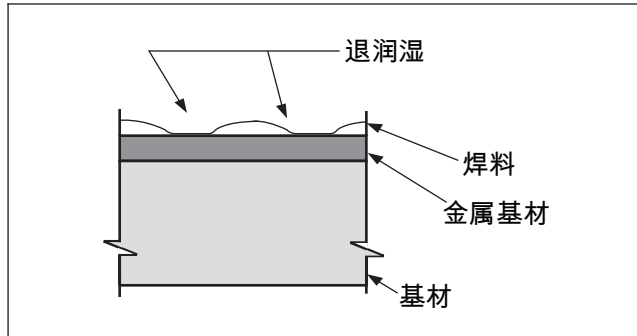

图242b

### Target Condition - Class 1,2,3 (目标条件 - 1,2,3级)

- No dewetting.
- 无退润湿。

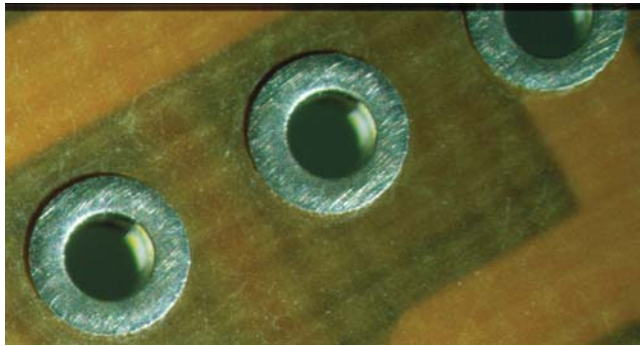

图242c

### Acceptable - Class 2,3 (可接受条件 - 2,3级)

- On conductors and ground or voltage planes.
- On 5% or less of each land area for solder connection.
- 导体上和接地层或电源层上有退润湿。
- 每个焊接连接盘上退润湿的面积小于或等于5%。

### Acceptable - Class 1 (可接受条件 - 1级)

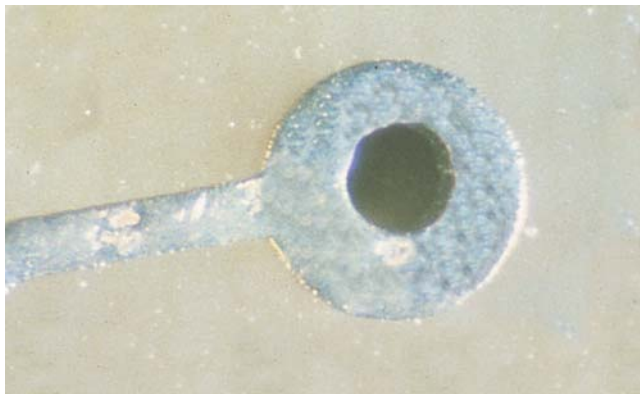
- On conductors and ground or voltage planes.
- On 15% or less of each land area for solder connection.
- 导体上和接地层或电源层上有退润湿。
- 每个焊接连接盘上退润湿的面积小于或等于15%。



## 2.4.2 Dewetting (cont.) (退润湿 (续))



图242d

### Nonconforming - Class 1,2,3 (不符合条件 - 1,2,3级)

- Defects either do not meet or exceed above criteria.
- 缺陷不符合或超出上述要求。

### 2.5.1 Nodules/Burrs (结瘤/毛刺)

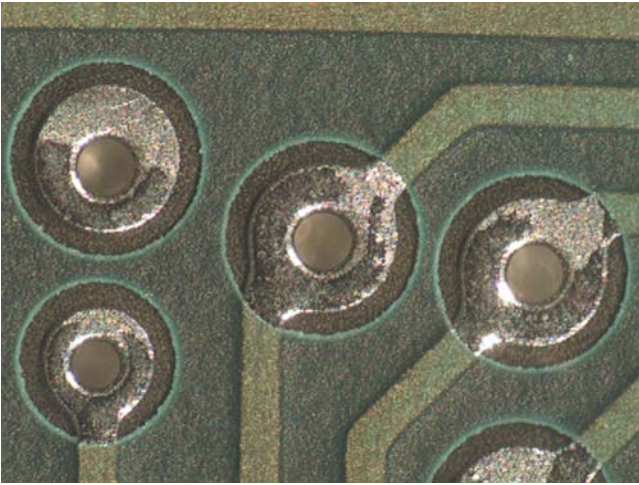

图251a

**Target Condition - Class 1,2,3 (目标条件 - 1,2,3级)**

- No evidence of nodules or burrs.
- 无结瘤或毛刺迹象。

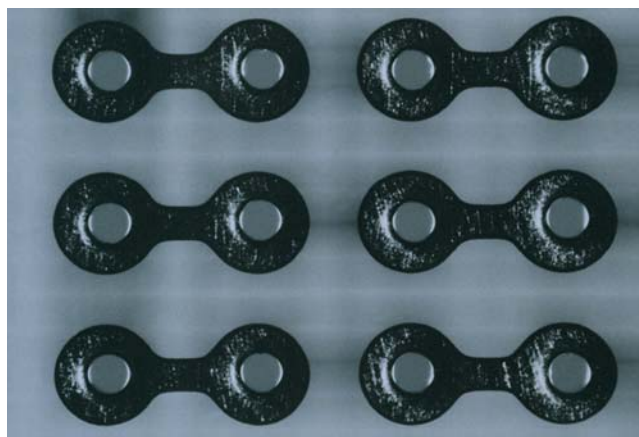

图251b

**Acceptable - Class 1,2,3 (可接受条件 - 1,2,3级)**

- Allowed if minimum finished hole diameter is met.
- 如能满足成品最小孔径的要求，则结瘤或毛刺是允许的。



图251c

**Nonconforming - Class 1,2,3 (不符合条件 - 1,2,3级)**

- Defects either do not meet or exceed above criteria.
- 缺陷不符合或超出上述要求。

## 2.5.2 Pink Ring (粉红圈)

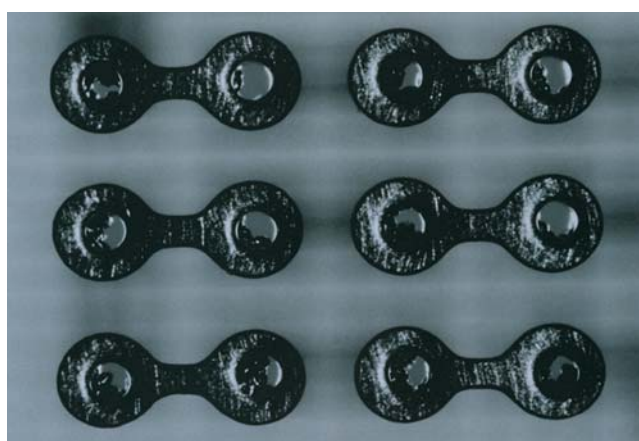

图252a

### Acceptable - Class 1,2,3 (可接受条件 - 1,2,3级)

- No evidence exists that pink ring affects functionality. The presence of pink ring may be considered a process indicator but is not nonconforming. The focus of concern should be the quality of the lamination bond and hole cleaning and conditioning processes.
- 没有证据表明粉红圈会影响印制板的功能。粉红圈的出现可将其考虑为制程警示，但不是不符合状况。应该将关注的焦点放在层压粘接和孔的清洗与处理制程的质量上。

### 2.5.3 Voids – Copper Plating (铜镀层空洞)

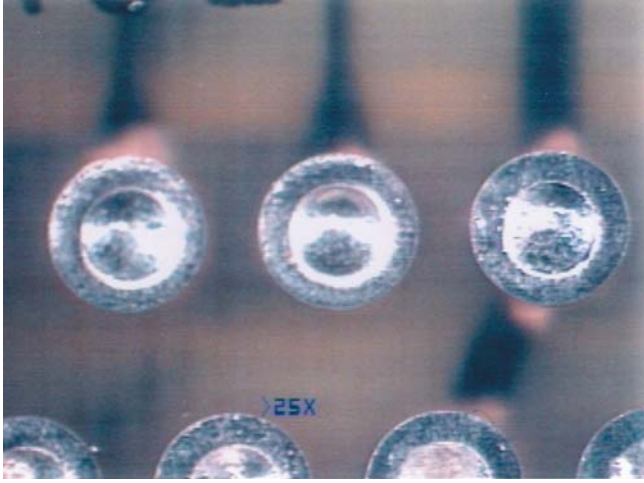

图253a

**Target Condition - Class 1,2,3 (目标条件 - 1,2,3级)**

- No voids.
- 无空洞。

**Acceptable - Class 3 (可接受条件 - 3级)**

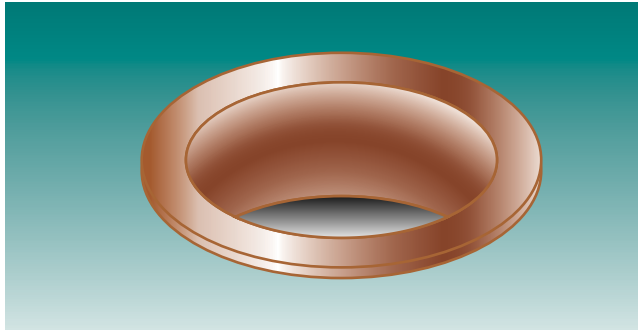
- No evidence of voids in the hole.
- 孔内无空洞迹象。



图253b

**Acceptable - Class 2 (可接受条件 - 2级)**

- No more than one void in any hole.
- Not more than 5% of the holes have voids.
- Any void is not more than 5% of the hole length.
- The void is less than 90° of the circumference.
- 任一孔内空洞数不多于1个。
- 含空洞的孔数不超过5%。
- 任一空洞的长度不大于其孔长的5%。
- 空洞小于圆周的90°。

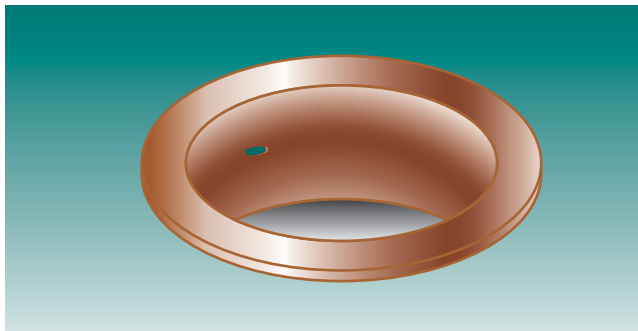

图253c

**Acceptable - Class 1 (可接受条件 - 1级)**

- No more than three voids in any hole.
- Not more than 10% of the holes have voids.
- Any void is not more than 10% of the hole length.
- All voids are less than 90° of the circumference.
- 任一孔内空洞数不多于3个。
- 含空洞的孔数不超过10%。
- 任一空洞长度不大于其孔长的10%。
- 所有的空洞均小于圆周的90°。

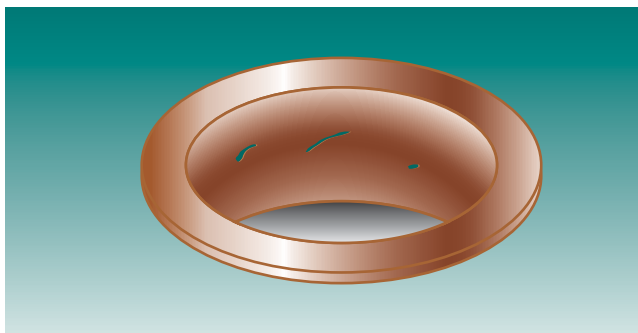

图253d

**Nonconforming - Class 1,2,3 (不符合条件 - 1,2,3级)**

- Defects either do not meet or exceed above criteria.
- 缺陷不符合或超出上述要求。

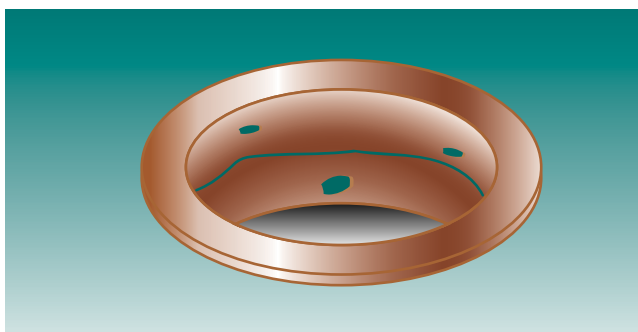

## 2.5.4 Voids – Finished Coating (最终涂覆层空洞)



图254a

### Target Condition - Class 1,2,3 (目标条件 - 1,2,3级)

- No voids.
- 无空洞。

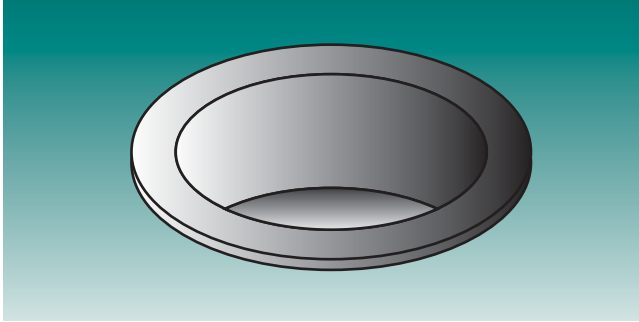

图254b

### Acceptable - Class 3 (可接受条件 - 3级)

- No more than one void in any hole.
- Not more than 5% of the holes have voids.
- The void is not more than 5% of the hole length.
- The void is less than 90° of the circumference.
- 任一孔内空洞数不多于1个。
- 含空洞的孔数不超过5%。
- 空洞长度不大于其孔长的5%。
- 空洞小于圆周的90°。

### Acceptable - Class 2 (可接受条件 - 2级)

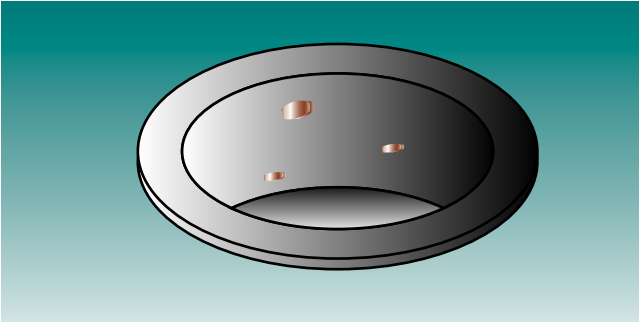
- No more than three voids in any hole.
- Not more than 5% of the holes have voids.
- Any void is not more than 5% of the hole length.
- All voids are less than 90° of the circumference.
- 任一孔内空洞数不多于3个。
- 含空洞的孔数不超过5%。
- 任一空洞长度不大于其孔长的5%。
- 所有空洞小于圆周的90°。



图254c

### Acceptable - Class 1 (可接受条件 - 1级)

- No more than five voids in any hole.
- Not more than 15% of the holes have voids.
- Any void is not more than 10% of the hole length.
- All voids are less than 90° of the circumference.
- 任一孔内空洞不多于5个。
- 含空洞的孔数不超过15%。
- 空洞长度不大于其孔长的10%。
- 所有空洞小于圆周的90°。

### Nonconforming - Class 1,2,3 (不符合条件 - 1,2,3级)

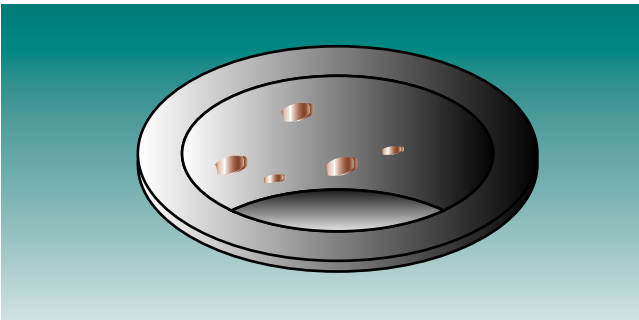
- Defects either do not meet or exceed above criteria.
- 缺陷不符合或超出上述要求。

## 2.5.5 Lifted Lands – (Visual) (焊盘起翘 – (目检))



图255a

**Target Condition/Acceptable - Class 1,2,3**  
(目标条件/可接受条件 - 1,2,3级)

- No lifting of lands.
- 无焊盘起翘。



图255b

**Nonconforming - Class 1,2,3** (不符合条件 - 1,2,3级)

- Defects either do not meet or exceed above criteria.
- 缺陷不符合或超出上述要求。

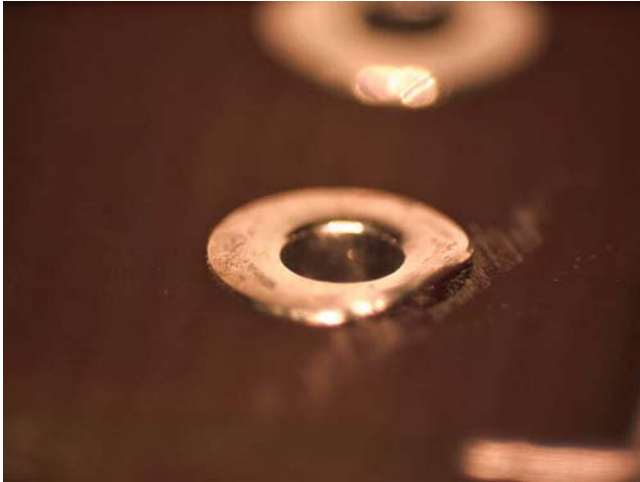

图255c

2.5.6 Cap Plating of Filled Holes – (Visual) (填充孔的盖覆电镀 – (目检))

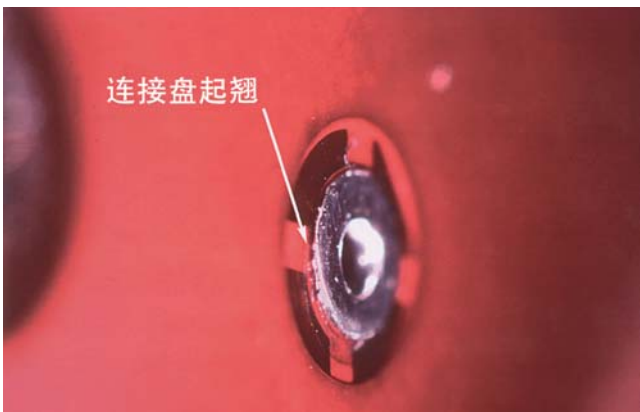

图256a

Target Condition - Class 1,2,3 (目标条件 - 1,2,3级)

- Copper surface is planar with no indication of cap plating.
- 铜表面平整，无盖覆电镀的迹象。

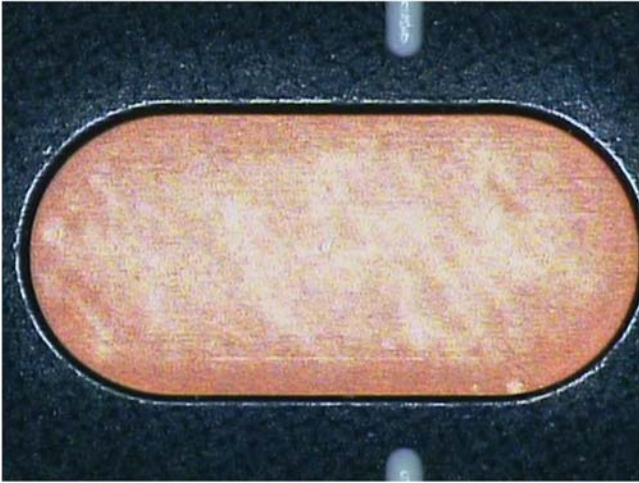

图256b

Acceptable - Class 1,2,3 (可接受条件 - 1,2,3级)

- When cap plating of the filled via is specified on the procurement documentation, the requirements of 2.7.1.1 and the requirements of the applicable performance specification for rectangular and round surface mount pads **shall** apply.
- No plating voids exposing the resin fill area, unless covered by solder mask.
- Visually discernable protrusions (bumps) and/or depressions (dimples) that meet the microsection requirements of the applicable performance specification.
- 当采购文件中规定盖覆电镀填充孔时，矩形和圆形表面贴装焊盘应当采用2.7.1.1节的要求和适用的性能规范要求。
- 除非被阻焊膜覆盖，否则不能有暴露树脂填充区域的镀层空洞。
- 目视可辨识的凹陷（凹坑）和凸起（凸块）满足适用的性能规范中显微切片的要求。

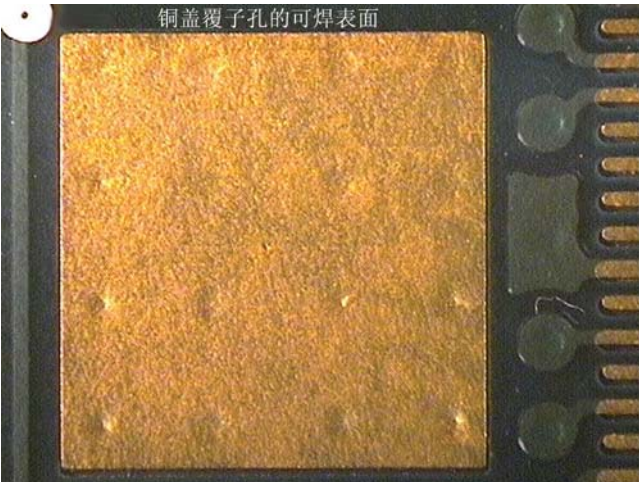

图256c

2.5.6 Cap Plating of Filled Holes – (Visual) (cont.) (堵塞孔的盖覆电镀 – (目检) (续))

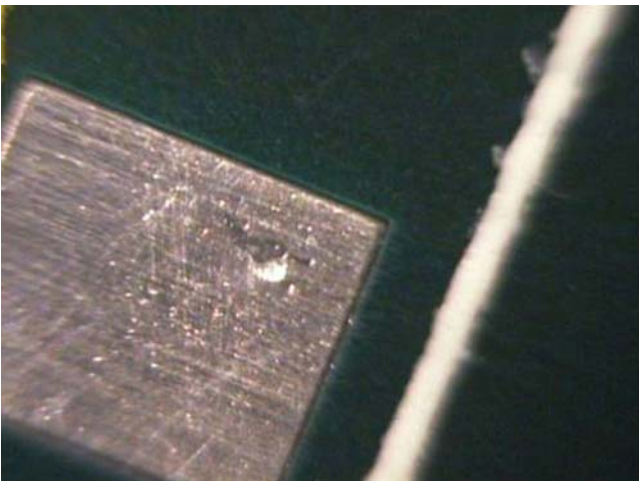

图256d

**Nonconforming - Class 1,2,3 (不符合条件 - 1,2,3级)**

- Defects either do not meet or exceed above criteria.
- 缺陷不符合或超出上述要求。

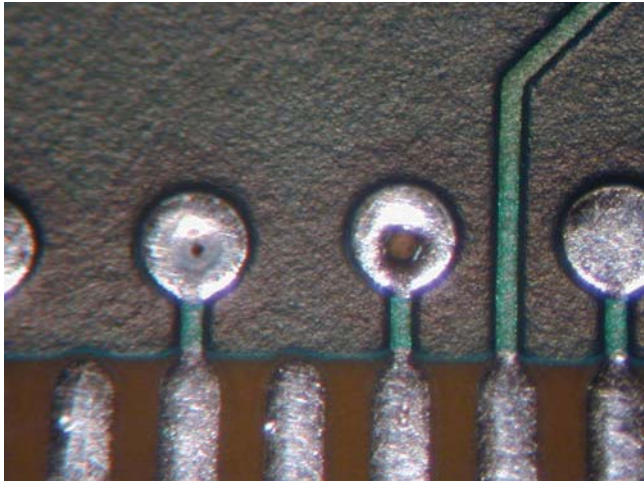

## 2.6.1 Haloing (晕圈)

**Haloing:** Mechanically induced fracturing or delamination on or below the surface of the base material; a light area around the holes, other machined areas or both are usually indications of haloing. See also 2.1.3.

**晕圈:** 由于机械加工引起的基材表面上或表面下的破裂或分层现象；通常表现为在孔周围或其它机械加工的部位呈现泛白区域，或两处同时存在。又见2.1.3节。



图261a

**Target Condition - Class 1,2,3 (目标条件 - 1,2,3级)**

- No haloing.
- 无晕圈。

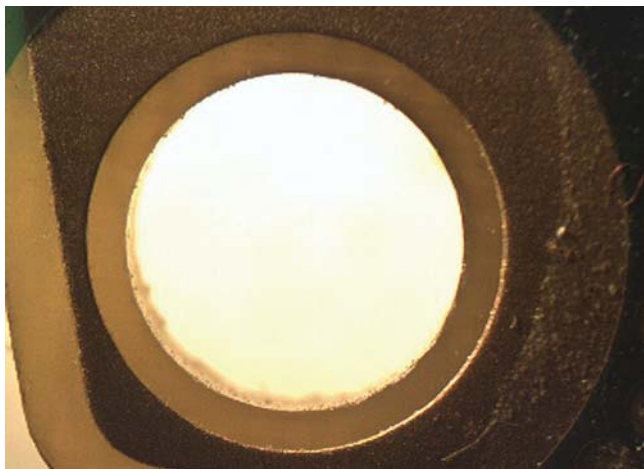

图261b

**Acceptable - Class 1,2,3 (可接受条件 - 1,2,3级)**

- Distance between the haloing penetration and the nearest conductive feature is not less than the minimum lateral conductor spacing, or 100  $\mu\text{m}$  [3,937  $\mu\text{in}$ ] if not specified.
- 晕圈渗透与最近导电图形间的距离不小于最小侧向导体间距，如未规定，则不小于100 $\mu\text{m}$ [3,937 $\mu\text{in}$ ]。

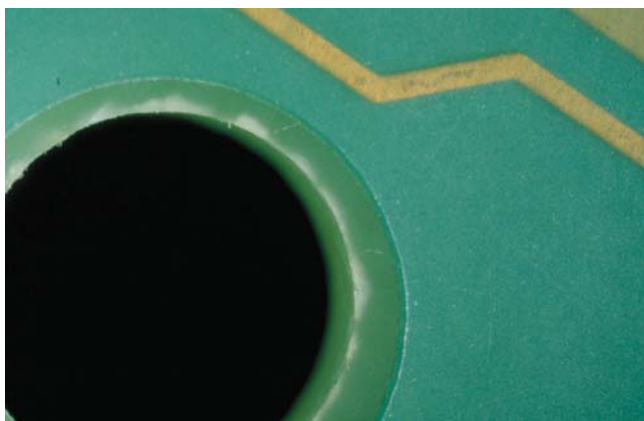

图261c

**Nonconforming - Class 1,2,3 (不符合条件 - 1,2,3级)**

- Defects either do not meet or exceed above criteria.
- 缺陷不符合或超出上述要求。

2.7.1 Surface Plating – Plated Contacts (表面镀层 – 电镀的接触片)



图271a



图271b

**Target Condition - Class 1,2,3 (目标条件 - 1,2,3级)**

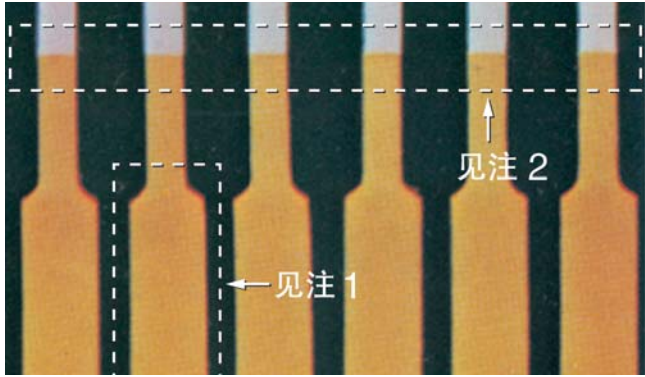
- Contacts are free of pits, pinholes and surface nodules.
- No exposed copper or plating overlap between solder finish or solder mask and tip finish.
- 接触片上没有麻点、针孔和表面结瘤。
- 焊料涂覆层或阻焊膜与接触片末端涂覆层之间既没有露铜也没有涂层重叠。

**Acceptable - Class - 1,2,3 (Critical Contact Area)**

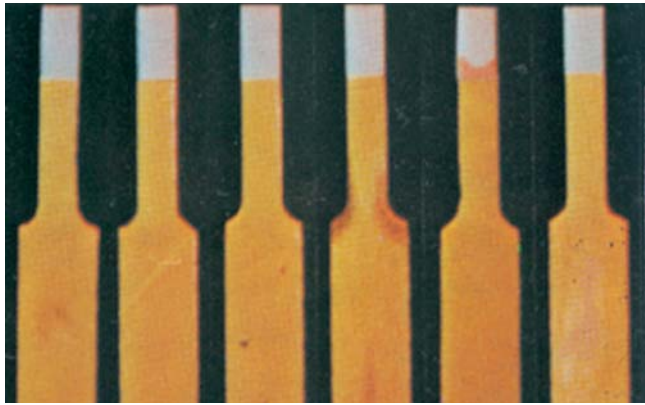
(可接受条件 - 1,2,3级 (关键接触区))

- Surface defects do not expose underlying metal in critical contact area.
- Solder splashes or tin-lead plating does not occur in critical contact area.
- No nodules and metal bumps in critical contact area.
- Pits, dents or depressions do not exceed 0.15 mm [0.00591 in] in their longest dimension. There are not more than three per contact, and they do not appear on more than 30% of the contacts.
- 在接插关键区内表面缺陷没有曝露底层金属。
- 在接插关键区内没有溅出的焊料或锡铅镀层。
- 在接插关键区内没有结瘤和金属突出。
- 麻点、凹坑或凹陷处的最长尺寸不超过0.15mm[0.00591in]。每个接触片上的缺陷不超过3处，且有这些缺陷的接触片不超过接触片总数的30%。

**Acceptable - Class 3 (Gap/Overlap Area)**

(可接受条件 - 3级 (露铜/重叠区域))

- Exposed copper or plating overlap is 0.8 mm [0.031 in] or less.
- 露铜/镀层重叠区小于等于0.8mm[0.031in]。

**Acceptable - Class 2 (Gap/Overlap Area)**

(可接受条件 - 2级 (露铜/重叠区域))

- Exposed copper or plating overlap does not exceed 1.25 mm [0.04921 in].
- 露铜/镀层重叠区不超过1.25mm[0.04921in]。

**Acceptable - Class 1 (Gap/Overlap Area)**

(可接受条件 - 1级 (露铜/重叠区域))

- Exposed copper or plating overlap does not exceed 2.5 mm [0.0984 in].
- 露铜/镀层重叠区不超过2.5mm[0.0984in]。

**Note 1:** Discoloration is permitted in the plating overlap zone.

**Note 2:** Critical Contact Area. These conditions do not apply to a band 0.15 mm [0.00591 in] wide around the periphery of the printed contact land.

注1: 镀层重叠区允许变色。

注2: 关键接插区域。这些条件不适用于围绕包括印制接触焊盘周围0.15mm[0.00591in]宽的区域。

2.7.1 Surface Plating – Plated Contacts (cont.) (表面镀层 – 电镀的接触片 (续))



图271c

**Nonconforming - Class 1,2,3 (不符合条件 - 1,2,3级)**

- Defects either do not meet or exceed above criteria.
- 缺陷不符合或超出上述要求。

## 2.7.1.1 Surface Plating – Wire Bond Pads (表面镀层 – 金属线键合盘)

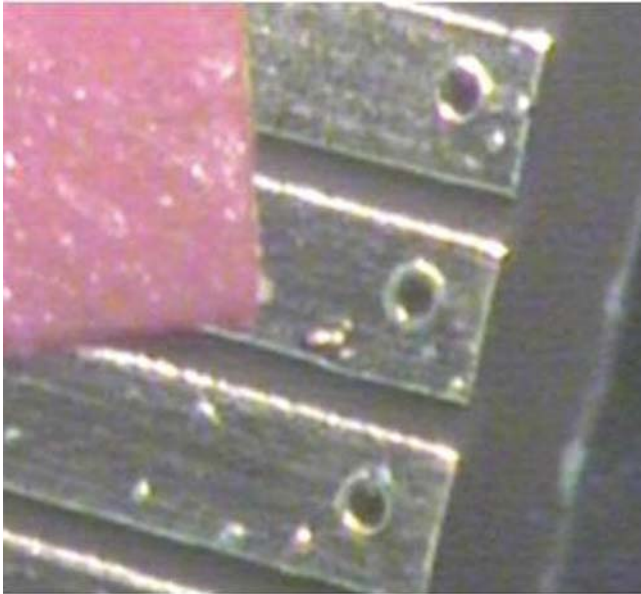

图2711a



图2711b 完好区域

## Target Condition - Class 1,2,3 (目标条件 - 1,2,3级)

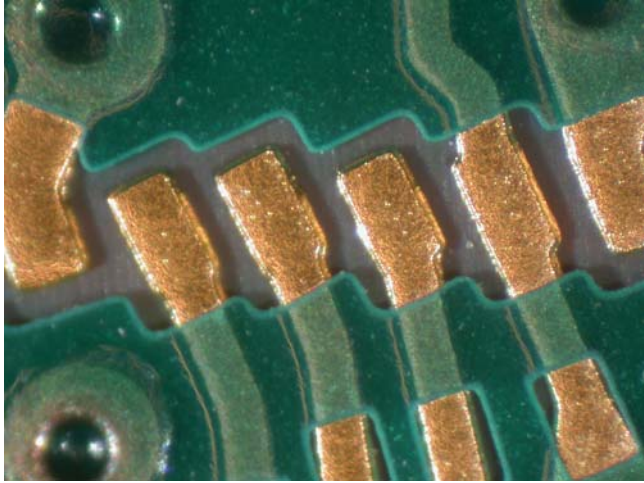
- Contacts are free of surface nodules, roughness, electrical test witness marks or scratches that exceed  $0.8 \mu\text{m}$  [ $32 \mu\text{in}$ ] RMS (root-mean-square) in the pristine area in accordance with an applicable test method AABUS. If IPC-TM-650, Method 2.4.15, is used, it is recommended that the roughness-width cutoff be adjusted to approximately 80% of the maximum length of the wire bond pad in order to obtain the RMS value within the pristine area. For more information on surface roughness, refer to ASME B46.1.
- The pristine area is defined as an area bounded in the center of the pad by 80% of the pad width and 80% of the pad length (see Figure 2711b).
- 依据供需双方协商确定的测试方法测试后，接触片在完好区域内没有超过 $0.8\mu\text{m}$ [ $32\mu\text{in}$ ]RMS（均方根值）的表面结瘤、粗糙、电气测试痕记或划痕。如使用IPC-TM-650测试方法2.4.15，为了获得完好区域内的均方根值，建议把粗糙度截除宽度调节至约为金属线键合盘最大长度的80%。关于表面粗糙度的更多信息请参考ASME B46.1。
- 完好区域的定义是以引线键合盘中心为基准，引线键合盘长度的80%和宽度的80%范围内的区域（见图2711b）。

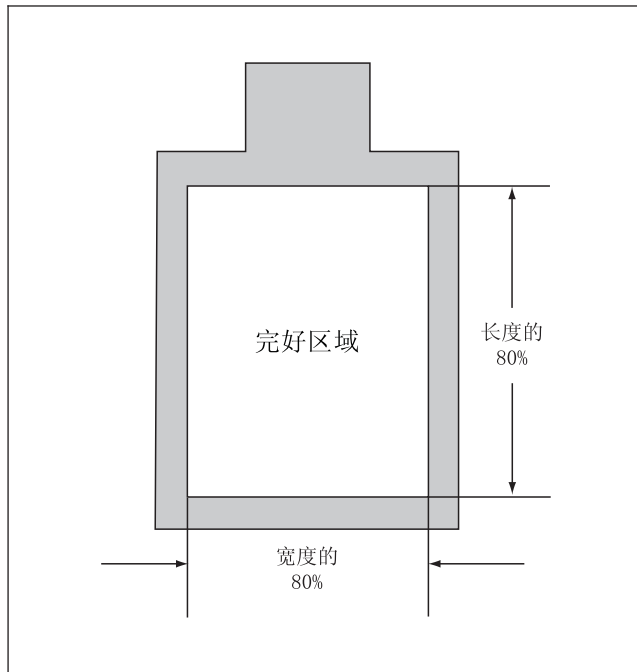

2.7.1.1 Surface Plating – Wire Bond Pads (cont.) (表面镀层 – 金属线键合盘 (续))



图2711c

**Nonconforming - Class 1,2,3 (不符合条件 - 1,2,3级)**

- Defects either do not meet or exceed above criteria.
- 缺陷不符合或超出上述要求。

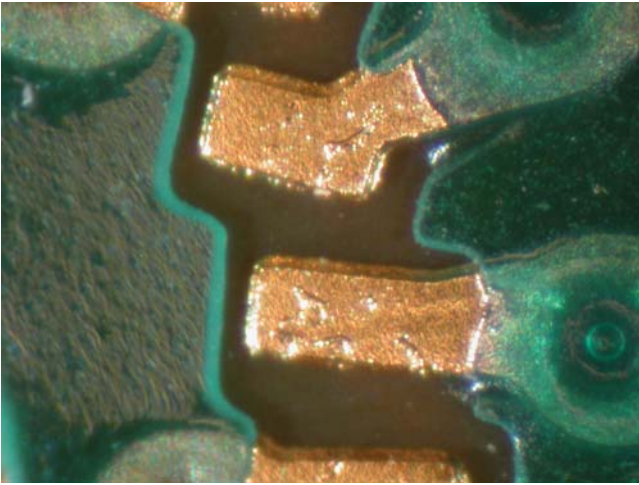

图2711d



图2711e

## 2.7.2 Burrs on Edge-Board Contacts (印制接触片 – 边缘毛刺)

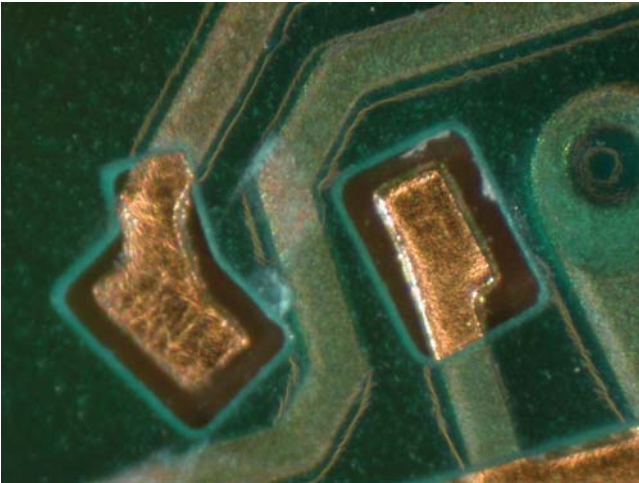

图272a

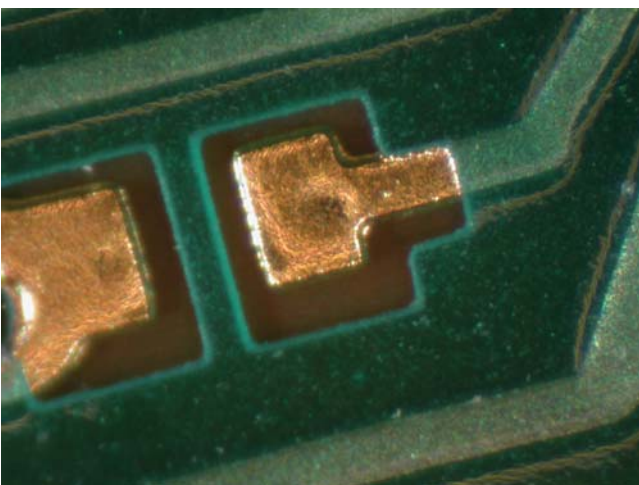

图272b

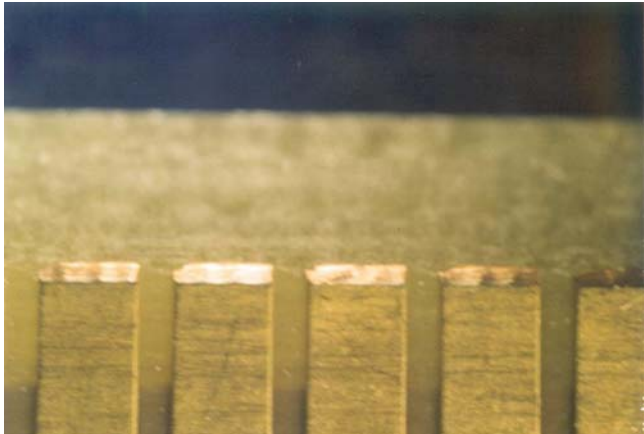

图272c

### Target Condition - Class 1,2,3 (目标条件 - 1,2,3级)

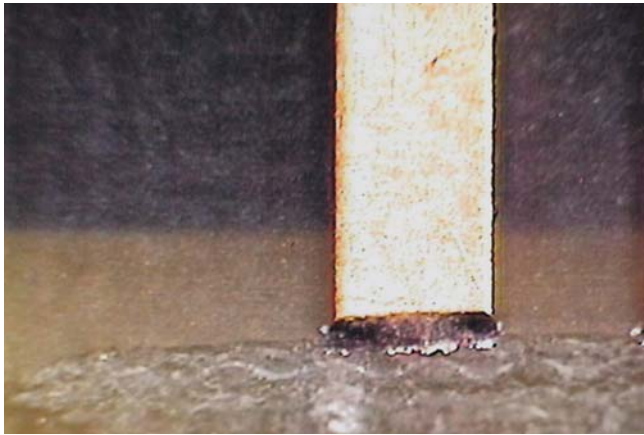
- Smooth edge condition.
- 边缘光滑。

### Acceptable - Class 1,2,3 (可接受条件 - 1,2,3级)

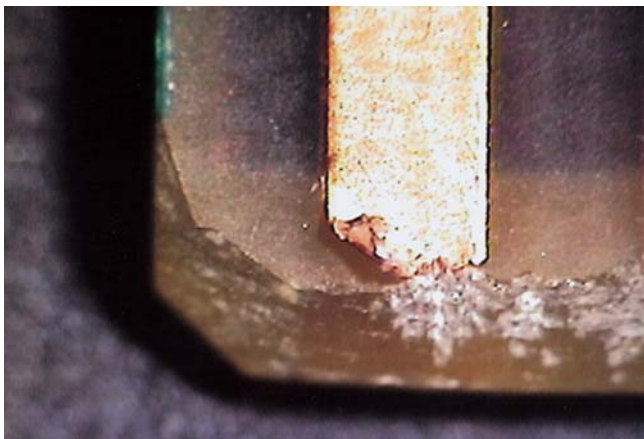
- Edge condition - smooth, no burrs, no rough edges, no lifted plating on printed contacts, no separation (delamination) of printed contacts from the base material, and no loose fibers on the beveled edge. Exposed copper at end of printed contact is expected and permissible.
- 边缘状况 - 平滑、无毛刺、无粗糙边缘、印制接触片的镀层不起翘，印制接触片与基材无分离（分层），接触片的倒角斜边上无松散的纤维。印制接触片末端允许露铜。

### Nonconforming - Class 1,2,3 (不符合条件 - 1,2,3级)

- Defects either do not meet or exceed above criteria.
- 缺陷不符合或超出上述要求。

## 2.7.3 Adhesion of Overplate (外镀层附着力)



图273a

## Target/Acceptable - Class 1,2,3 (目标/可接受条件 - 1,2,3级)

- Good plating adhesion as evidenced by tape test. No plating removed. If overhanging metal breaks off and adheres to the tape, it is evident of overhang or slivers, but not of plating adhesion failure. Figure 273b provides an example of overhanging metal.
- 经胶带测试证明镀层具有良好的附着力，没有镀层脱落。如果镀层突沿脱落并粘附到胶带上，则只说明有镀层突沿或镀屑，并非镀层附着力不良。图273b给出了突沿金属的实例示意图。

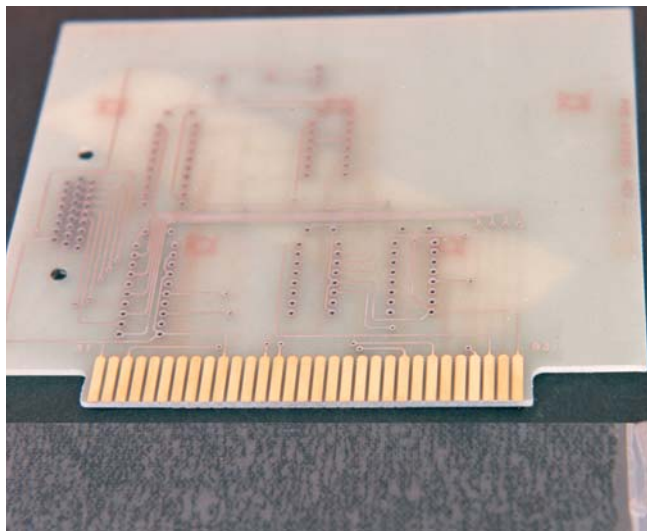

图273b

## Nonconforming - Class 1,2,3 (不符合条件 - 1,2,3级)

- Defects either do not meet or exceed above criteria.
- 缺陷不符合或超出上述要求。

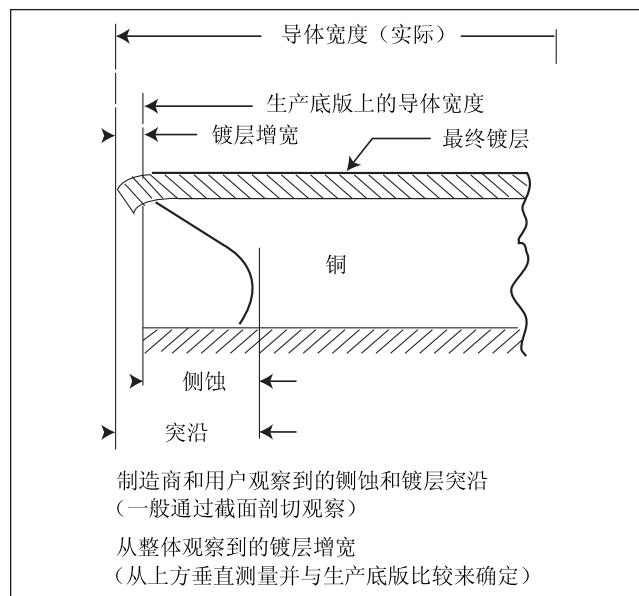

图273c

**Note 1:** The adhesion of the plating **shall** be tested in accordance with IPC-TM-650, Method 2.4.1, using a strip of pressure sensitive tape applied to the surface and removed by manual force applied perpendicular to the circuit pattern.

**Note 2:** Plating that has adhered to the tape.

**注1:** 镀层附着力应当按IPC-TM-650测试方法2.4.1进行测试，用一条压敏胶带压贴到镀层表面上，然后沿垂直于电路图形方向以手用力撕离胶带。

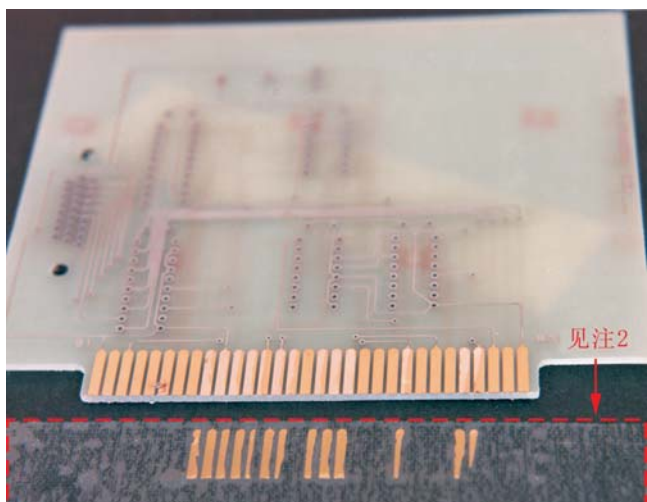
**注2:** 镀层粘附到胶带上。

## Introduction (引言)

This section covers acceptability criteria for marking of printed boards. Marking of printed boards provides a means of identification and aids in assembly. Legends screened over metal will generally degrade in a solder process or stringent cleaning environments. Legends over metal are not recommended. When use of legends over solderable surfaces is required, an etched legend is target condition. Minimum requirements should be specified on the procurement documentation. Examples of the marking addressed by this section are:

- Assembly or fabrication part numbers when a requirement of the procurement documentation. Each individual board, each qualification board, and each set of quality conformance test circuitry (as opposed to each individual coupon) **shall** be marked in order to ensure traceability between the boards/test circuitry and the manufacturing history and to identify the supplier (logo, etc.).
- Component insertion locators, when a requirement of the procurement documentation.
- Manufacturing sequence number when required by the work order.
- Revision letter when the part number is a requirement of the procurement documentation.
- Designator for test points or adjustment points.
- Polarity or clocking indicators.
- U.L. designator.

The procurement documentation (artwork) is the controlling document for location and type of marking. The procurement documentation revision letter to which the printed board is fabricated **shall** be marked on the board if part number marking is a requirement of the procurement documentation. Marking on printed boards **shall** withstand all tests, cleaning and compatible processes to which the printed boards are subjected and **shall** be legible (capable of being read and understood) as defined by the requirements of this document. **If a conductive marking is used, the marking shall be treated as a conductive element on the printed board and shall conform to IPC-4781.**

本节涵盖了印制板标记的可接受性准则。印制板的标记提供了识别的方法并在组装时提供帮助。网印在金属表面上的字符，通常会在焊接过程中或严酷的清洗之后变质。因此，不建议在金属表面上印字符。当需要在可焊表面制作字符时，蚀刻字符为目标条件。应该在采购文件中规定最低要求。本节所涉及的标记示例如下：

- 采购文件中要求的组装或制造部件号。每一块单独板、每一块鉴定测试板及每套质量一致性测试电路（相对于每块单独的附连板）均应当标识，以便追溯板/测试电路及制造历史，并识别供应商（商标等）。
- 采购文件中要求的元器件插装位置。
- 加工单中要求的制作顺序号。
- 采购文件中要求的部件号的版本字符。
- 测试点或调节点的指示符号。
- 极性 or 方位的指示符号。
- UL标志。

采购文件（照相底图）是规定标记位置和类型的控制文件。如果采购文件中要求标识部件号，则所制造的板上**应当**标记有该采购文件的版本字符。印制板上的标记**应当**能够经受所有的测试、清洗，并与其它工艺制程相兼容，并按本标准要求规定，在经受测试及有关制程后，板面上的标记**应当**仍可识别（能读出与理解）。**当采用导电标记时，应当把标记作为印制板上的导电要素对待，且应当符合IPC-4781。**



图28a



### Introduction (引言 (续))

The marking information on printed boards (part reference designations), **shall** be permanent and be capable of withstanding the environmental tests and cleaning procedures specified for the printed board. Marking **shall** be legible within the requirement of this document. The board **shall** be inspected at no greater magnification than 2X. When conductive inks are used they should meet the specifications of the IPC-6010 series.

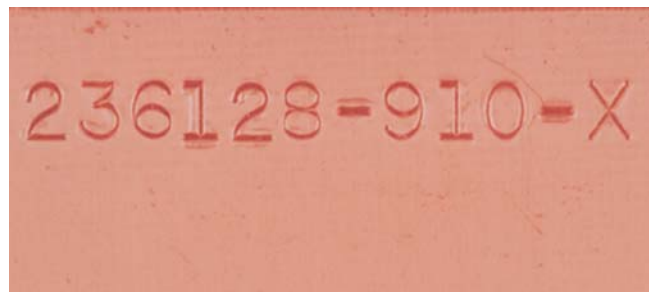
This section has general requirements for all marking (including laser, labels, bar coding, etc.) and specific criteria for the following types of marking:

- Etched Markings.
- Screened or Ink Stamped Markings.

Unless otherwise specified, each individual printed board, each qualification board, each set of quality conformance test circuitry (as opposed to each individual coupon) is marked in accordance with the procurement documentation, with the date code and manufacturer's identification (e.g., cage code for military, logo, etc.). The marking is produced by the same process as used in producing the conductive pattern, or by use of permanent fungistatic ink or paint, or by vibrating pencil marking on a metallic area provided for marking purposes or a permanently attached label. Conductive markings, either etched copper or conductive black ink are considered as electrical elements of the printed board and should not reduce the electrical spacing requirements. All markings are to be compatible with materials and parts, legible for all tests, and in no case affect board performance.

Although it is acceptable to use impression stamp markings on unused portions of panels, they are not allowed on finished printed boards. Engraved marking or impression stamps and any mark that cuts into the laminate is handled in the same manner as a scratch.

### Introduction (引言 (续))

印制板上的标记信息（部件代码）**应当**是永久性的，**应当**能经受住所规定的印制板环境测试和清洗程序。标记在本文件要求的范围内**应当**是清晰可读的。印制板**应当**在不大于2倍的放大倍数下进行检验。当采用导电油墨时，它们应该满足IPC-6010系列规范的要求。

本节（包括激光、标签、条形码等）规定了所有标记的通用要求，并对下列类型的标记规定了特殊准则：

- 蚀刻的标记
- 网印或盖印的标记

除非另有规定，每一块单独的印制板、每一块鉴定测试板、每套质量一致性测试电路（相对于每块单独的附连板而言）均要按照采购文件要求施加标记，包含有日期码和制造商的识别标记（如军用板的商业及政府机构代码或商标等）。制造标记可采用与生产导电图形相同的工艺，或采用永久性的有防霉性的油墨或油漆，也可以作为提供标记的目的而采用电笔在金属表面上作标记，或者贴附永久性的标签。导电性标记，不管是铜蚀刻的或黑色导电性油墨均视为电路的电气要素，它不应该降低电气间距的要求。所有标记都要与材料、部件相兼容，经各种测试后仍清晰可读，并在任何情况下都不可影响印制板的性能。

尽管在在制板的未使用部分用压印标记是可接受的，但不允许用在成品板上。雕刻式、压印式等任何切入基板内的标记均按划伤同样对待。

## 2.8.1 Etched Marking (蚀刻标记)

An etched marking is produced the same as the conductors on the printed board. As a result, the following criteria **shall** be met for etched marking:

蚀刻标记的制作和印制板上的导体制作是相同的。因此，蚀刻标记应当符合下列要求。



图281a



图281b

### Target Condition - Class 1,2,3 (目标条件 - 1,2,3级)

- Characters are legible.
- Minimum conductor spacing requirements have also been maintained between etched symbolization and active conductors.
- 每个字符均清晰可辨。
- 蚀刻字符和有源导体之间保持最小导体间距要求。

### Acceptable - Class 3 (可接受条件 - 3级)

- Marking defects regardless of cause, (i.e., solder bridging, over-etching, etc.) as long as characters are legible.
- Marking does not violate the minimum electrical clearance limits.
- Edges of the lines forming a character may be slightly irregular.
- 在字符清晰可辨的情况下，标记缺陷（例如焊料桥连、过度蚀刻等）均可接受。
- 标记不违反最小电气间隙要求。
- 形成字符的线条边缘可以呈现轻微的不规则。

### Acceptable - Class 2 (可接受条件 - 2级)

- Marking defects regardless of cause, (i.e., solder bridging, over-etching, etc.) as long as characters are legible.
- Marking does not violate the minimum electrical clearance limits.
- Width of the lines forming a character may be reduced by up to 50%, providing they remain legible.
- 在字符清晰可辨的情况下，标记缺陷（例如焊料桥连、过度蚀刻等）均可接受。
- 标记不违反最小电气间隙要求。
- 形成字符的线条宽度可减少50%，只要线条仍可辨识。

### 2.8.1 Etched Marking (cont.) (蚀刻标记 (续))



图281c

#### Acceptable - Class 1 (可接受条件 - 1级)

- Marking defects regardless of cause, (i.e., solder bridging, over-etching, etc.) as long as characters are legible.
- Marking does not violate the minimum electrical clearance limits.
- Legends are irregularly formed but the general intent of the legend or marking is legible.
- 在字符清晰可辨的情况下，标记缺陷（例如焊料桥连、过度蚀刻等）均可接受。
- 标记不违反最小电气间隙要求。
- 字符形状不规则，但字符或标记的基本含义尚可辨认。



图281d

#### Nonconforming - Class 1,2,3 (不符合条件 - 1,2,3级)

- Defects either do not meet or exceed above criteria.
- 缺陷不符合或超出上述要求。



## 2.8.2 Screened or Ink Stamped Marking (网印或油墨盖印标记)

Screened or ink stamped marking refers to any type of marking that is printed on top of the printed board. No cutting or etching is involved in producing this type of marking.

网印或油墨盖印标记指印在印制板面上的任何类型的标记。这种类型标记的制作不可含有切入或蚀刻的作法。



图282a



图282b



图282c

### Target Condition - Class 1,2,3 (目标条件 - 1,2,3级)

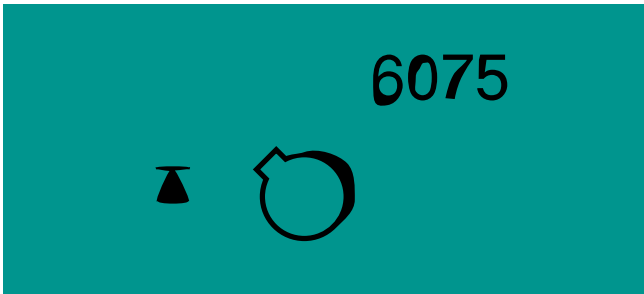
- Characters are legible.
- Ink distribution is uniform, with no smearing or double images.
- Ink markings are no closer than tangent to a land.
- 字符清晰可辨。
- 油墨分布均匀，没有模糊不清或重影。
- 油墨标记至多与焊盘相切。

### Acceptable - Class 2,3 (可接受条件 - 2,3级)

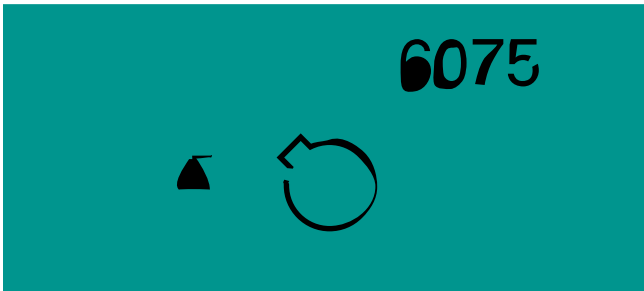
- Characters are legible.
- Ink may be built up outside the character line providing the character is legible.
- Portion of component clocking symbol outline in the Figure 282c example may be missing, providing the required clocking is clearly defined.
- Marking ink on component hole land does not extend into the part mounting hole, or reduce minimum annular ring.
- Marking ink is allowed in PTHs and via holes into which no component lead is soldered unless the procurement document requires that the holes be completely solder filled.
- No encroachment of marking ink on edge board printed contacts or test points.
- On surface mount lands with a pitch of 1.25 mm [0.04921 in] or greater, encroachment of marking ink is on one side of land only and does not exceed 0.05 mm [0.0020 in].
- On surface mount lands with a pitch less than 1.25 mm [0.04921 in], encroachment of marking ink is on one side of land only and does not exceed 0.025 mm [0.000984 in].
- 字符清晰可辨。
- 只要字符可辨，油墨可以堆积在字符线条以外。
- 只要要求的方位仍清楚明确，图282c示例中所图示的元器件方位符号的轮廓可以部分脱落。
- 元器件孔焊盘的标记油墨不得渗入部件安装孔内，或造成环宽低于最小环宽。
- 除非采购文件要求孔被焊料完全填充，不焊接元器件引线的镀覆孔和导通孔内允许有标记油墨。
- 阻焊剂没有侵占到板边印制接触片或测试点表面。
- 对于节距大于等于1.25mm[0.04921in]的表面贴装焊盘，油墨只能侵占焊盘的一侧，且不超过0.05mm[0.0020in]。
- 对于节距小于1.25mm[0.04921in]的表面贴装焊盘，油墨只能侵占焊盘的一侧，且不超过0.025mm[0.000984in]。

## 2.8.2 Screened or Ink Stamped Marking (cont.) (网印或油墨盖印标记 (续))



图282d

**Acceptable - Class 1 (可接受条件 - 1级)**

- Characters are legible.
- Ink may be built up outside the character line providing the character is legible.
- Portion of component clocking symbol outline in the Figure 282c example may be missing, providing the required clocking is clearly defined.
- Marking ink on component hole land does not extend into the part mounting hole, or reduce minimum annular ring.
- Marking ink is allowed in PTHs and via holes into which no component lead is soldered unless the procurement document requires that the holes be completely solder filled.
- No encroachment of marking ink on edge board printed contacts or test points.
- On surface mount lands with a pitch of 1.25 mm [0.04921 in] or greater, encroachment of marking ink is on one side of land only and does not exceed 0.05 mm [0.0020 in].
- On surface mount lands with a pitch less than 1.25 mm [0.04921 in], encroachment of marking ink is on one side of land only and does not exceed 0.025 mm [0.000984 in].
- Marking may be smeared or blurred provided it is still legible.
- Double images are legible.
- 字符清晰可辨。
- 只要字符可辨，油墨可以堆积在字符线条以外。
- 只要要求的方位仍清楚明确，图282c示例中所图示的元器件方位符号的轮廓可以部分脱落。
- 元器件孔焊盘的标记油墨不得渗入部件安装孔内，或造成环宽低于最小环宽。
- 除非采购文件要求孔被焊料完全填充，不焊接元器件引线的镀覆孔和导通孔内允许有标记油墨。
- 阻焊剂没侵占到板边印制接触片或测试点表面。
- 对于节距大于等于1.25mm[0.04921in]的表面贴装焊盘，油墨只能侵占焊盘的一侧，且不超过0.05mm[0.0020in]。
- 对于节距小于1.25mm[0.04921 in]的表面贴装焊盘，油墨只能侵占焊盘的一侧，且不超过0.025mm[0.000984in]。
- 标记被涂污或模糊，但仍可辨认。
- 出现重影，但仍可辨认。

**Nonconforming - Class 1,2,3 (不符合条件 - 1,2,3级)**

- Defects either do not meet or exceed above criteria.
- 缺陷不符合或超出上述要求。

## Introduction (引言)

The term “Solder Mask” is used in this document as a general term when referring to any type of permanent polymer coating material used on printed boards. Solder masks are used to limit and control the application of solder to selected areas of the printed board during assembly soldering operations. Solder mask coatings are used to control and limit surface contamination of printed board surfaces during soldering and subsequent processing operations, and are sometimes used to reduce dendritic filament growth(s) between conductive patterns over the printed board base material surface. Detailed specifications and information regarding solder mask requirements are contained in IPC-6012 and IPC-SM-840.

Solder mask materials are not intended for use as a substitute for conformal coatings that are applied after assembly to cover components, component lead/terminations and solder connections. Determination of compatibility of solder mask materials with conformal coating materials, or other substances, is dependent upon the end item assembly environments.

Solder mask thickness cannot be visually determined. If solder mask thickness is specified, microsectional analysis is required and evaluated per 3.3.12.

The types of solder mask include:

- Deposited image, (liquid) screen printed form.
- Deposited image, electrostatic.
- Photo defined image, (liquid) form.
- Photo defined image, (dry film) form.
- Photo defined image, temporary mask.
- Photo defined, dry film over liquid.

**Note:** Touch up, if required to cover these areas with solder mask, **shall** be of a material that is compatible to and of equal resistance to soldering and cleaning as the originally applied mask.

本文件使用的术语“阻焊膜（阻焊剂）”是指在印制板上用到的任何类型的永久性聚合物涂覆材料的通用术语。在装配焊接操作期间，阻焊膜（阻焊剂）用来在印制板所选定的区域内限制及控制焊料的施加。阻焊涂覆层还用于在焊接中及后续的工艺操作中控制及减少印制板表面的污染，有时还用于减少在印制板基材表面导电图形之间枝状细丝（枝晶）的生长。有关阻焊膜要求的详细规范及信息参见IPC-6012和IPC-SM-840。

阻焊剂材料不能作为装配后覆盖元器件、元器件引线/端子及焊接连接的敷形涂覆层的代用品。阻焊剂材料与敷形涂覆材料或其它材料兼容性的确定取决于最后组件的使用环境。

阻焊膜厚度不能通过目视检查确定。如果阻焊膜厚度有规定，则要求按3.3.12节做显微切片分析和评定。

阻焊剂的类型包括：

- 液态网印成像型；
- 静电沉积成像型；
- 液态光致成像型阻焊剂；
- 干膜光致成像型阻焊剂；
- 光致成像型暂性阻焊剂；
- 干膜覆盖在湿膜上的光致成像型阻焊剂。

**注：**如要求用阻焊膜修补以覆盖这些区域时，**应当**使用与最初使用的阻焊剂相兼容的并具有同等耐焊接性和耐清洗性的材料。

## 2.9.1 Coverage Over Conductors (Skip Coverage) (导体上的覆盖 (跳印))



图291a



图291b

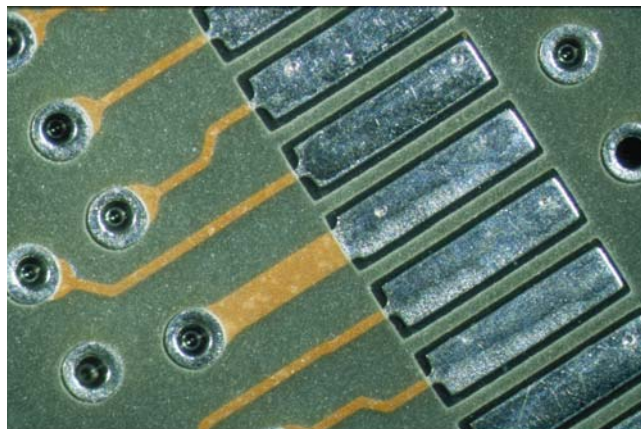

图291c

**Target Condition - Class 1,2,3 (目标条件 - 1,2,3级)**

- The solder mask exhibits uniform appearance over the base material surface, conductor sides and edges. It is firmly bonded to the printed board surface with no visible skipping, voids or other defects.
- 阻焊膜在基材表面、导体侧面和边缘处都呈现均匀的外表，并已牢固粘接在印制板表面上，无可见的跳印、空洞或其它缺陷。

**Acceptable - Class 2,3 (可接受条件 - 2,3级)**

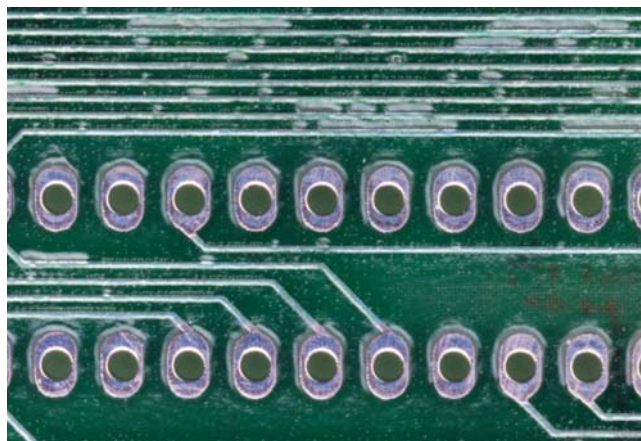
- In areas containing parallel conductors, adjacent conductors are not exposed by the absence of solder mask except where space between conductors is intended to be exposed.
- Touch up, if required to cover these areas with solder mask, is of a material that is compatible to and of equal resistance to soldering and cleaning as the originally applied solder mask.
- 在有平行导体的区域内，除了导体之间有意不覆盖阻焊剂处外，没有由于缺少阻焊剂而使相邻导体暴露。
- 如要求用阻焊膜修补以覆盖这些区域时，使用与最初使用的阻焊剂相兼容的并具有同等耐焊接性和耐清洗性的材料。

**Acceptable - Class 1 (可接受条件 - 1级)**

- The missing solder mask does not reduce the conductor spacing between conductive patterns below the minimum acceptability requirements.
- There is skipping of the solder mask along the sides of the conductive patterns.
- 缺失的阻焊膜未使导体间的间距减少至低于最小可接收性要求。
- 沿着导电图形侧边可有跳印的阻焊膜。

**Nonconforming - Class 1,2,3 (不符合条件 - 1,2,3级)**

- Defects either do not meet or exceed above criteria.
- 缺陷不符合或超出上述要求。



2.9.2 Registration to Holes (All Finishes) (与孔的重合度 (所有涂覆层))



图292a



图292b

**Target Condition - Class 1,2,3**  
(目标条件 - 1,2,3级)

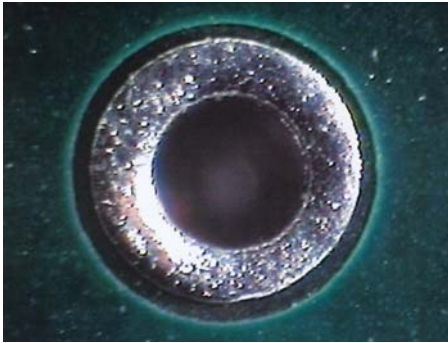
- No solder mask misregistration. The solder mask is centered around the lands within the nominal registration spacings.
- 未出现阻焊膜错位。阻焊膜在标称的重合度间距内，以焊盘为中心环绕在其周围。

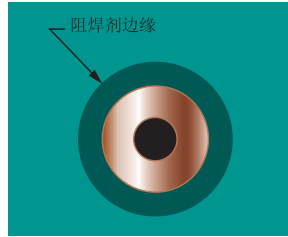

图292c



图292d

**Acceptable - Class 1,2,3**  
(可接受条件 - 1,2,3级)

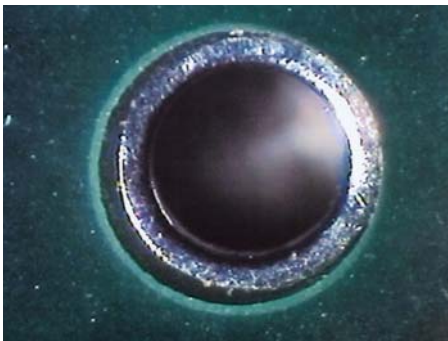
- Misregistration of the mask to the land patterns but the solder mask does not violate minimum annular ring requirements.
- No solder mask in PTHs, except those not intended for soldering.
- Adjacent, electrically isolated lands or conductors are not exposed.
- 阻焊膜图形与焊盘错位，但不违反最小环宽要求。
- 除那些无需焊接的孔外，镀覆孔内无阻焊膜。
- 未暴露相互电气隔离的相邻焊盘或导体。

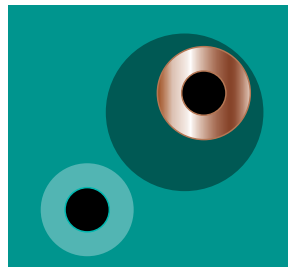

图292e



图292f

**Nonconforming - Class 1,2,3**  
(不符合条件 - 1,2,3级)

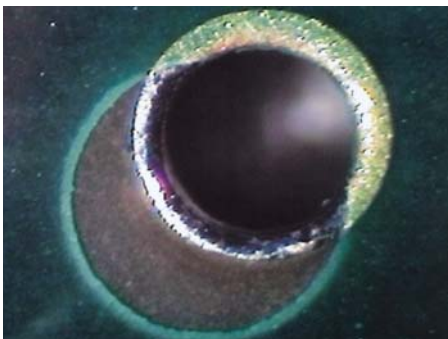
- Defects either do not meet or exceed above criteria.
- 缺陷不符合或超出上述要求。

## 2.9.3 Registration to Other Conductive Patterns (与其它导电图形的重合度)

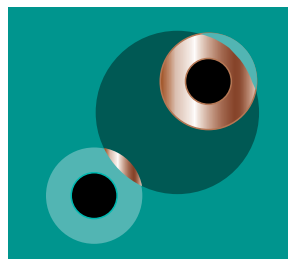

图293a

**Target Condition - Class 1,2,3 (目标条件 - 1,2,3级)**

- No solder mask misregistration.
- 未出现阻焊膜错位。

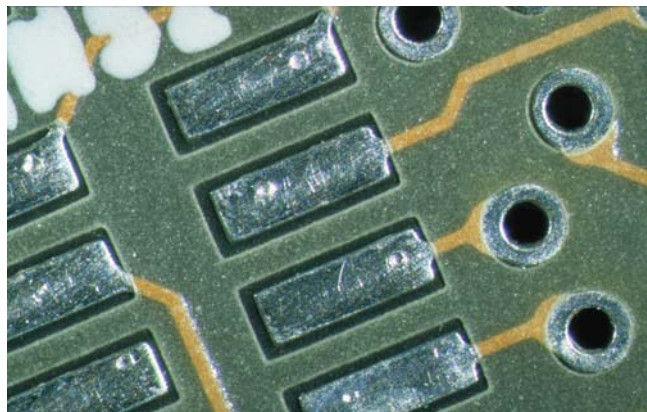

图293b

**Acceptable - Class 1,2,3 (可接受条件 - 1,2,3级)**

- Misregistration to copper-defined lands does not expose adjacent, electrically isolated lands or conductors.
- No solder mask encroachment on edge board printed contacts or test points.
- On surface mount lands with a pitch of 1.25 mm [0.04921 in] or greater, encroachment is on one side of land only and does not exceed 0.05 mm [0.0020 in].
- On surface mount lands with a pitch less than 1.25 mm [0.04921 in], encroachment is on one side of land only and does not exceed 0.025 mm [0.000984 in].
- 阻焊膜与铜箔限定的焊盘之间的错位没有暴露相邻的电气隔离的焊盘或导体。
- 阻焊膜没有侵占板边印制接触片或测试点。
- 对于节距大于或等于1.25mm[0.04921in]的表面贴装焊盘，只能侵占焊盘的一侧，且不超过0.05mm[0.0020in]。
- 对于节距小于1.25mm[0.04921in]的表面贴装焊盘，只能侵占焊盘的一侧，且不超过0.025mm[0.000984in]。

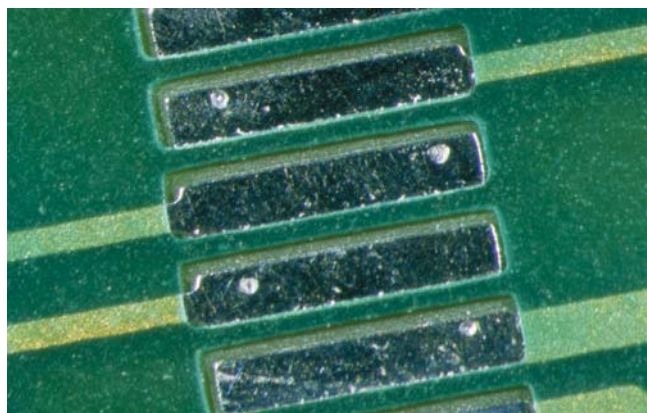

图293c

**Nonconforming - Class 1,2,3 (不符合条件 - 1,2,3级)**

- Defects either do not meet or exceed above criteria.
- 缺陷不符合或超出上述要求。

### 2.9.3.1 Ball Grid Array (Solder Mask-Defined Lands) (球栅列阵 (阻焊膜限定的焊盘))

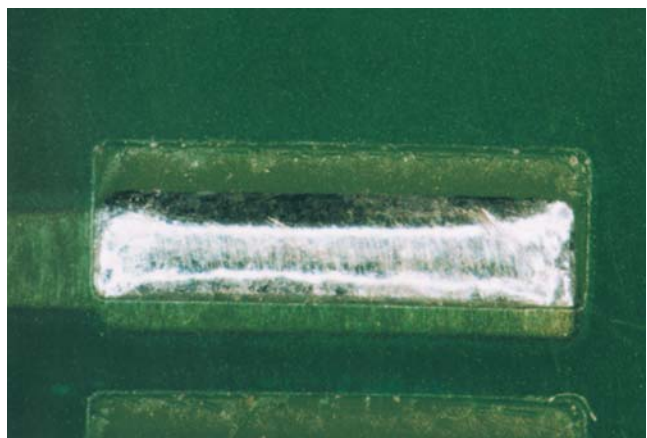
**Solder Mask-Defined Lands:** A portion of the conductive pattern, used to connect electronic component ball terminations, (BGAs, Fine-Pitch BGAs, etc.), where the solder mask encroaches on the edges of the land to restrict the ball attachment within the solder mask profile.

**阻焊膜限定的焊盘:** 导电图形的一部分，用来连接电子元器件的球形端子（BGA、细节距BGA等），阻焊膜侵占到焊盘的边缘，从而将球形连接限制在阻焊膜围绕的范围内。



图2931a

#### Target Condition - Class 1,2,3 (目标条件 - 1,2,3级)

- The solder mask overlap is centered around the lands.
- 阻焊膜与焊盘的重叠区以焊盘为中心，环绕在其周围。

#### Acceptable - Class 1,2,3 (可接受条件 - 1,2,3级)

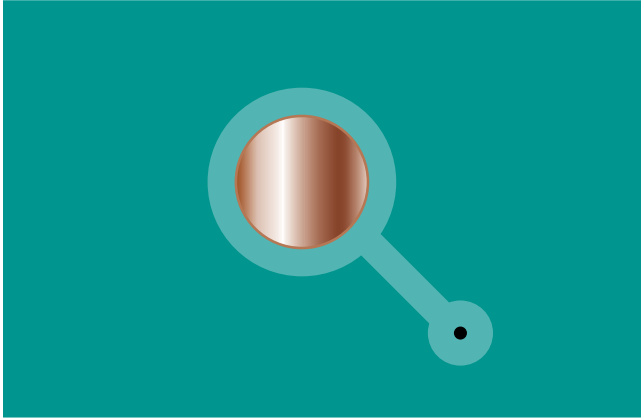
- Misregistration creates breakout of the solder mask on the land of not more than 90°.
- 错位使阻焊膜在焊盘上的破出区域不超过90°。

#### Nonconforming - Class 1,2,3 (不符合条件 - 1,2,3级)

- Defects either do not meet or exceed above criteria.
- 缺陷不符合或超出上述要求。

### 2.9.3.2 Ball Grid Array (Copper-Defined Lands) (球栅列阵 (铜箔限定的焊盘))

**Copper-Defined Lands:** A portion of the conductive pattern usually, but not exclusively, used for the connection and/or attachment of components where the land metal is involved in the attachment process, and if solder mask is applied to the product a clearance is provided for the land area.

**铜箔限定的焊盘:** 通常 (但并非一定) 为导电图形的一部分, 在焊接过程中, 焊盘金属用来连接和/或焊接元器件, 如果产品涂覆阻焊膜, 则焊盘区周围留有间隙。



图2932a

#### Target Condition - Class 1,2,3 (目标条件 - 1,2,3级)

- The solder mask is centered around the copper land with clearance.
- 阻焊膜以铜焊盘为中心, 环绕其周围并留有间隙。

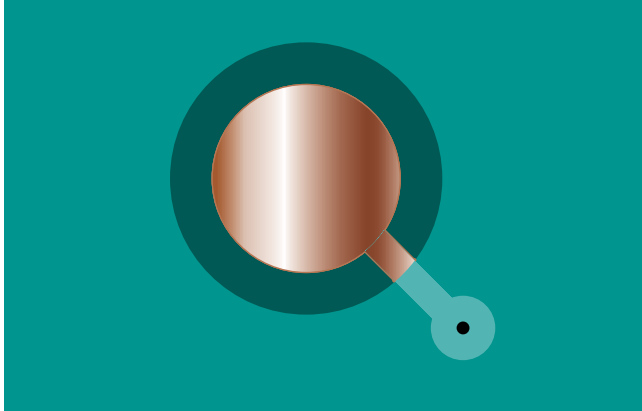

图2932b

#### Acceptable - Class 1,2,3 (可接受条件 - 1,2,3级)

- Solder mask does not encroach on the land, except at the conductor attachment.
- 除了导体连接处外, 阻焊膜未涂覆侵占到焊盘上。

#### Nonconforming - Class 1,2,3 (不符合条件 - 1,2,3级)

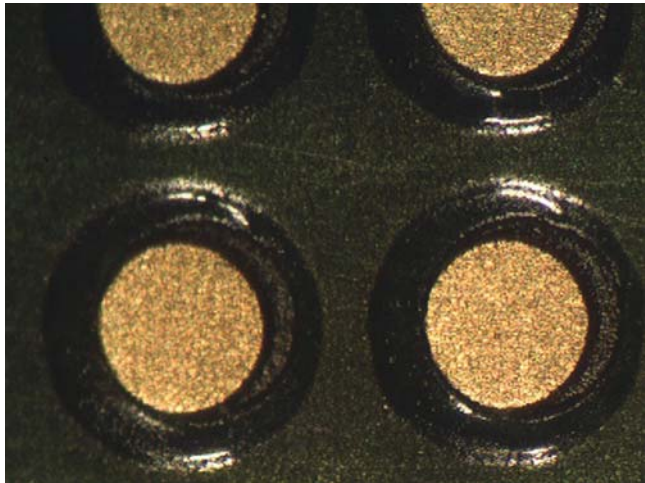
- Defects either do not meet or exceed above criteria.
- 缺陷不符合或超出上述要求。



### 2.9.3.3 Ball Grid Array (Solder Dam) (球栅列阵 (阻焊坝))

**Solder Dam:** A portion of the solder mask pattern, used in conjunction with BGA or Fine Pitch BGA mounting, that provides a segment of solder mask material to separate the mounting portion of the pattern and the interconnection via in order to avoid solder being skived from the attachment joint into the via.

**阻焊坝:** 阻焊图形的一部分, 用于BGA或细节距BGA贴装连接, 以一小段阻焊材料将图形的贴装部分与互连导通孔隔开, 以避免焊料从焊接处落入导通孔内。



图2933a

#### Target Condition - Class 1,2,3 (目标条件 - 1,2,3级)

- The solder mask is centered around the copper land and escape via with clearance. Mask only covers the conductor between copper land and escape via.
- 阻焊膜分别以铜焊盘和导通孔为中心, 并留有余隙。阻焊膜仅覆盖铜焊盘与导通孔间的导体。

#### Acceptable - Class 1,2,3 (可接受条件 - 1,2,3级)

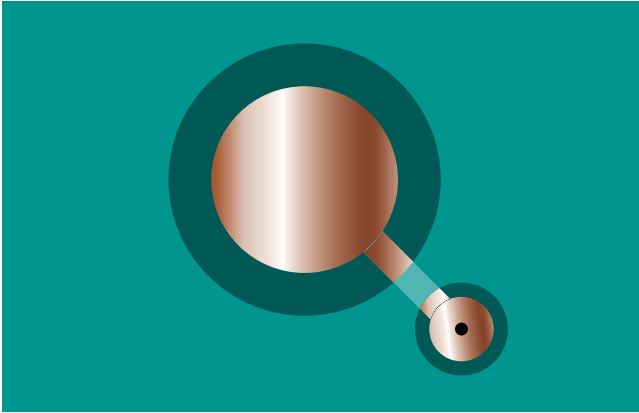
- If solder mask dam is specified (to prevent bridging of solder to the via), it remains in place with the copper covered.
- 若规定有阻焊坝 (为防止焊料与导通孔的桥连), 阻焊坝保留在规规定位置, 且铜被覆盖。

#### Nonconforming - Class 1,2,3 (不符合条件 - 1,2,3级)

- Defects either do not meet or exceed above criteria.
- 缺陷不符合或超出上述要求。

### 2.9.4 Blisters/Delamination (起泡/分层)



图294a

#### Target Condition - Class 1,2,3 (目标条件 - 1,2,3级)

- No evidence of blisters, bubbles or delamination between the solder mask and the printed board base material and conductive patterns.
- 阻焊膜和印制板基材及导电图形之间无起泡、气泡或分层迹象。

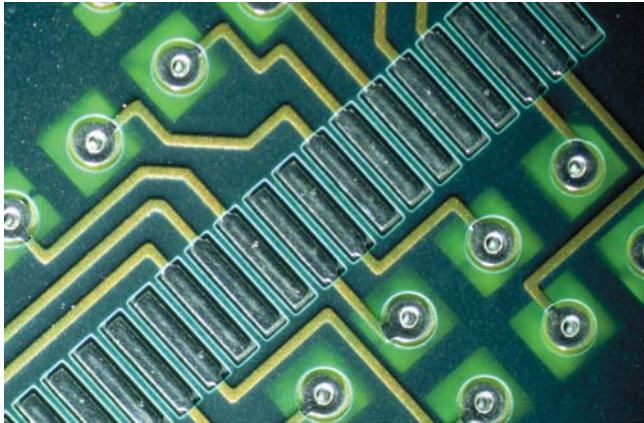

图294b

#### Acceptable - Class 2,3 (可接受条件 - 2,3级)

- Two per side not exceeding 0.25 mm [0.00984 in] in the greatest dimension.
- Reduction of electrical spacing does not exceed 25%, or the minimum spacing.
- 印制板每面可有两个瑕疵，每个瑕疵的最大尺寸不超过0.25 mm[0.00984 in]。
- 电气间距的减少量不超过间距的25%，或减少后的电气间距不小于最小间距。

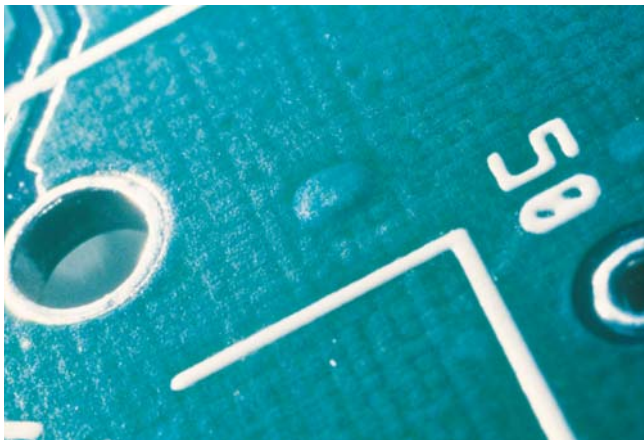

图294c

#### Acceptable - Class 1 (可接受条件 - 1级)

- Blisters, bubbles or delamination do not bridge between conductors.
- 起泡、气泡或分层没有使导体桥连。

### 2.9.4 Blisters/Delamination (cont.) (起泡/分层 (续))

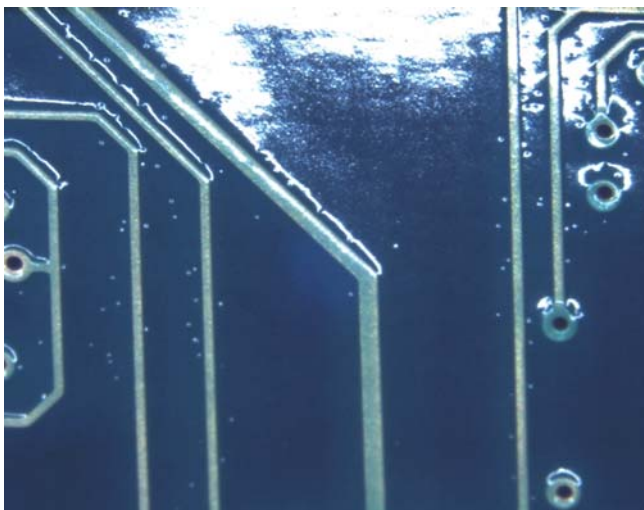

图294d

#### Nonconforming - Class 1,2,3 (不符合条件 - 1,2,3级)

- Defects either do not meet or exceed above criteria.
- 缺陷不符合或超出上述要求。

## 2.9.5 Adhesion (Flaking or Peeling) (附着力 (剥落或起皮))

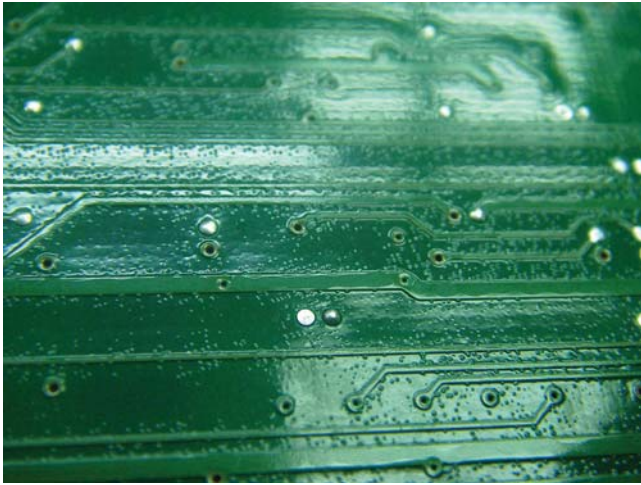

图295a

**Target Condition - Class 1,2,3 (目标条件 - 1,2,3级)**

- The surface of the solder mask is uniform in appearance and is firmly bonded to the printed board surfaces.
- 阻焊膜表面外观均匀并牢固地粘附在印制板表面。

**Acceptable - Class 2,3 (可接受条件 - 2,3级)**

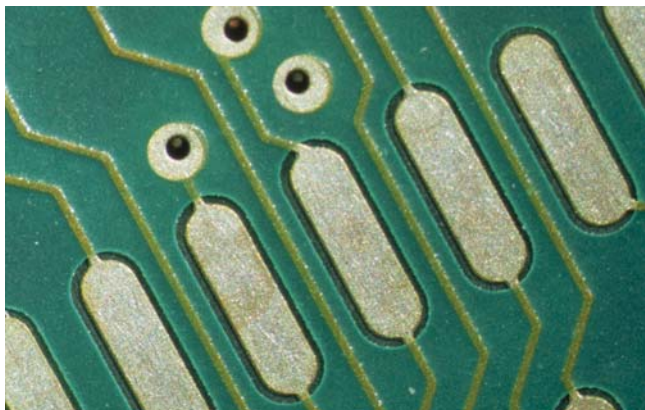
- No evidence of solder mask lifting from the printed board prior to testing.
- After testing in accordance with IPC-TM-650, Method 2.4.28.1, the amount of solder mask lifting does not exceed the allowable limits of the IPC-6010 Series.
- 测试前没有阻焊膜从板面上起翘的迹象。
- 按照IPC-TM-650测试方法2.4.28.1测试后，阻焊膜的脱落量未超过IPC-6010系列标准规定的允许限值。



图295b

**Acceptable - Class 1 (可接受条件 - 1级)**

- Prior to testing, the solder mask is flaking from the printed board base material or conductive pattern surfaces and the remaining solder mask is firmly bonded. The missing solder mask does not expose adjacent conductive patterns or exceed allowable lifting.
- After testing in accordance with IPC-TM-650, Method 2.4.28.1, the amount of solder mask lifting does not exceed the allowable limits of the IPC-6010 Series.
- 测试前有阻焊膜从印制板基材或导电图形表面剥落，但其余阻焊膜牢固地粘附在板面上。缺失的阻焊膜未暴露相邻导电图形或未超过脱落的允许值。
- 按照IPC-TM-650测试方法2.4.28.1测试后，阻焊膜脱落量未超过IPC-6010系列标准的允许限值。

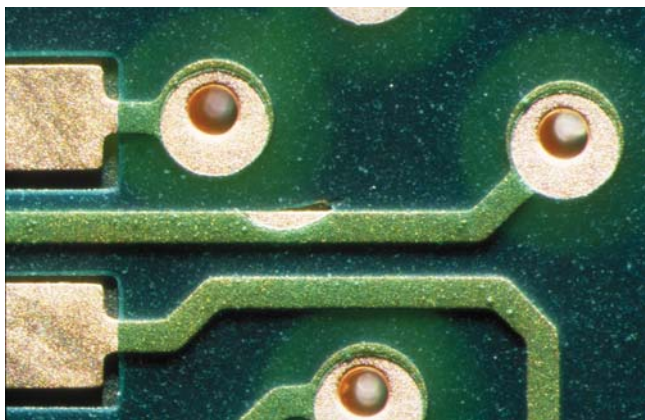

图295c

**Nonconforming - Class 1,2,3 (不符合条件 - 1,2,3级)**

- Defects either do not meet or exceed above criteria.
- 缺陷不符合或超出上述要求。

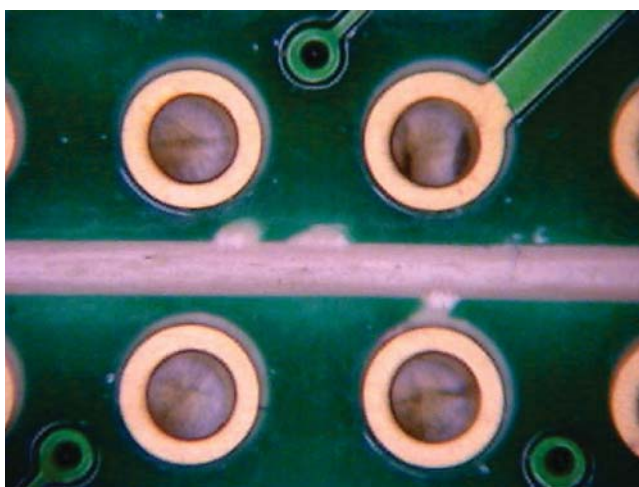

## 2.9.6 Waves/Wrinkles/Ripples (波纹/褶皱/皱纹)



图296a



图296b

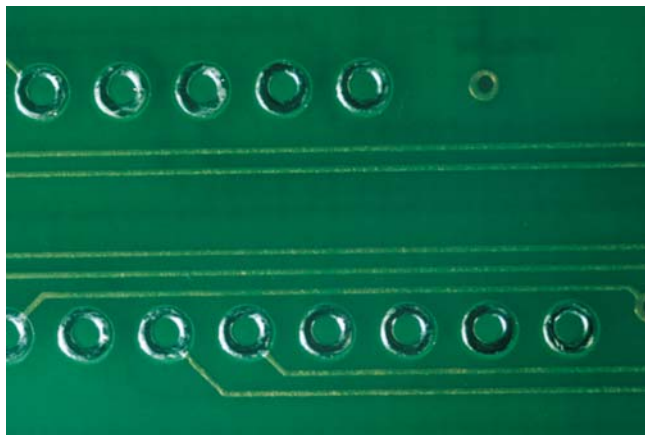

图296c

**Target Condition - Class 1,2,3 (目标条件 - 1,2,3级)**

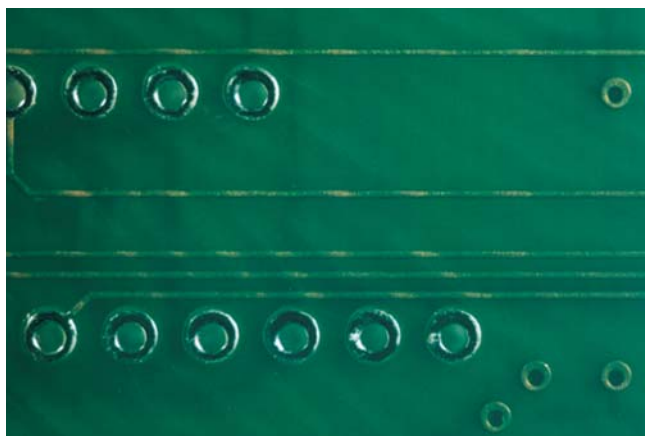
- There are no wrinkles, waves, ripples or other defects in the solder mask coating over the printed board base material surfaces or conductive patterns.
- 印制板基材表面或导电图形上的阻焊膜涂覆层均未出现褶皱、波纹、皱纹或其它缺陷。

**Acceptable - Class 1,2,3 (可接受条件 - 1,2,3级)**

- Waves or ripples in the solder mask do not reduce the solder mask coating thickness below the minimum thickness requirements (when specified).
- Wrinkling is located in an area that does not bridge conductive patterns and passes IPC-TM-640, Method 2.4.28.1 (adhesion tape pull test).
- 阻焊膜中的波纹或皱纹没有使阻焊剂涂覆层厚度减小至低于最小厚度要求 (当有规定时)。
- 在一个区域内出现的皱褶没有使导电图形桥连, 并通过IPC-TM-650测试方法2.4.28.1的胶带附着力测试。

**Nonconforming - Class 1,2,3 (不符合条件 - 1,2,3级)**

- Defects either do not meet or exceed above criteria.
- 缺陷不符合或超出上述要求。



## 2.9.7 Tenting (Via Holes) (掩蔽 (导通孔))

Tenting refers to a via with a mask material applied bridging over the via wherein no additional materials are in the hole. It may be applied to one side or both sides of the via structure (see Figure 297a), though single sided tenting is not recommended.

用掩膜材料涂敷在孔上，而孔内无其它额外材料的导通孔。可从导通孔的任一面或两面涂敷材料（见图297c），但不推荐从单面掩蔽导通孔。



图297a

注：此图仅用作说明状况，并不要求做显微剖切评价。

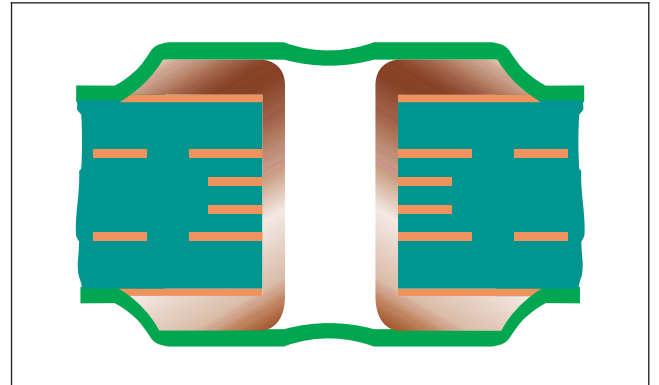

图297b

### Target Condition - Class 1,2,3 (目标条件 - 1,2,3级)

- All holes required to be tented are completely covered with mask.
- 所有要求掩蔽的孔都被掩膜完全覆盖。

### Acceptable - Class 1,2,3 (可接受条件 - 1,2,3级)

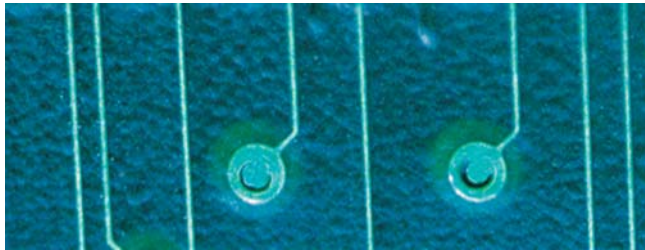
- All holes required to be tented are covered by mask.
- 所有要求掩蔽的孔都被掩膜覆盖。



图297c

### Nonconforming - Class 1,2,3 (不符合条件 - 1,2,3级)

- Defects either do not meet or exceed above criteria.
- 缺陷不符合或超出上述要求。

## 2.9.8 Soda Strawing (吸管状空隙)

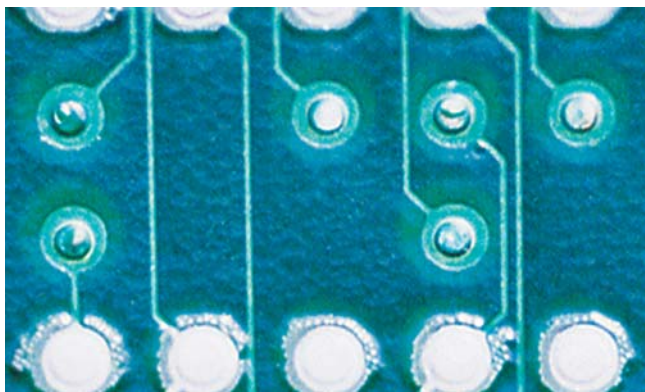
**Soda Strawing:** A long tubular-like void along the edges of conductive patterns where the solder mask is not bonded to the base material surface or the edge of the conductor. Tin/lead fusing fluxes, fusing oils, solder fluxes, cleaning agents or volatile materials may be trapped in the soda straw void.

**吸管状空隙:** 沿着导电图形边缘的一种细长管状的空隙，即阻焊膜未与基材表面或导体边缘粘结。锡铅热熔助焊剂、热熔油、焊接助焊剂、清洗剂或挥发物可能会被夹封在这种吸管状空隙中。



图298a

**Target Condition - Class 1,2,3 (目标条件 - 1,2,3级)**

- No visible soda straw voids between the solder mask and the printed board base material surface and the edges of the conductive patterns.
- 阻焊膜和印制板基材表面以及导电图形的侧边之间均不存在可见空隙。

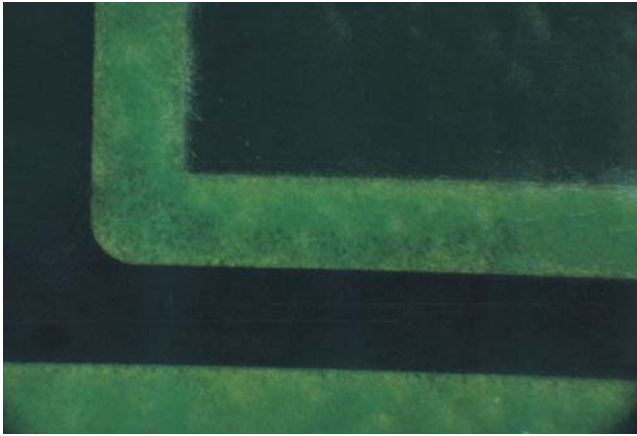

图298b

**Acceptable - Class 3 (可接受条件 - 3级)**

- No evidence of soda strawing.
- 无吸管装空隙迹象。

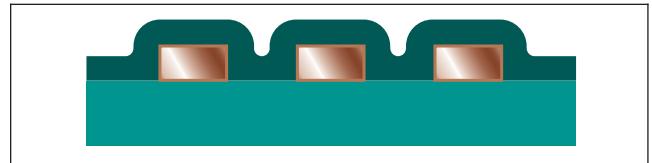

图298c

**Acceptable - Class 1,2 (可接受条件 - 1,2级)**

- Soda strawing along side conductive pattern edges does not reduce the conductor spacing below the minimum requirements.
- Soda strawing is completely sealed from the external environment.
- 沿着导电图形侧面边缘出现吸管状空隙，但未使导体间距减小至低于最小要求。
- 吸管状空隙与周围环境完全封闭。

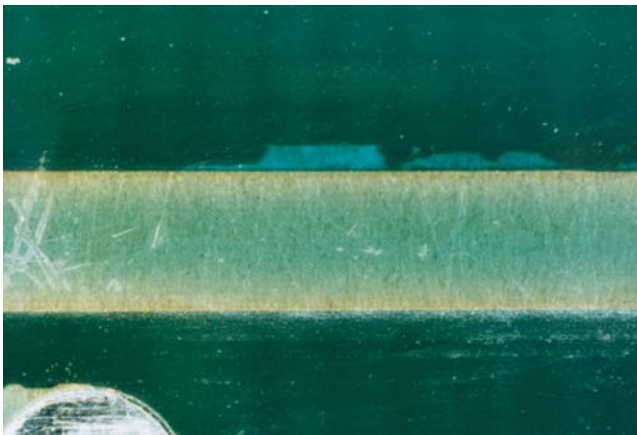

图298d

## 2.9.8 Soda Strawing (cont.) (吸管状空隙 (续))

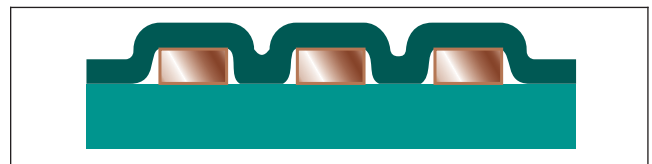

图298e

### Nonconforming - Class 1,2,3 (不符合条件 - 1,2,3级)

- Defects either do not meet or exceed above criteria.
- 缺陷不符合或超出上述要求。

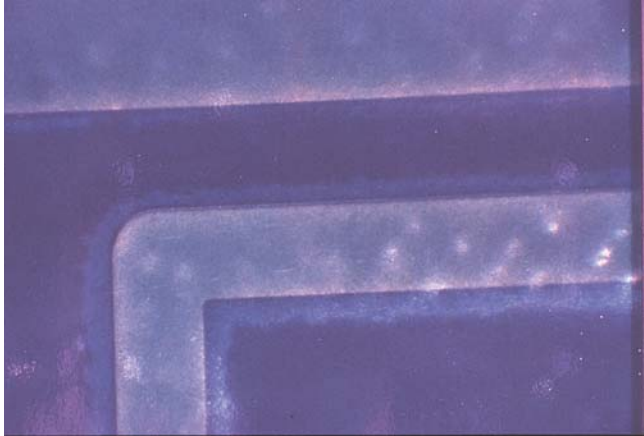

图298f

### Introduction (引言)

Printed boards **shall** meet the dimensional requirements specified on the procurement documentation such as printed board periphery, thickness, cutouts, slots, notches and printed board edge contacts. The accuracy, repeatability and reproducibility of the equipment used to verify the characteristics of printed boards should be 10% or less of the tolerance range of the dimensions being verified.

印制板应当满足采购文件规定的尺寸要求，如板的周边、厚度、切口、开槽、缺口及印制板边接触片等。用于验证印制板这些特性的设备的精度、可重复性及可再现性应该为所验证尺寸公差范围的10%或更小。

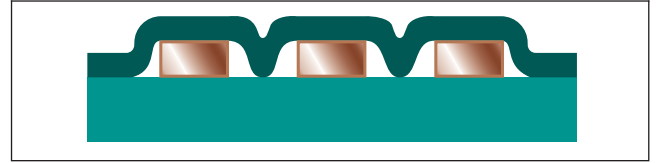
#### 2.10.1 Conductor Width and Spacing (导体宽度和间距)

This section covers acceptability requirements and criteria for conductor width and spacing. Acceptable conductor width and spacing is a measure of how well the printed board fabrication process is reproducing the master image, which basically determines the width and spacing requirements for the conductive patterns. Unless these characteristics are violated, edge definition itself is not necessarily a characteristic for acceptance or nonconformance; however, it can be considered a process indicator, requiring review of manufacturing procedures. In addition it may be an important consideration for controlled impedance circuits. Procurement documentation should establish edge definition requirements for applications of these types. When required, measurements of conductor edge definition are made in accordance with IPC-TM-650, Method 2.2.2.

本节包括导体宽度和间距的可接受性要求及准则。导体宽度和间距的可接受性是印制板制造工艺复现原始底片好坏的一种度量，原始底片已基本确定了导电图形的最小宽度和间距要求。除非违反了这些特征，导体边缘的精确度不必作为验收或拒收的特性，但却可作为一种制程警示，要求对生产工艺作出审核。此外，对控制阻抗电路，可能是一项需要考虑的重要因素。此类用途的印制板应该在采购文件中规定边缘精确度要求。有要求时，按IPC-TM-650测试方法2.2.2测量导体边缘精确度。



### 2.10.1.1 Conductor Width (导体宽度)



图21011a



图21011b

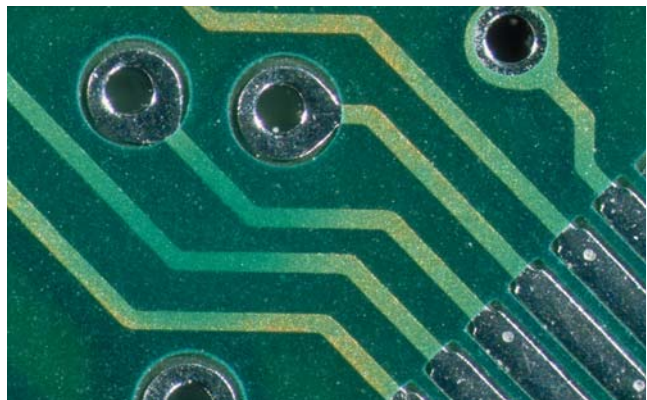

图21011c

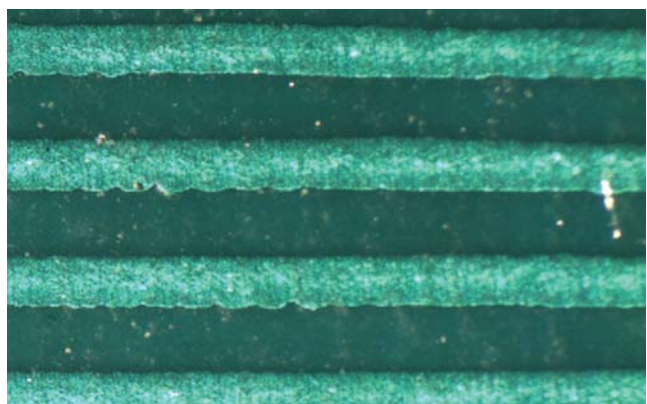

图21011d

#### Target Condition - Class 1,2,3 (目标条件 - 1,2,3级)

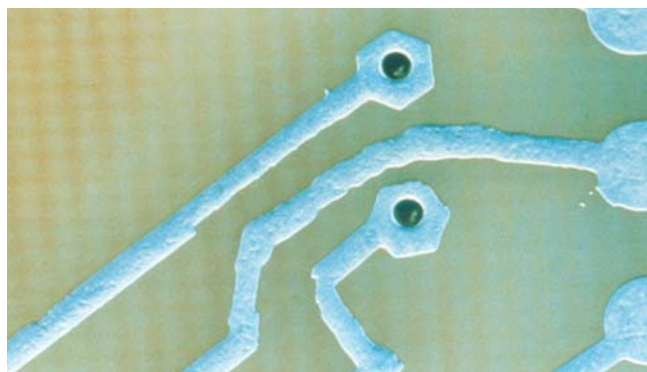
- Conductor width meets dimensional requirements of artwork or procurement documentation.
- 导体宽度及间距满足照相制版或采购文件的尺寸要求。

#### Acceptable - Class 2,3 (可接受条件 - 2,3级)

- Any combination of isolated edge roughness, nicks, pinholes, and scratches exposing base material that reduces the conductor width by 20% of the minimum value or less.
- There is no occurrence (edge roughness, nicks, etc.) greater than 10% of the conductor length or more than 13.0 mm [0.512 in], whichever is less.
- 孤立的导体边缘粗糙、缺口、针孔及暴露基材的划伤等缺陷的任何组合使导体宽度的减小量小于等于最小宽度的20%。
- 缺陷（边缘粗糙、缺口等）总长度不大于导体长度的10%，或不超过13mm[0.512in]，取两者中的较小者。

#### Acceptable - Class 1 (可接受条件 - 1级)

- Any combination of isolated edge roughness, nicks, pinholes, and scratches exposing base material that reduces the conductor width 30% of the minimum value or less.
- There is no occurrence (edge roughness, nicks, etc.) greater than 10% of the conductor length or more than 25.0 mm [0.984 in], whichever is less.
- 孤立的导体边缘粗糙、缺口、针孔及暴露基材的划伤等缺陷的任何组合使导体宽度的减小量小于等于最小宽度的30%。
- 缺陷（边缘粗糙、缺口等）总长度不大于导体长度的10%，或不超过25mm[0.984in]，取两者中的取较小者。

#### Nonconforming - Class 1,2,3 (不符合条件 - 1,2,3级)

- Defects either do not meet or exceed above criteria.
- 缺陷不符合或超出上述要求。

### 2.10.1.2 Conductor Spacing (导体间距)



图21012a



图21012b

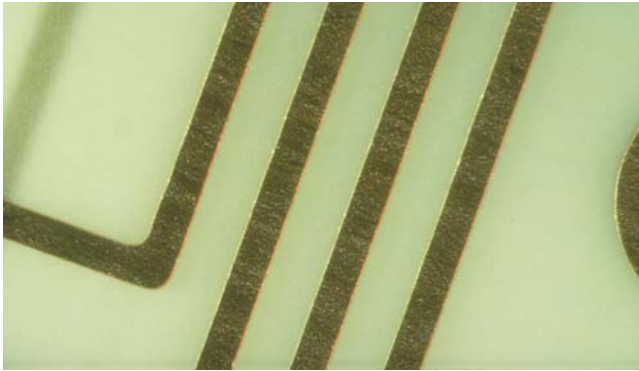

图21012c

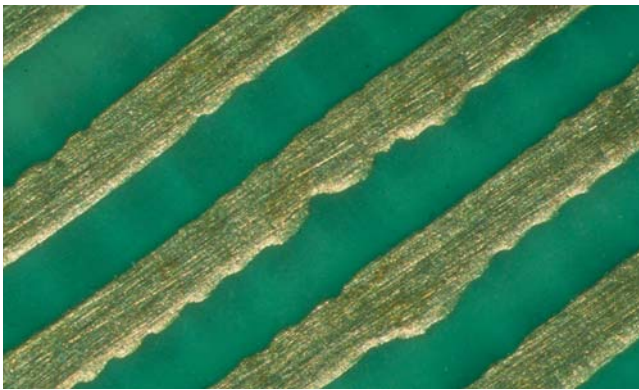

图21012d

#### Target Condition - Class 1,2,3 (目标条件 - 1,2,3级)

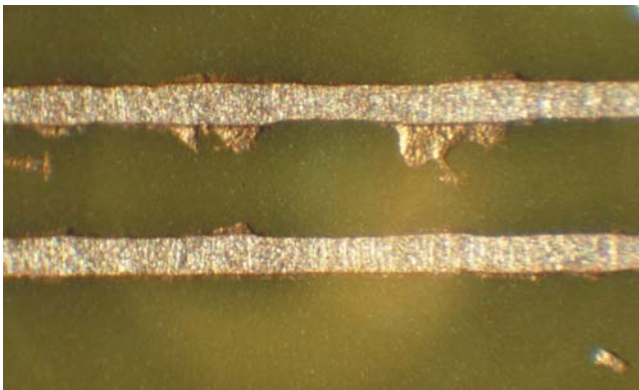
- Conductor spacing meets dimensional requirements of the procurement documentation.
- 导体间距满足采购文件的尺寸要求。

#### Acceptable - Class 3 (可接受条件 - 3级)

- Any combination of edge roughness, copper spikes, etc., that does not reduce the specified minimum conductor spacing by more than 20% in isolated areas.
- 任何孤立区域内导体边缘粗糙、铜刺等缺陷的任意组合未使规定的最小导体间距的减少大于20%。

#### Acceptable - Class 1,2 (可接受条件 - 1,2级)

- Any combination of edge roughness, copper spikes, etc., that does not reduce the specified minimum conductor spacing by more than 30% in isolated areas.
- 任何孤立区域内导体边缘粗糙、铜刺等缺陷的任意组合未使规定的最小导体间距的减少大于30%。

#### Nonconforming - Class 1,2,3 (不符合条件 - 1,2,3级)

- Defects either do not meet or exceed above criteria.
- 缺陷不符合或超出上述要求。

## 2.10.2 External Annular Ring – Measurement (外层环宽的测量)

**External Annular Ring:** The minimum annular ring on external layers is the minimum amount of copper (at the narrowest point) between the edge of the hole and the edge of the land after plating of the finished hole (see Figure 2102a). Hole breakout refers to a condition where a hole is not completely surrounded by the land (see Figure 2102b).

**外层环宽:** 外层的最小环宽是成品孔在电镀后孔边缘和焊盘边缘之间（最窄处）的最小量的铜（见图2102a）。孔的破坏指孔未被焊盘完全包围的状况（见图2101b）。



图2102a 外层环宽



图2102b 90° 和180° 的破坏

**Conductor to Land Junction:** A 90° area centered around the point where the conductor connects to the land (see Figure 2102c). This area only applies to breakout conditions (see Figure 2102d).

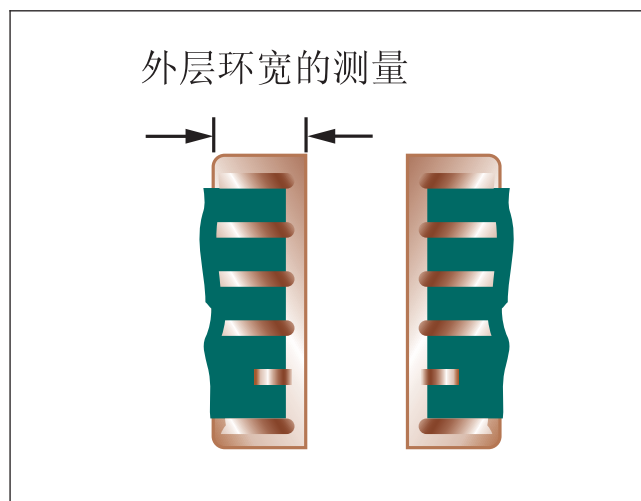
**导体与焊盘的连接区:** 以导体与焊盘连接点为中心的90° 区域（见图2102c）。该区域仅适用于破坏的状况（见图2102d）。

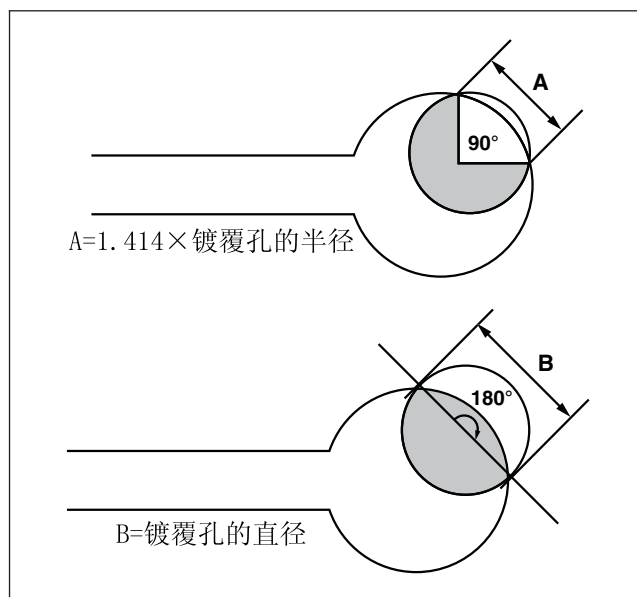

图2102c 导体与焊盘的连接区



图2102d 导体与焊盘连接处的破坏

### 2.10.3 External Annular Ring – Supported Holes (支撑孔的外层环宽)

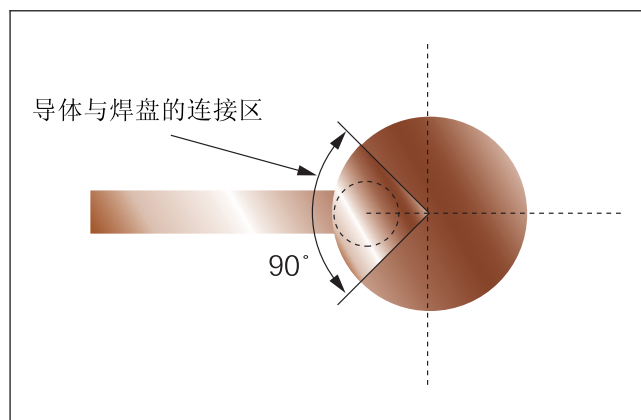
**Supported Hole:** A hole within a printed board that has its inside surfaces plated or otherwise reinforced.

**支撑孔:** 印制板中孔的表面经过电镀或采用其它方法增强的孔。

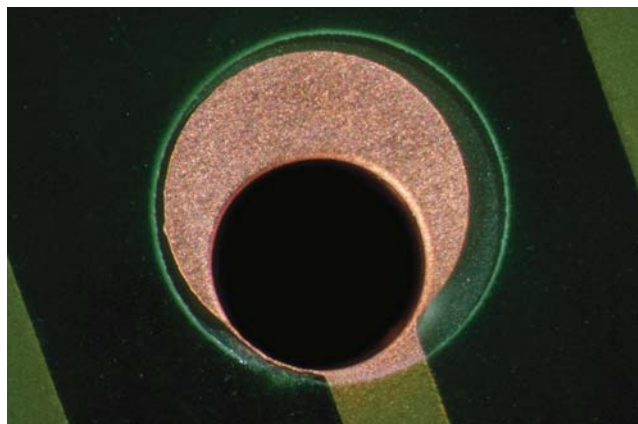

图2103a

**Target Condition - Class 1,2,3 (目标条件 - 1,2,3级)**

- Holes are centered in the lands.
- 孔位于焊盘中心。

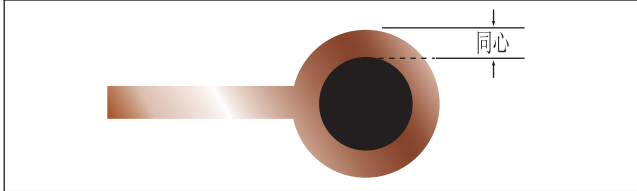

图2103b

**Acceptable - Class 3 (可接受条件 - 3级)**

- Holes are not centered in the lands, but the annular ring measures 0.050 mm [0.0020 in] or more.
- The minimum external annular ring may have 20% reduction of the minimum annular at the measurement area due to defects such as pits, dents, nicks, pinholes, or splay.
- 孔没有位于焊盘中心, 但环宽大于或等于0.050mm[0.0020 in]。
- 测量区域内的最小环宽由于诸如麻点、凹坑、缺口、针孔或斜孔等缺陷的存在, 可减少最小外层环宽的20%。

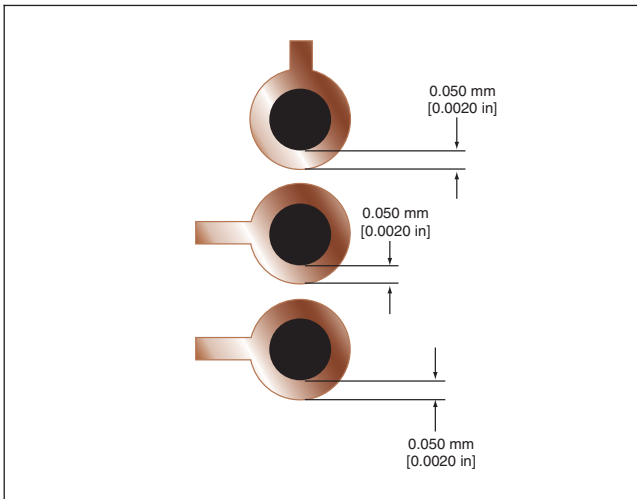

图2103c



## 2.10.3 External Annular Ring – Supported Holes (cont.) (支撑孔的外层环宽 (续))

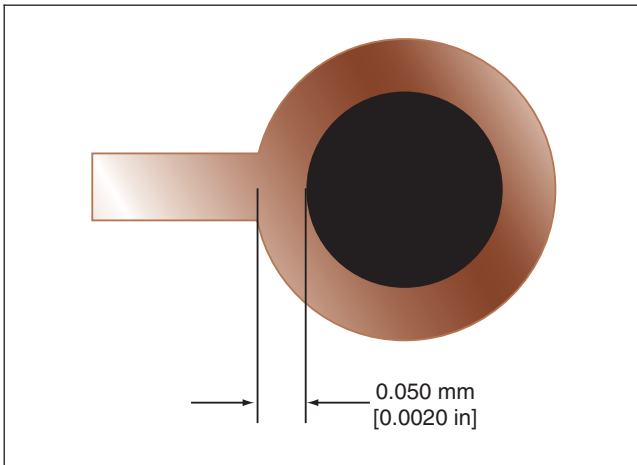

图2103d

**Acceptable - Class 2 (可接受条件 - 2级)**

- 90° breakout or less (see item A in Figure 2103d).
- If breakout occurs at the conductor to land junction area, the land/conductor junction is not reduced by more than 20% of the minimum conductor width specified on the engineering drawing or the production master nominal. The conductor junction should never be less than 0.050 mm [0.0020 in] or the minimum line width, whichever is smaller (see item C in Figure 2103d).
- Minimum lateral spacing is maintained.
- 破坏小于或等于90° (见图2103d中的A项)。
- 如破坏发生在焊盘与导体的连接区, 则导体宽度的减少不大于工程图纸或生产底版中标称的最小导体宽度的20%。导体连接处绝不应该小于0.050mm[0.0020in], 或不应该小于最小线宽, 取两者中的较小者 (见图2103d中的C项)。
- 满足导体之间最小侧向间距要求。

**Acceptable - Class 1 (可接受条件 - 1级)**

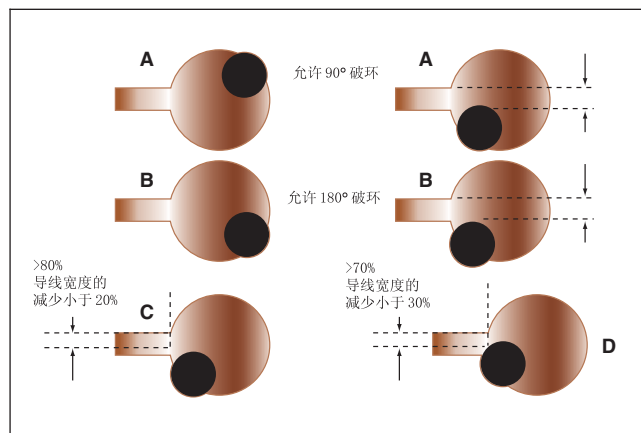
- 180° breakout or less (see item B in Figure 2103d).
- If breakout occurs at the conductor to land junction area, the conductor is not reduced by more than 30% of the minimum conductor width specified on the production master nominal (see item D in Figure 2103d).
- Form, fit and function are not affected.
- Minimum lateral spacing is maintained.
- 破坏小于或等于180° (见图2103d中的B项)。
- 如破坏发生在焊盘与导体的连接区, 导体宽度的减少不大于生产底版中标称的最小导体宽度的30%。(见图2103d中的D项)
- 外形、安装和功能未受影响。
- 满足导体之间最小侧向间距要求。

**Nonconforming - Class 1,2,3 (不符合条件 - 1,2,3级)**

- Defects either do not meet or exceed above criteria.
- 缺陷不符合或超出上述要求。

## 2.10.4 External Annular Ring – Unsupported Holes (非支撑孔的外层环宽)

**Unsupported Hole:** A hole within a printed board that does not contain plating or other type of conductive reinforcement.

**非支撑孔:** 印制板中不包含镀层或其它类型导电增强材料的孔。



图2104a



图2104b

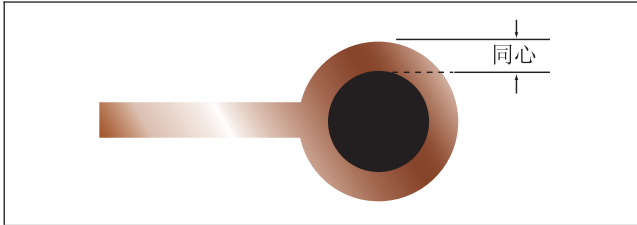

图2104c

**Target Condition - Class 1,2,3 (目标条件 - 1,2,3级)**

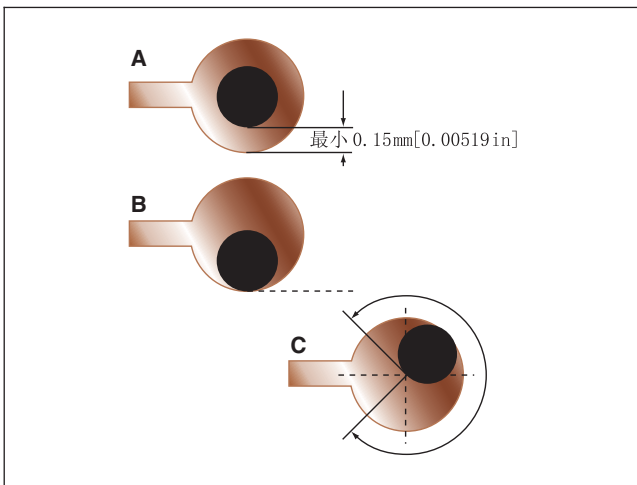
- Holes are centered in the lands.
- 孔位于焊盘中心。

**Acceptable - Class 3 (可接受条件 - 3级)**

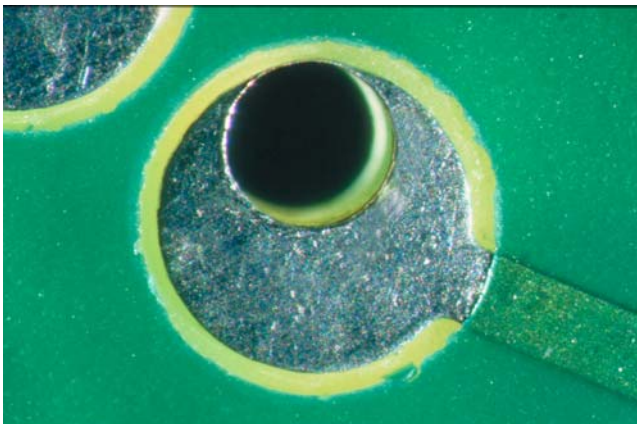
- Annular ring measures 0.15 mm [0.00591 in] or more in any direction. (See item A in Figure 2104b) The minimum external annular ring may have a 20% reduction of the minimum annular ring at the measurement area due to defects such as pits, dents, nicks, pinholes or splay.
- 任意方向的环宽均不小于0.15mm[0.00591in] (见图2104b中的A项)。测量区域内的最小外层环宽, 由于诸如麻点、凹坑、缺口、针孔或斜孔等缺陷的存在, 可以再减少20%。

**Acceptable - Class 2 (可接受条件 - 2级)**

- 90° breakout is allowed. (See item B in Figure 2104b.)
- If breakout occurs at the conductor to land junction area, the conductor is not reduced by more than 20% of the minimum conductor width specified on the engineering drawing or the production master nominal.
- 90°破坏是允许的 (见图2104b中的B项)。
- 如破坏发生在焊盘与导体的连接区, 导体宽度的减少不大于工程图纸或生产底版标称最小导体宽度的20%。

**Acceptable - Class 1 (可接受条件 - 1级)**

- 90° breakout is allowed. (See item C in Figure 2104b.)
- If breakout occurs at the conductor to land junction area, the conductor is not reduced by more than 30% of the minimum conductor width specified on the production master nominal.
- 90°破坏是允许的 (见图2104b中的C项)。
- 如破坏发生在焊盘与导体的连接区, 导体宽度的减少不大于工程图纸或生产底版标称最小导体宽度的30%。

**Nonconforming - Class 1,2,3 (不符合条件 - 1,2,3级)**

- Defects either do not meet or exceed above criteria.

**不符合条件 - 1,2,3级**

- 缺陷不符合或超出上述要求。

### 2.11 Flatness (平整度)

Flatness of printed boards is determined by two characteristics of the product; these are known as bow and twist. The bow condition is characterized by a roughly cylindrical or spherical curvature of the printed board while its four corners are in the same plane (see Figure 211a). Twist is the printed board deformation parallel to the diagonal of the printed board such that one corner is not in the same plane to the other three (see Figure 211b). Circular or elliptical printed boards must be evaluated at the highest point of vertical displacement. Bow and twist may be influenced by the printed board design as different circuit configurations or layer construction of multilayer printed boards can result in different stress or stress relief conditions. Printed board thickness and material properties are other factors that influence the resulting printed board flatness.

**Bow and Twist** Bow, twist, or any combination thereof, **shall** be determined by physical measurement and percentage calculation in accordance with IPC-TM-650, Method 2.4.22. End products shall be assessed in the delivered form.

印制板的平整度是由产品的两种特性来确定的：即弓曲和扭曲。弓曲的状况通过把印制板的四个角处在同一平面上，大致成圆柱形或球面弯曲进行确定；而扭曲是板的变形平行于板的对角线，板的一个角不与其它三个角在同一平面上。（见图211b）圆形或椭圆形的印制板必须在最高点作垂直位移的评定。弓曲和扭曲可能会受印制板设计的影响，因为不同的布线或多层印制板的层结构可能导致产生不同的应力或应力消除的状况。印制板的厚度及材料性能是影响印制板平整度的其他因素。

**弓曲及扭曲** 弓曲、扭曲或其组合**应当**按IPC-TM-650测试方法2.4.22中的物理测量方法进行测量并计算百分比。成品板应当按照接收态的形态进行评估。

2.11 Flatness (cont.) (平整度 (续))



图211a



图211b

**Acceptable - Class 1,2,3 (可接受条件 - 1,2,3级)**

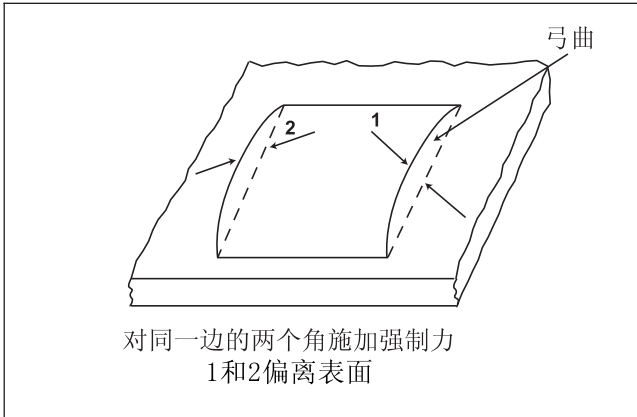
- For printed boards using surface mount components, the bow and twist **shall** be 0.75% or less.
- For all other printed boards, bow and twist **shall** be 1.50% or less.
- 对于采用表面贴装元器件的印制板，弓曲和扭曲**应当**小于等于0.75%。
- 对于所有其它印制板，弓曲和扭曲应当小于等于1.50%。

**Nonconforming - Class 1,2,3 (不符合条件 - 1,2,3级)**

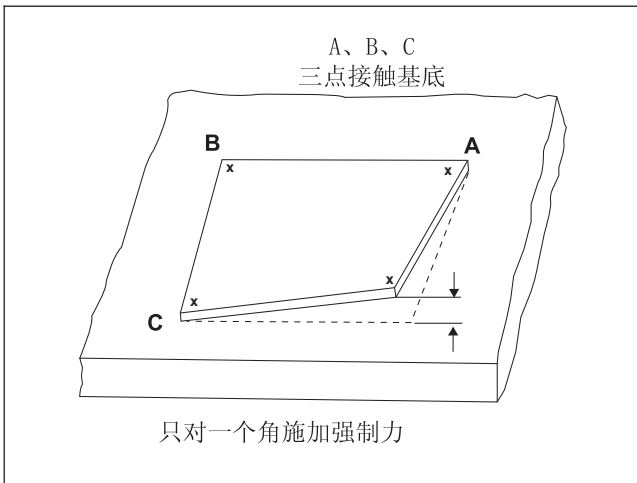
- Defects either do not meet or exceed above criteria.
- 缺陷不符合或超出上述要求。

## Introduction (引言)

The purpose of this section is to provide acceptability requirements for those characteristics which are internal to the printed board. These include the following characteristics in the base material, PTHs, internal conductive copper pattern, treatments to the internal copper, and internal ground/power/thermal planes, as described below:

- Subsurface imperfections in printed board material, such as delamination, blistering, and foreign inclusions.
- Subsurface imperfections to multilayer printed boards, such as voids, delamination, blistering, cracks, ground plane clearance and layer to layer spacing.
- PTH anomalies, including size, annular ring, nailheading, plating thickness, plating voids, nodules, cracks, resin smear, inadequate or excessive etchback, wicking, inner layer (post) separation, and solder mask thickness.
- Internal conductor anomalies, such as over or under etch, conductor cracks and voids, uneven or inadequate oxide treatment, and foil thickness.
- Visual observations made on cross-sections only.

本章的目的是为印制板各种内部特性提供可接受性要求。这些内部特性包括在基材、镀覆孔、内层铜导电图形、内层铜箔的处理、内部接地层/电源层/散热层内的特性，如下：

- 印制板材料表面下的瑕疵，如分层、起泡和外来夹杂物。
- 多层印制板表面下的瑕疵，例如空洞、分层、起泡、裂纹、接地层的余隙和层间的间距。
- 镀覆孔的异常，包括孔的尺寸、环宽、钉头、镀层厚度、镀层空洞、结瘤、裂缝、树脂钻污、凹蚀不足或过蚀、芯吸、内层与孔壁分离及阻焊膜厚度等。
- 内层导体的异常，例如蚀刻过度或不足、导体裂缝及空洞、氧化处理不均匀或不充分，以及铜箔厚度等。
- 仅对显微切片进行目检观察。



## Introduction (引言)

This section covers the acceptability requirements of dielectric materials. Dielectric materials are evaluated after thermal stress. Requirements for evaluations made in the as received condition should be stated on the procurement documentation.

本节涵盖了介质材料的可接受性要求。在热应力测试后对介质材料进行评定。应该在采购文件中规定接收状态下的评定要求。

## 3.1.1 Laminate Voids/Cracks (Outside Thermal Zone) (层压板空洞/裂缝 (受热区外))



图311a

## Notes:

1. The thermal zone extends 0.08 mm [0.0031 in] beyond the end of the land, either internal or external, extending furthest into the laminate area.
2. Laminate anomalies or imperfections that exist entirely in the Zone A area are not evaluated on specimens which have been exposed to thermal stress or rework simulation. Boundary line voids/cracks that overlap Zone A and Zone B as shown in Figure 311e or are entirely in Zone B shall meet the requirements of 3.1.1.1.
3. Delamination/Blistering is evaluated in both Zone A and Zone B.
4. Laminate anomalies or imperfections in the non-evaluation areas (at either end of the microsection specimen) are not evaluated on specimens which have been exposed to thermal stress or rework simulation.

## 注:

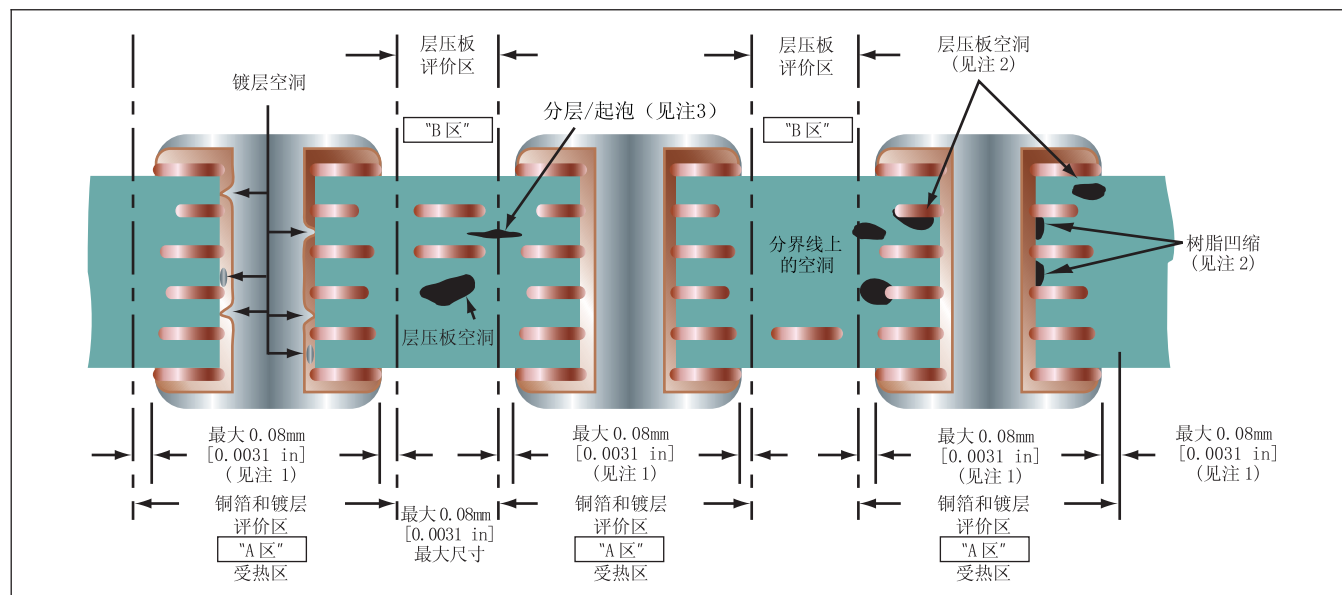
1. 受热区是指从内层或外层中最靠外的焊盘边缘向层压板延伸0.08mm[0.0031in]所包含的区域。
2. 经过热应力或模拟返工后, A区内出现的层压板异常或瑕疵不做评价。如图311e所示, 跨连了A区和B区或完全在B区内的分界线上的空洞/裂缝则应当满足3.1.1节的要求。
3. A区和B区均进行分层/起泡的评定。
4. 经过热应力或模拟返工后, 样板上非评价区(显微切片试样的任一端)出现的层压板异常或瑕疵不做评价。



图311b

Visual observations made on cross-sections only. (仅对显微切片进行目检观察。)

## Target Condition - Class 1,2,3 (目标条件 - 1,2,3级)

- Uniform and homogeneous laminate.
- 层压板均匀一致。

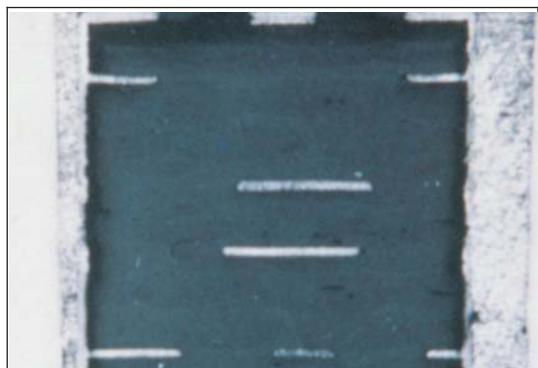
3.1.1 Laminate Voids/Cracks (Outside Thermal Zone) (cont.) (层压板空洞/裂缝 (受热区外) (续))



图311c

**Acceptable - Class 2,3 (可接受条件 - 2,3级)**

- Void/crack less than or equal to 0.08 mm [0.0031 in] and does not violate minimum dielectric spacing.
- Laminate anomalies or imperfections, such as voids/cracks or resin recession, in Zone A areas that have been exposed to thermal stress and rework simulation.
- Multiple voids/cracks between two adjacent plated-through holes in the same plane that do not have combined length which exceeds these limits.
- 空洞/裂缝小于或等于0.08mm[0.0031in]且不违反最小介质间距要求。
- 经热应力及模拟返工测试后，允许A区出现诸如空洞/裂缝或树脂凹缩等层压板异常或瑕疵。
- 当同一层面上相邻的两镀覆孔间出现多个空洞/裂缝时，其累加长度未超出上述限制。

**Acceptable - Class 1 (可接受条件 - 1级)**

- Void/crack less than or equal to 0.15 mm [0.00591 in] and does not violate minimum dielectric spacing.
- Laminate anomalies or imperfections, such as voids/cracks or resin recession, in Zone A areas that have been exposed to thermal stress and rework simulation.
- Multiple voids/cracks between two adjacent plated-through holes in the same plane that do not have combined length which exceeds these limits.
- 空洞/裂缝小于或等于0.15mm[0.00591in]且不违反最小介质间距要求。
- 经热应力及模拟返工测试后，允许A区出现诸如空洞/裂缝或树脂凹缩等层压板异常或瑕疵。
- 当同一层面上相邻的两个镀覆孔间出现多个空洞裂缝时，其累加长度未超出上述限制。

Visual observations made on cross-sections only. (仅对显微切片进行目检观察。)

### 3.1.1 Laminate Voids/Cracks (Outside Thermal Zone) (cont.) (层压板空洞/裂缝 (受热区外) (续))



图311d

#### Nonconforming - Class 1,2,3 (不符合条件 - 1,2,3级)

- Defects either do not meet or exceed above criteria.
- 缺陷不符合或超出上述要求。

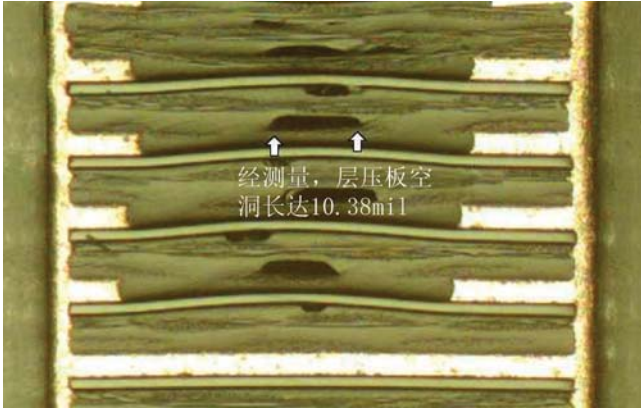

图311e

### 3.1.2 Registration/Conductor to Holes (导体与孔的重合度)

Registration of conductors is typically determined with respect to PTH lands. Requirements are established through minimum internal annular ring (see 3.3.1).

导体与孔的重合度通常是相对于镀覆孔焊盘来测定的。其要求是通过最小内层环宽来确定的 (见3.3.1节)。

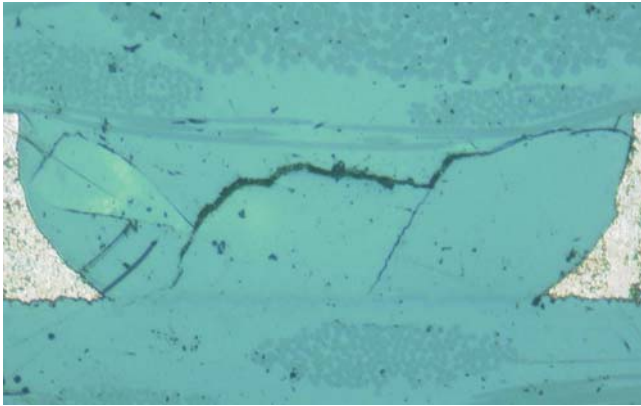
Visual observations made on cross-sections only. (仅对显微切片进行目检观察。)

3.1.3 Clearance Hole, Unsupported, to Power/Ground Planes (电源层/接地层上的非支撑孔, 隔离孔)



图313a



图313b

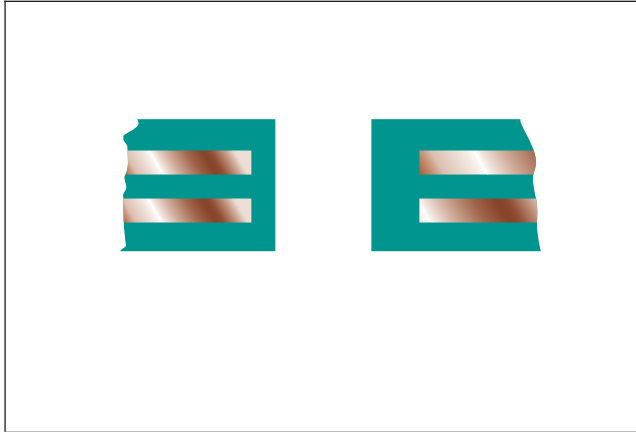

图313c

**Target Condition - Class 1,2,3 (目标条件 - 1,2,3级)**

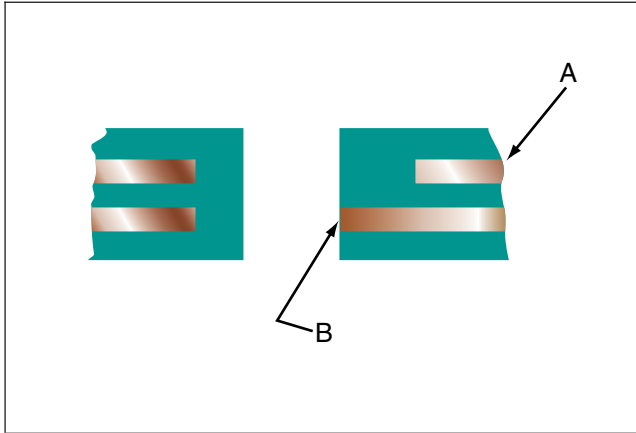
- Power/Ground plane setback meets the procurement documentation requirements.
- 电源层/接地层到隔离孔的余隙符合采购文件的要求。

**Acceptable - Class 1,2,3 (可接受条件 - 1,2,3级)**

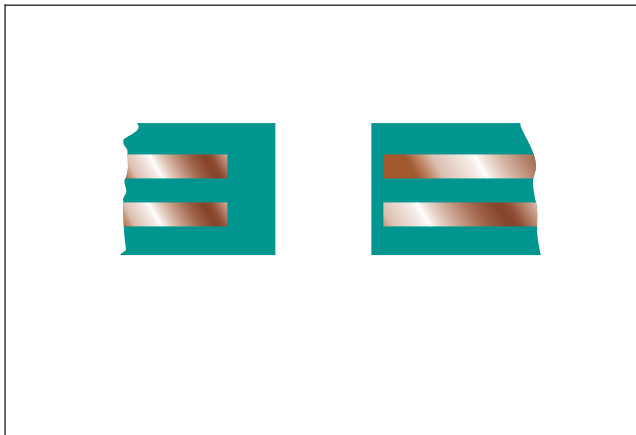
- A) Power/ground plane setback is greater than the minimum electrical conductor spacing specified on the procurement documentation.
- B) Ground plane may extend to the edge of an unsupported hole when specified in the procurement documentation.
- A) 电源层/接地层到隔离孔的余隙大于采购文件规定的最小导体间距。
- B) 当采购文件有规定时, 接地层可以延伸到非支撑孔的边缘。

**Nonconforming - Class 1,2,3 (不符合条件 - 1,2,3级)**

- Defects either do not meet or exceed above criteria.
- 缺陷不符合或超出上述要求。

Visual observations made on cross-sections only. (仅对显微切片进行目检观察。)



### 3.1.4 Delamination/Blister (分层/起泡)



图314a

**Target Condition - Class 1,2,3 (目标条件 - 1,2,3级)**

- No delamination or blistering.
- 无分层或起泡。

**Acceptable - Class 2,3 (可接受条件 - 2,3级)**

- No evidence of delamination or blistering.
- 没有分层或起泡迹象。



图314b

**Acceptable - Class 1 (可接受条件 - 1级)**

- If delamination or blistering is present, evaluate the entire printed board in accordance with 2.3.3.
- 如出现分层或起泡，按2.3.3节的要求来评定整个印制板。

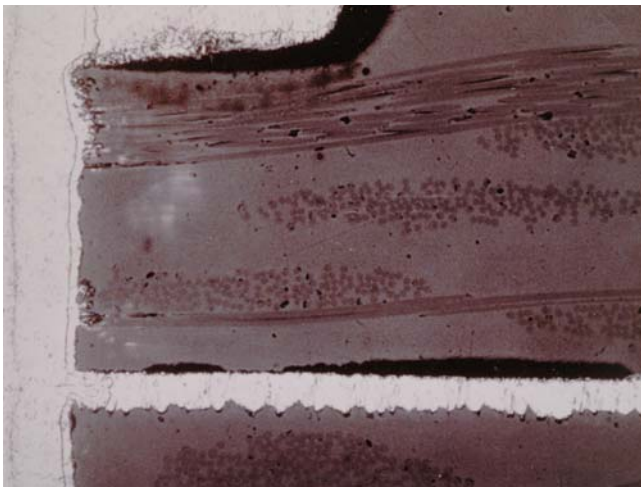

图314c

**Nonconforming - Class 1,2,3 (不符合条件 - 1,2,3级)**

- Defects either do not meet or exceed above criteria.
- 缺陷不符合或超出上述要求。

Visual observations made on cross-sections only. (仅对显微切片进行目检观察。)

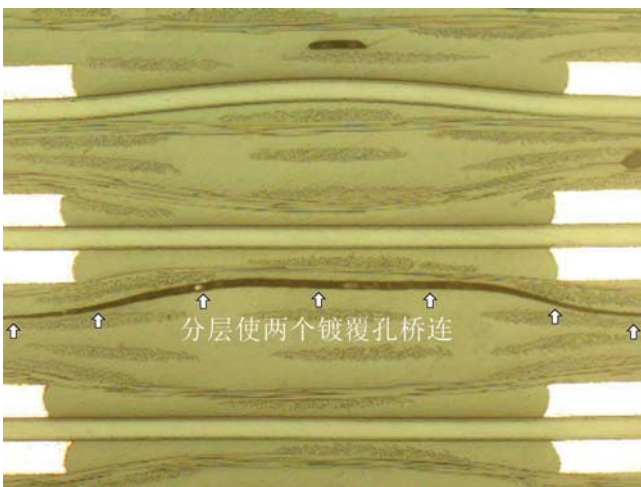
## 3.1.5 Etchback (凹蚀)

Acceptable etchback or negative etchback exhibits the evidence that resin smear has been removed from the innerlayer copper/ drilled hole interface. An example of resin smear appears in Figure 315a. There is data, pro and against, that etchback is more reliable than negative etchback and vice versa. This all depends on what type of copper plating, copper foil, and weight of the foil being used. Excessive etchback as well as excessive negative etchback are not the target condition. Excessive etchback, in both instances, has an adverse effect on the reliability of the PTH life.

可接受的凹蚀或负凹蚀表现为树脂钻污已经从内层铜箔与钻孔界面处清除干净。图315a为钻污的一个例子。有数据表明，“凹蚀”要比“负凹蚀”更为可靠，但也有相反的观点，这取决于所采用的电镀铜、铜箔的类型及铜箔的厚度。过度的凹蚀以及过度的负凹蚀都不是理想状况。这两种情况下的过度凹蚀对镀覆孔的可靠性都会造成负面影响。

**Etchback:** The etchback process, also known as positive etchback, is used to remove the dielectric material. The evidence of resin material being etched back theorizes that all resin smear has been removed and in addition, a three way interfacial bond occurs between the PTH copper to the innerlayer copper foil. The theory is that three connections are more reliable than one. The drawbacks of etchback are that it creates rough holes which could create PTH barrel cracks. Excessive etchback also contributes to stresses that might create foil cracks. Shading is defined as a condition that occurs during an etchback process in which the dielectric material immediately next to the foil is not removed completely. This can occur even though an acceptable amount of etchback may have been achieved elsewhere. Proper measurement locations for etchback are shown in Figure 315b.

**凹蚀:** 凹蚀过程，也称之为正凹蚀，用于去掉介质材料。树脂材料被凹蚀的迹象说明，所有的树脂钻污已被完全去除，同时镀覆孔的铜和内层铜箔之间产生出三维界面的结合。三维连接比一个界面连接更加可靠。但缺点是凹蚀会造成孔壁粗糙，使孔壁产生裂缝。过度的凹蚀也会导致可能引起内层铜箔破裂的应力。凹蚀阴影是指在凹蚀过程中，紧靠铜箔的树脂并未被完全清除。这种情况即使在别处已达到可接受的凹蚀情况时也会发生。适当的凹蚀测量位置如图315b所示。

**Negative Etchback:** The theory here is that in order for the internal foil to be etched back/cleaned, you need to eliminate the smear. The benefits for utilizing negative etchback are that the process does not create a stress point at the internal plane, as does the etchback process, and it results in a very smooth/uniform copper barrel hole wall. The smooth hole wall and negative etchback are beneficial especially for the copper plating of high-reliability long term life applications. The drawback of negative etchback, if excessive, is that it may create innerlayer separation due to entrapped air pockets/contamination. This section is not intended to prove or disprove which etchback process is preferred. There are many printed board manufacturers that are very successful in utilizing both the etchback and negative etchback processes. It is up to the individual designer/user, depending on the material, copper plating, copper foil and application, to specify which etchback process should be employed.

**负凹蚀:** 其理论是：为了将内层铜箔凹蚀又清洁，首先要把钻污全部清除。负凹蚀的优点是不会像凹蚀那样在内层界面处产生应力集中点，负凹蚀可以形成一个非常平滑而均匀的孔壁。平滑的孔壁及负凹蚀对于高可靠、长寿命应用的铜镀层特别有利。负凹蚀的缺点是，如果负凹蚀过度，由于凹处夹留气泡和污染物，可能引起内层分离。本节无意于对优先选用哪种凹蚀工艺表示赞成或反对。有很多印制板制造商不管是采用凹蚀还是负凹蚀工艺都很成功。应该采用哪种特定的凹蚀工艺，取决于各个设计者或用户，同时也取决于所采用的材料、铜电镀、铜箔和应用等因素。



图315a 去钻污实例



图315b 凹蚀测量

Visual observations made on cross-sections only. (仅对显微切片进行目检观察。)

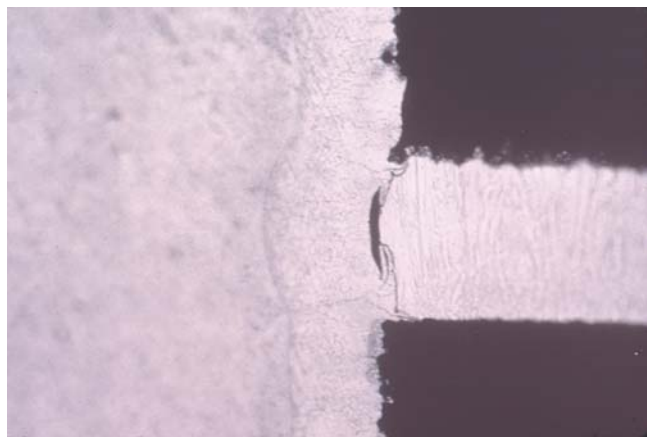
### 3.1.5.1 Etchback (凹蚀)

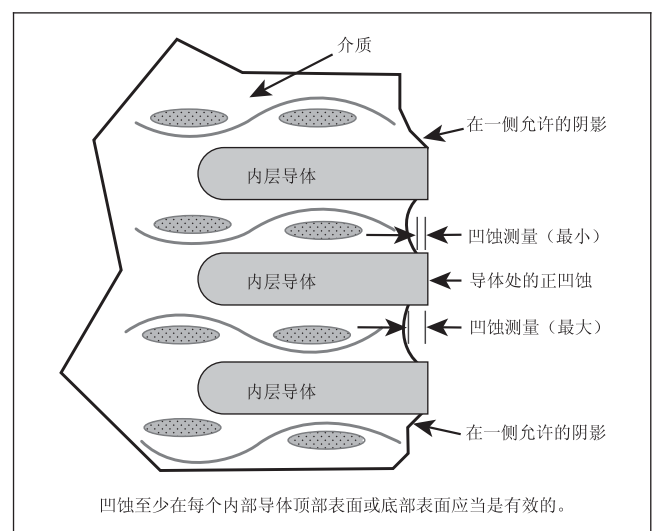

图3151a

#### Target Condition - Class 1,2,3 (目标条件 - 1,2,3级)

- Uniform etchback to a preferred depth of 0.013 mm [0.000512 in].
- 均匀地凹蚀到最佳深度0.013mm[0.000512in]。

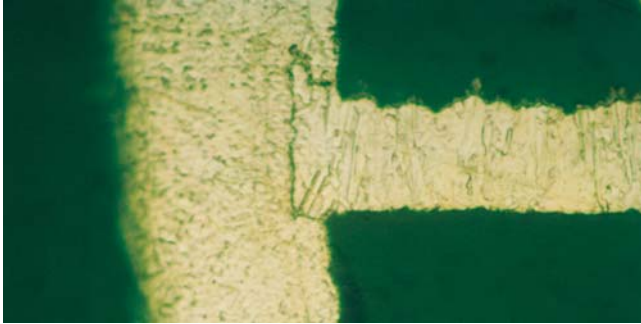

图3151b

#### Acceptable - Class 1,2,3 (可接受条件 - 1,2,3级)

- Etchback between 0.005 mm [0.00020 in] and 0.08 mm [0.0031 in].
- Shadowing is permitted on one side only of each land.
- 凹蚀深度介于0.005mm[0.0002in]至0.08mm[0.0031in]之间。
- 每个焊盘只允许一侧出现凹蚀阴影。

Visual observations made on cross-sections only. (仅对显微切片进行目检观察。)

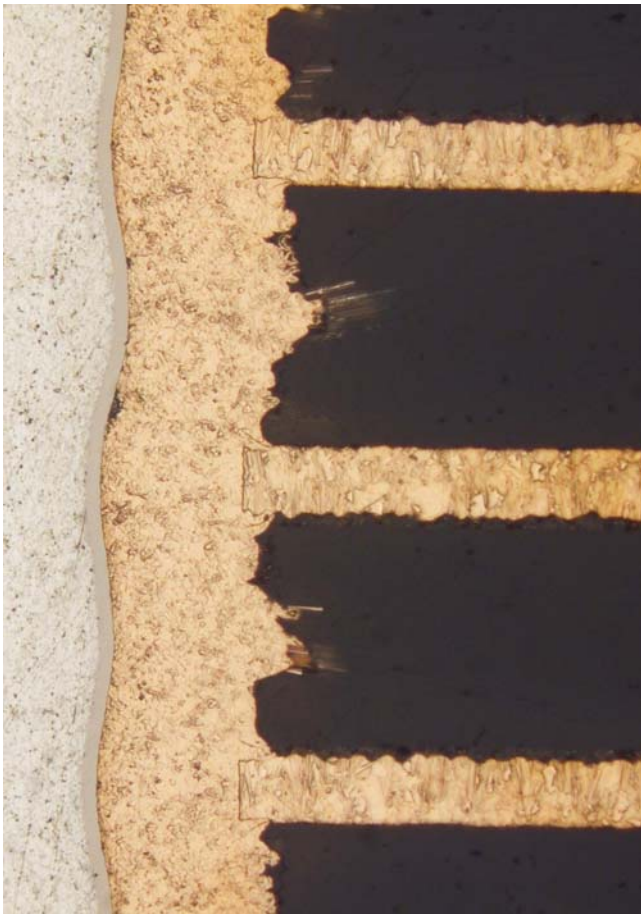

### 3.1.5.1 Etchback (cont.) (凹蚀 (续))



图3151c

**Nonconforming - Class 1,2,3 (不符合条件 - 1,2,3级)**

- Defects either do not meet or exceed above criteria.
- 缺陷不符合或超出上述要求。



图3151d

Visual observations made on cross-sections only. (仅对显微切片进行目检观察。)

### 3.1.5.2 Negative Etchback (负凹蚀)



图3152a

**Target Condition - Class 1,2,3 (目标条件 - 1,2,3级)**

- Uniform negative etchback of copper foil 0.0025 mm [0.0000984 in].
- 铜箔上均匀的负凹蚀深度为0.0025mm[0.0000984in]。



图3152b

**Acceptable - Class 3 (可接受条件 - 3级)**

- Negative etchback less than 0.013 mm [0.000512 in].
- 负凹蚀小于0.013mm[0.000512in]。

**Acceptable - Class 1,2 (可接受条件 - 1,2级)**

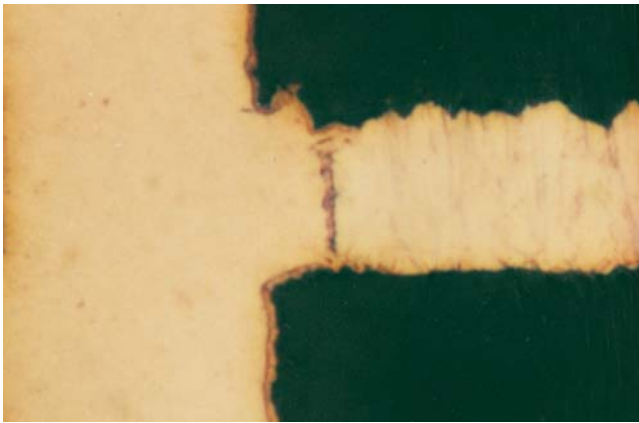
- Negative etchback less than 0.025 mm [0.000984 in].
- 负凹蚀小于0.025mm[0.000984in]。



图3152c

**Nonconforming - Class 1,2,3 (不符合条件 - 1,2,3级)**

- Defects either do not meet or exceed above criteria.
- 缺陷不符合或超出上述要求。

Visual observations made on cross-sections only. (仅对显微切片进行目检观察。)

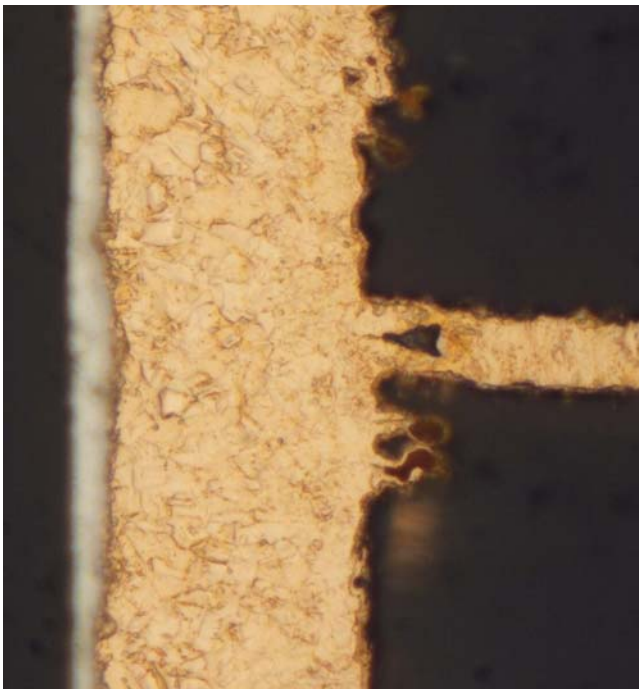

### 3.1.6 Smear Removal (去钻污)

Smear removal is defined as the removal of resin debris which results from the formation of the hole wall.

去钻污是指去除孔壁成形过程中产生的树脂残渣。



图316a



图316b

#### Acceptable - Class 1,2,3 (可接受条件 - 1,2,3级)

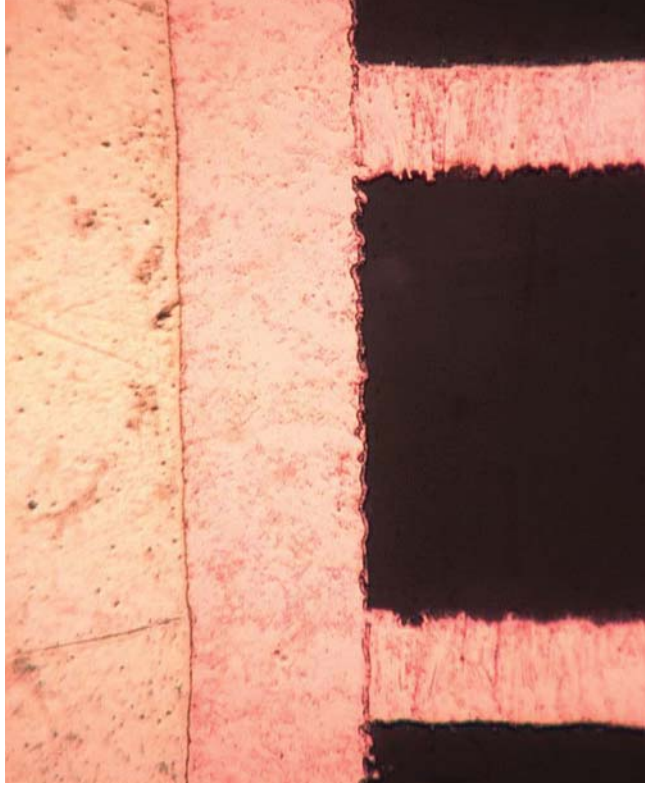
- Smear removal has not been etched back greater than 0.025 mm [0.001 in].
- Random tears or drill gouges producing small areas where the 0.025 mm [0.001 in] depth has been exceeded **shall** be evaluated as etchback per 3.1.5.1.
- Smear removal sufficiently meets the acceptability criteria for plating separation (3.3.14).
- 去钻污产生的凹蚀未超过0.025mm[0.001in]。
- 对于小块区域上随机的撕裂或钻槽已超过0.025mm[0.001in]的情况，**应当**按3.1.5.1节作为凹蚀进行评价。
- 去钻污完全符合3.3.14节镀层分离的可接受性准则。

Visual observations made on cross-sections only. (仅对显微切片进行目检观察。)

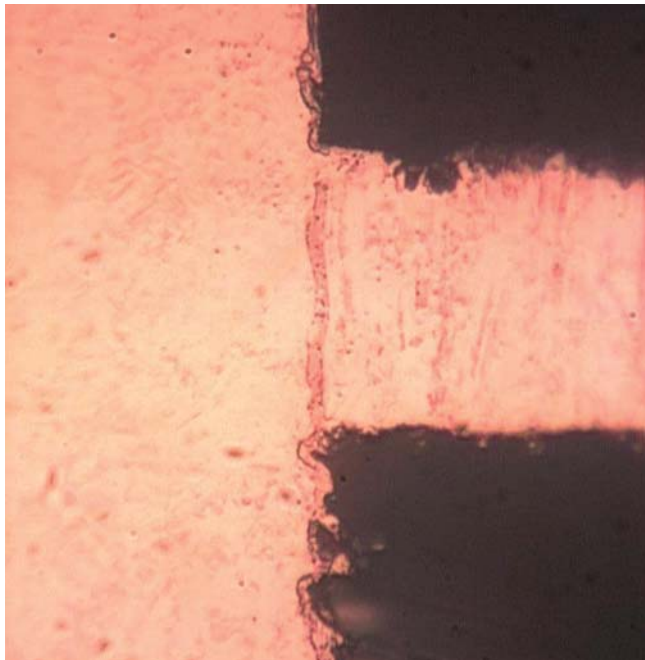
### 3.1.6 Smear Removal (cont.) (去钻污 (续))



图316c

#### Nonconforming - Class 1,2,3 (不符合条件 - 1,2,3级)

- Defects either do not meet or exceed above criteria.
- 缺陷不符合或超出上述要求。

Visual observations made on cross-sections only. (仅对显微切片进行目检观察。)

3.1.7 Dielectric Material, Clearance, Metal Plane for Supported Holes (金属层上支撑孔的介质间距)

Metal planes are used for mechanical reinforcement and/or electromagnetic shielding for printed boards. Many requirements are the same as for metal-core printed boards.

金属层用作印制板机械增强和（或）电磁屏蔽层，很多要求与金属芯印制板相同。



图317a

**Target Condition - Class 1,2,3 (目标条件 - 1,2,3级)**

- Metal plane setback exceeds the procurement documentation requirements.
- 金属层的余隙大于采购文件的要求。

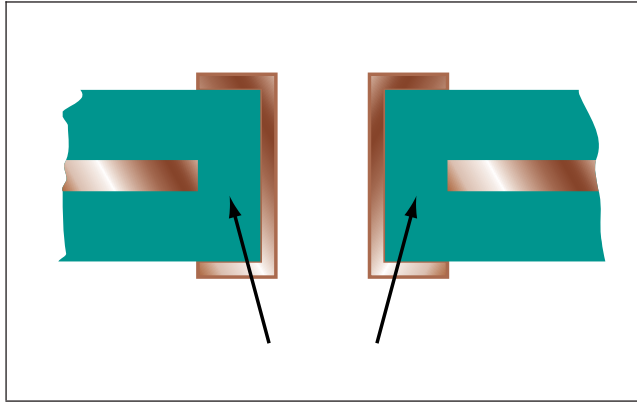

图317b

**Acceptable - Class 1,2,3 (可接受条件 - 1,2,3级)**

- Metal plane setback is equal to or greater than 0.1 mm [0.0040 in] (when a value is not specified by the procurement documentation).
- Metal plane setback does not reduce the conductor spacing to less than the specified minimum on the procurement documentation.
- 金属层的余隙等于或大于0.1mm[0.004in]（当采购文件未给出规定值时）。
- 金属层的余隙没有使导体间距减少到小于采购文件规定的最小值。

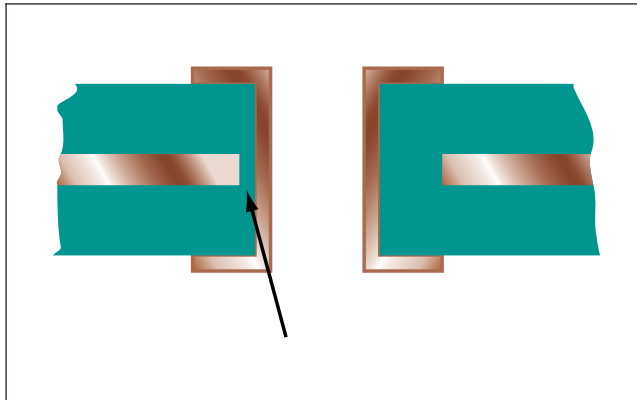

图317c

**Nonconforming - Class 1,2,3 (不符合条件 - 1,2,3级)**

- Defects either do not meet or exceed above criteria.
- 缺陷不符合或超出上述要求。

Visual observations made on cross-sections only. (仅对显微切片进行目检观察。)

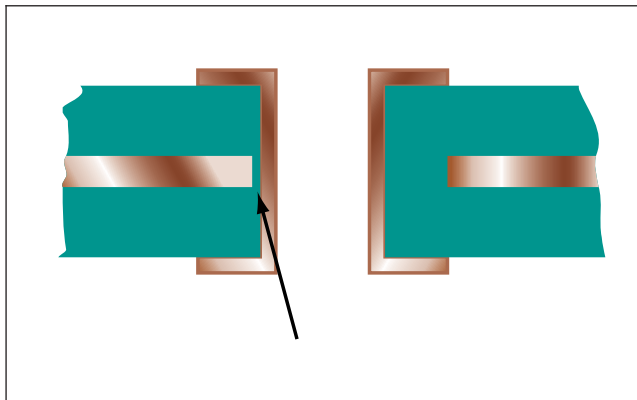
## 3.1.8 Layer-to-Layer Spacing (层间间距)

Minimum dielectric thickness is the maximum material condition used for the electrical voltage dielectric strength requirements.

最小介质厚度是耐电压介质强度要求的最大材料条件。



图318a

#### Target Condition - Class 1,2,3 (目标条件 - 1,2,3级)

- The minimum dielectric thickness meets the requirements of the procurement documentation.
- 最小介质厚度满足采购文件的要求。

#### Acceptable - Class 1,2,3 (可接受条件 - 1,2,3级)

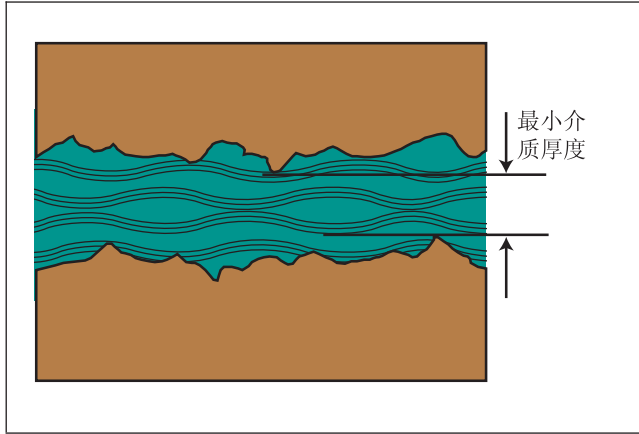
- The minimum dielectric thickness meets the minimum requirements of the procurement documentation.
- If the minimum dielectric spacing and the number of reinforcing layers are not specified, the minimum dielectric spacing **shall be** 0.09 mm [0.0035 in] and the number of reinforcing layers **shall be** selected by the supplier.
- Low profile copper foils should be used with dielectrics below 0.09 mm [0.0035 in].
- 最小介质厚度满足采购文件的最低要求。
- 如果最小介质间距和增强层的层数未作规定，则最小介质间距**应当**为0.09mm[0.0035in]，且增强层的层数**应当**由供应商选择。
- 应该使用介质低于0.09mm[0.0035in]的低粗糙度铜箔。

#### Nonconforming - Class 1,2,3 (不符合条件 - 1,2,3级)

- Defects either do not meet or exceed above criteria.
- 缺陷不符合或超出上述要求。

#### Notes:

- 1: Products designed for transmission line impedance applications may have special requirements and measurement method specified on procurement documentation.
- 2: When the nominal dielectric thickness on the drawing is less than 90  $\mu\text{m}$  [3,543  $\mu\text{in}$ ], the minimum dielectric spacing is 25  $\mu\text{m}$  [984  $\mu\text{in}$ ] and the number of reinforcing layers may be selected by the supplier.

#### 注:

1. 为传输线阻抗应用而设计的产品，可在采购文件中规定特殊要求和测量方法。
2. 当图纸上的标称介质厚度小于90 $\mu\text{m}$ [3543 $\mu\text{in}$ ]时，则最小介质间距为25 $\mu\text{m}$ [984 $\mu\text{in}$ ]，而增强层的层数可以由供应商选择。

Visual observations made on cross-sections only. (仅对显微切片进行目检观察。)

### 3.1.9 Resin Recession (树脂凹缩)

**Resin Recession:** A separation between the plated barrel of the hole and the dielectric material on the hole wall.

**树脂凹缩:** 孔壁镀层与孔壁的介质材料之间出现分离的现象。



图319a

**Acceptable - Class 1,2,3 (可接受条件 - 1,2,3级)**

- Resin recession is acceptable following thermal stress testing.
- 热应力测试后的树脂凹缩是可接受的。

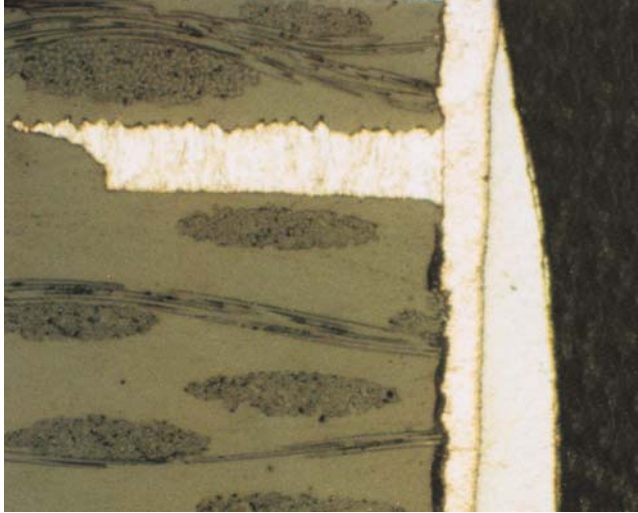

图319b

Visual observations made on cross-sections only. (仅对显微切片进行目检观察。)



3.1.10 Hole Wall Dielectric/Plated Barrel Separation (Hole Wall Pullaway) (孔壁介质与孔壁镀层分离 (孔壁拉脱))

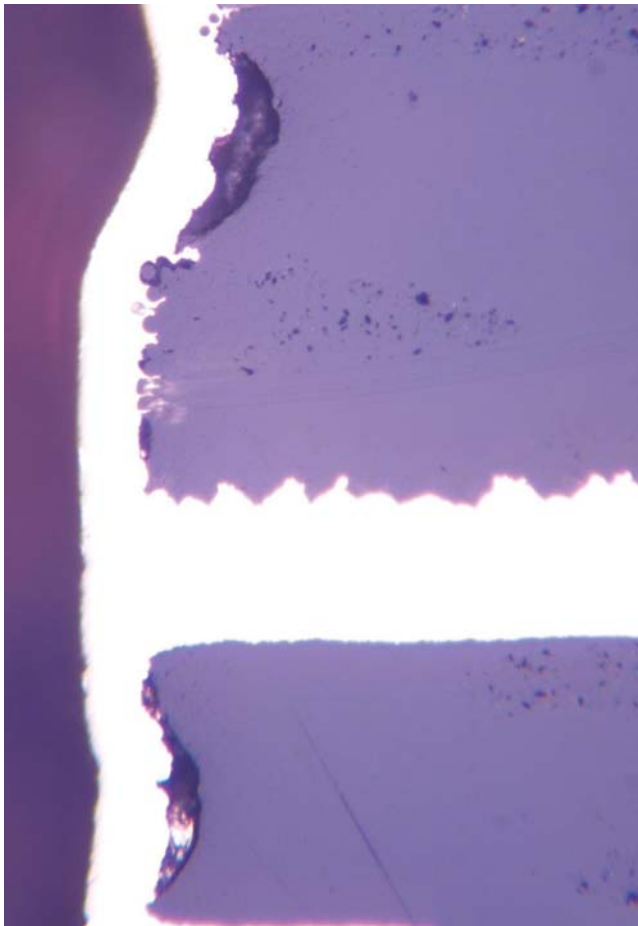

图3110a

**Acceptable - Class 1,2,3 (可接受条件 - 1,2,3级)**

- Dimensional and plating requirements of IPC-6010 performance series are met.
- 尺寸和镀层满足IPC-6010性能系列文件的要求。



图3110b

**Nonconforming - Class 1,2,3 (不符合条件 - 1,2,3级)**

- Defects either do not meet or exceed above criteria.
- 缺陷不符合或超出上述要求。

Visual observations made on cross-sections only. (仅对显微切片进行目检观察。)

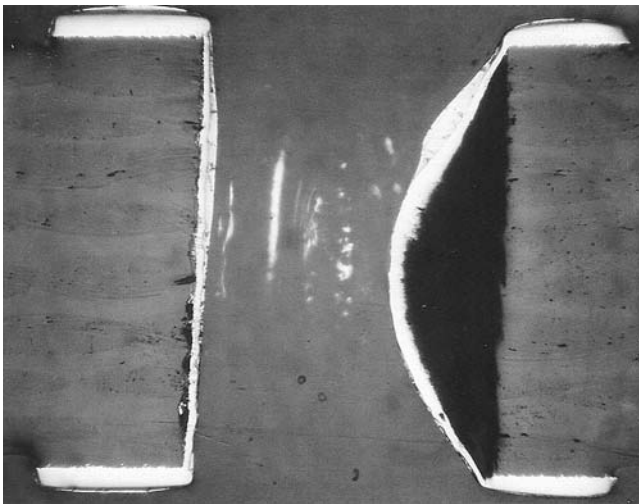
## Introduction (引言)

This section covers acceptability requirements for printed board etching, innerlayers, and impedance controlled products. An acceptable etching process must result in all residual metal being removed with no evidence of contamination remaining on the product.

Over etching is cause for rejection when potential slivers result from excessive overhang of metal resist plating or when the finished conductor widths are less than specification requirements.

Under etching is cause for rejection when spurious metal remains on the product to the extent that spacing between conductors is less than specification requirements or if conductor width requirements are exceeded.

Conductor width is defined as the observable width of the copper conductor excluding organic or metallic resists unless otherwise specified. The “Minimum Conductor Width” often specified on the procurement documentation or performance document is usually measured at the base of the conductor and may not be the actual narrowest width of the conductor when observed in cross section or often when viewed from the surface. An observation from the surface may not be adequate for acceptance of some products and etching processes. Where resistance per unit length is a requirement, a measurement of the average width of the cross-sectional area may be necessary. Where impedance control is required, a determination of the maximum conductor width may be important for the calculating impedance and a cross-section is often required.

Considerable variation in etch configurations is possible due to different etchants, resists and plated metal thicknesses. The conductor width may increase or decrease from the production artwork due to techniques used in processing during the imaging and developing operations. To achieve the “Design Width of Conductor,” the production master artwork often has conductor width adjustments made during plotting. The amount of adjustment of a conductor width on the “Production Master” may be 0.025 to 0.05 mm [0.001 to 0.0020 in]. Determination of adjustment is made by experimentation and compensation for an increase or decrease of the conductor width during plating or etching.

The illustrations in 3.2.1 are intended as a guideline to illustrate some of the edge geometry conditions which may result from different processing methods and illustrate the configurations of “Outgrowth,” “Undercut” and “Overhang.”

## Introduction (引言)

本节涵盖了印制板的蚀刻、内层和阻抗可控产品的可接受性要求。可接受的蚀刻工艺必须保证产品上所有多余金属已被除去且没有留下污染的痕迹。

如果过度蚀刻引起金属抗蚀镀层过大的突沿而产生潜在的金属镀屑，或者造成完工的导体宽度小于规定的要求，则过度蚀刻是拒收的理由。

如果蚀刻不足而造成产品上产生的金属残留物使导体之间的间距小于规定的要求，或者导体宽度超过了规定的要求，蚀刻不足也是引起拒收的理由。

除非另有规定，导体宽度是指可观察到的铜导体宽度，但不包括有机的或金属的抗蚀层。采购文件或性能文件中规定的“最小导体宽度”通常是在导体的基底处测量的，而不是按显微切片所观察到的或通常从表面所观察到的实际最窄宽度。从表面观察不能作为一些产品和蚀刻工艺的验收依据。当导体的单位长度电阻有要求时，则可能有必要对导体横截面的平均宽度进行测量。当有阻抗控制要求时，最大导体宽度的测定对计算阻抗可能很重要，同时往往要求对导体进行剖切。

由于蚀刻剂、抗蚀剂和金属镀层的厚度的不同，蚀刻后图形的变异可能相当大。同时在成像和显影操作过程中由于采用的工艺技术的不同，也会使导体宽度可能比生产底片的宽度大或小。为了达到“导体设计宽度”，在光绘生产底版的过程中往往要调整导体的宽度。对“生产底版”导体宽度的调整量可从0.025mm至0.05mm[0.000984in至0.0020in]。尺寸的调整通过电镀或蚀刻过程的导体宽度增大或减小程度的实验而加以确定。

3.2.1节中的示意图用来表明不同的加工方法可能产生的几种导体边缘的几何形状，并图示了“镀层增宽”、“侧蚀”和“镀层突沿”等不同外形。

## Introduction (引言)

Definitions used in evaluating etched conditions (see IPC-T-50) include:

评价蚀刻状况时所用到的定义（见IPC-T-50）包括：

**Outgrowth:** The increase in conductor width at one side of the conductor, caused by plating buildup over that delineated by the production master.

**镀层增宽:** 由于镀层堆积引起的导体一侧宽度增加，超过生产底版的绘制宽度。

**Undercut:** The distance on one edge of the conductor measured parallel to the printed board surface from the outer edge of the conductor, including etch resists, to the maximum point indentation to the copper conductor.

**侧蚀:** 从导体一侧外边缘（包括抗蚀层）到同一侧铜导体的最大凹入点与板面平行的间隔距离。

**Overhang:** The sum of the outgrowth and undercut.

**镀层突沿:** 镀层增宽和侧蚀量的总和。

**Design width of conductor:** The width of a conductor as delineated or noted on the procurement documentation.

- Notes:**
1. The “Production Master” may be adjusted for process methods and the artwork conductor width may differ from the design width.
  2. Design width of conductor is most often stated as a minimum as measured at the base of the conductor. For impedance controlled circuits, a  $\pm$  tolerance may be placed on conductor width.

**导体设计宽度:** 采购文件上绘制的或标注的导体宽度。

- 注:**
1. “生产底版”可以按加工方法进行调整，而照相底版的导体宽度可以不同于导体设计宽度。
  2. 导体设计宽度通常是指在导体底部测量所得的最小宽度。对于阻抗可控的线路，其导体宽度可设置正负公差要求。

**Production Master:** A 1:1 scale pattern which is used to produce one or more printed boards within the accuracy specified on the procurement documentation.

**生产底版:** 用于生产一块或多块印制板的按1:1比例绘制的图形，精度在采购文件规定的范围以内。

**Etch Factor:** The ratio of the depth of etch to the amount of lateral etch.

**蚀刻系数:** 蚀刻深度与侧向蚀刻量之比。

### 3.2.1 Etching Characteristics (蚀刻特性)



图321a

“A” Point of Narrowest Conductor Width: This is not “Minimum Conductor Width” noted on procurement documentation or performance specifications.

“B” Conductor Base Width: The width that is measured when “Minimum Conductor Width” is noted on the procurement documentation or performance specification.

“C” Production Master Width: This width usually determines the width of the metal or organic resist on the etched conductor.

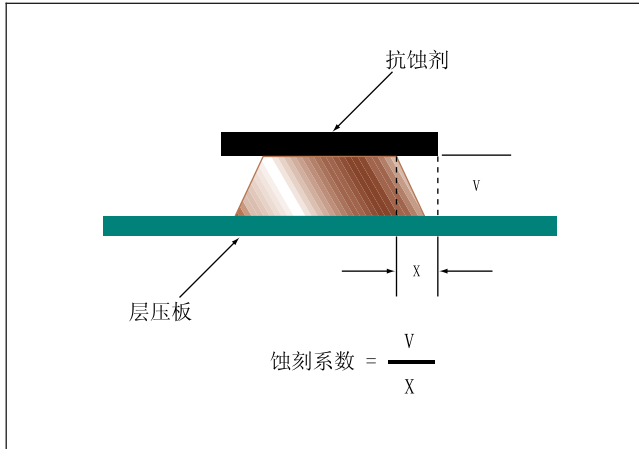
Design width of the conductor is specified on the procurement documentation and is most often measured at the conductor base “B” for compliance to “Minimum Conductor Width” requirements.

“A” 导体最窄处宽度：这不是采购文件或性能规范所指的“最小导体宽度”。

“B” 导体底宽：当采购文件或性能规范标注有“最小导体宽度”时，测量此宽度。

“C” 生产底版导体宽度：这个宽度通常确定被蚀刻导体上金属或有机抗蚀剂的宽度。

在采购文件规定导体设计宽度，通常测量导体基体底部“B”的宽度，以确定是否符合“最小导体宽度”的要求。

The following two configurations show that conductor width may be greater at the surface than at the base:

下面两种不同导体外形图，显示导体表面的宽度可以大于底部的宽度。



图321b

热熔前的图形电镀（干膜抗蚀剂）

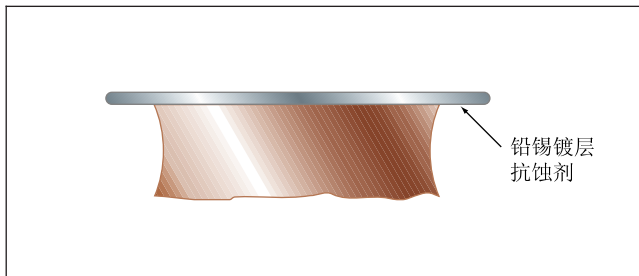

图321d

去膜前的全板电镀（干膜抗蚀剂）

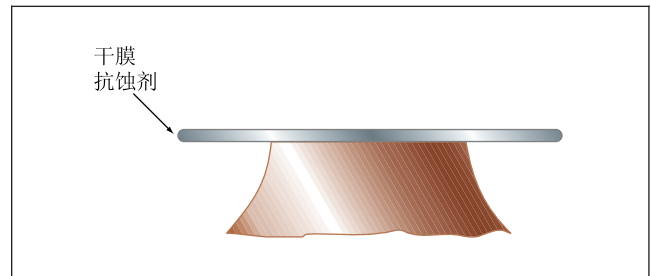

图321c

蚀刻后的内层

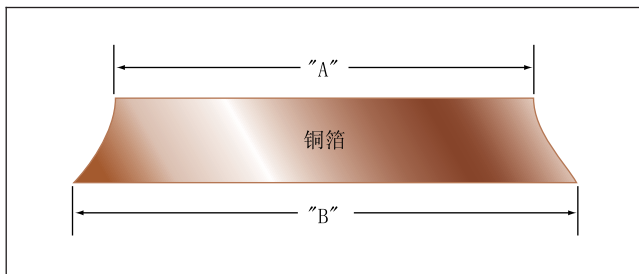

图321e

用于埋孔的内层电镀层

Visual observations made on cross-sections only. (仅对显微切片进行目检观察。)

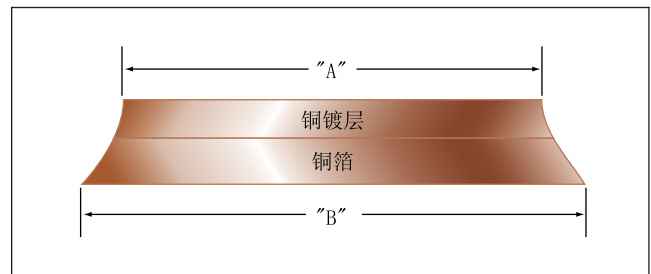

3.2.1 Etching Characteristics (cont.) (蚀刻特性 (续))



图321f 具有镀层增宽的图形电镀 (干膜抗蚀剂)



图321h 具有镀层增宽的图形电镀 (液态抗蚀剂)

**Note:** The extent of outgrowth, if present, is related to the dry film resist thickness. Outgrowth occurs when the plating thickness exceeds the resist thickness.

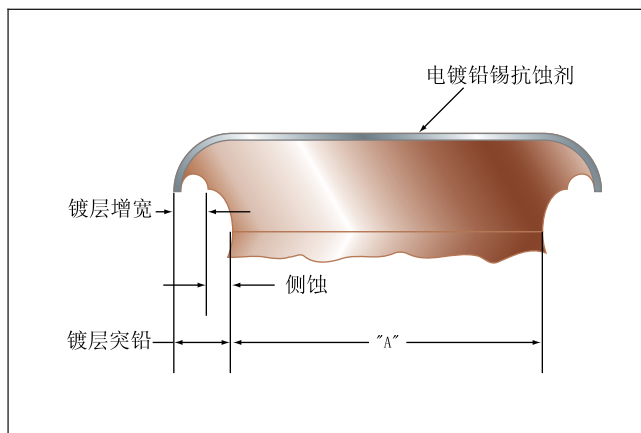
**Note:** The different etch configurations may not meet intended design requirements.

**注:** 镀层增宽的程度与干膜抗蚀剂的厚度有关。当镀层厚度超过抗蚀剂厚度时, 就会产生镀层增宽。

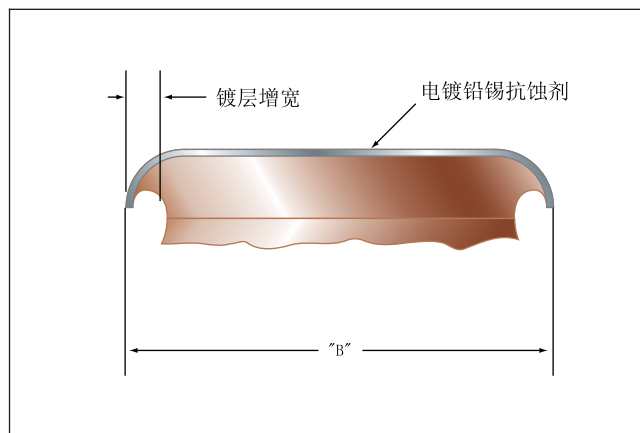
**注:** 由于蚀刻外形的不同可能不能满足设计目的要求。



图321g 薄铜箔与图形电镀 (抗蚀剂)



图321i 随着表面阻剂W的不同, 导体有效宽度与导体的宽度可能会不相同

Visual observations made on cross-sections only. (仅对显微切片进行目检观察。)

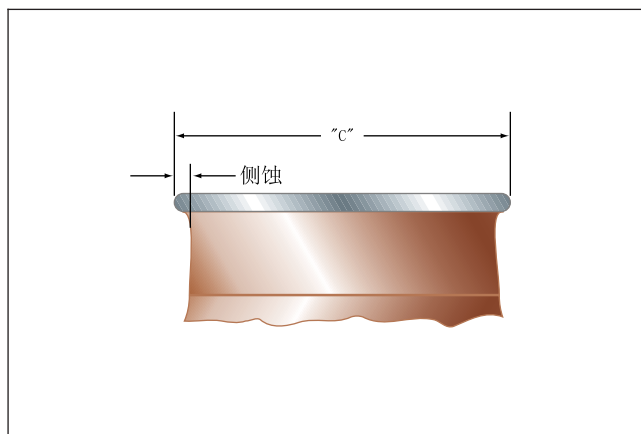
### 3.2.2 Print and Etch (丝印及蚀刻)

The copper conductor may consist of combinations of copper foil, copper plating and electroless copper. Metal resist, solder coatings, and reflowed tin-lead plating that would normally be seen in a microsection are not shown in these illustrations.

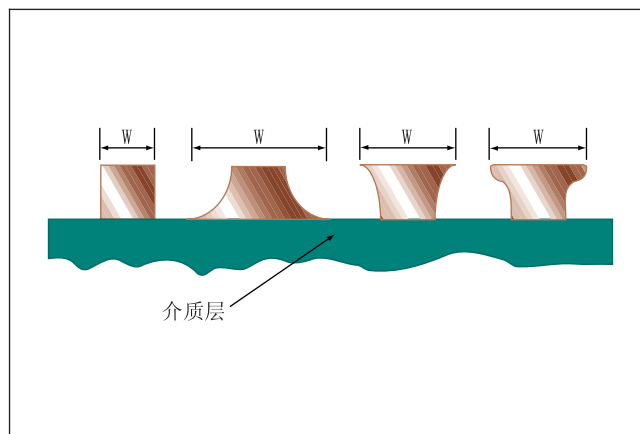
铜导体可由铜箔、铜镀层及化学沉铜层组合而成。通常在显微切片中可以看到金属抗蚀层、焊料涂覆层及热熔锡铅镀层，在这里没有给出图示。



图322a

**Target Condition - Class 1,2,3**  
(目标条件 - 1,2,3级)

- Conductor width exceeds minimum requirement.
- 导体宽度大于最小宽度要求。

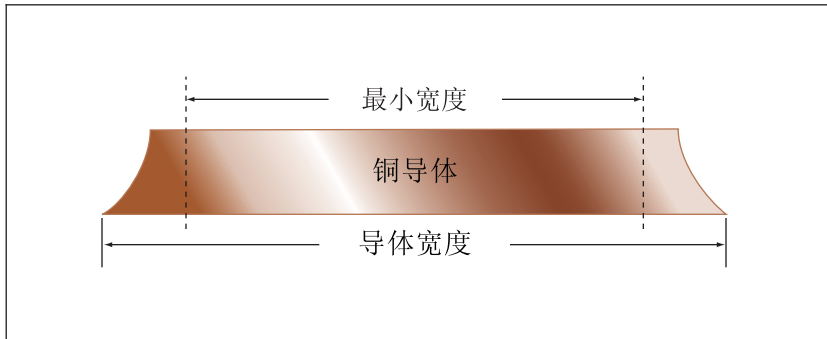

图322b

**Acceptable - Class 1,2,3**  
(可接受条件 - 1,2,3级)

- Conductor width meets minimum requirement.
- 导体宽度满足最小宽度要求。

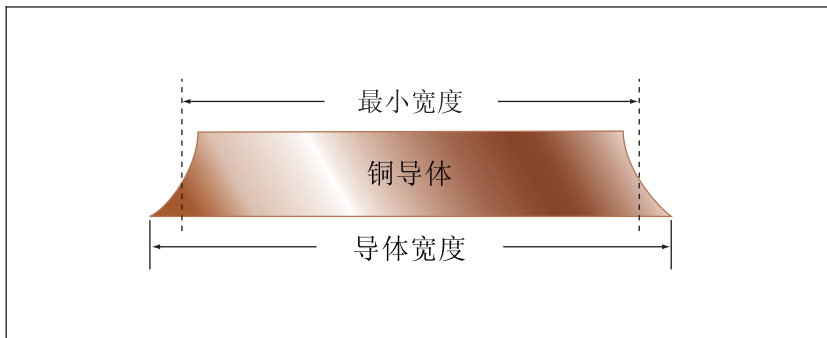

图322c

**Nonconforming - Class 1,2,3**  
(不符合条件 - 1,2,3级)

- Defects either do not meet or exceed above criteria.
- 缺陷不符合或超出上述要求。

Visual observations made on cross-sections only. (仅对显微切片进行目检观察。)

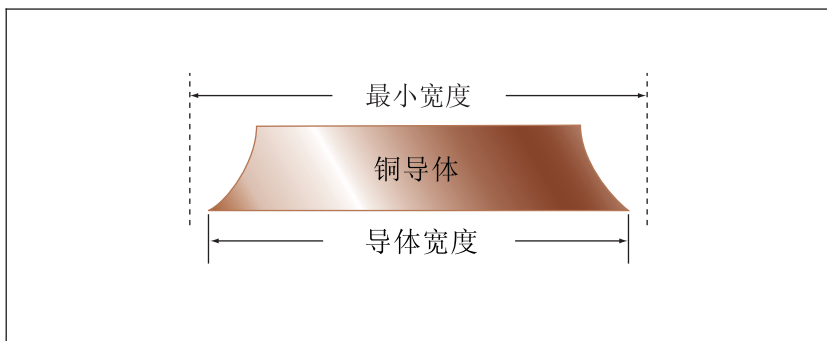
## 3.2.3 Surface Conductor Thickness (Foil Plus Plating) (表面导体厚度 (铜箔加上镀层))

Unless otherwise specified on the procurement documentation, the minimum total (copper foil plus copper plating) conductor thickness after processing shall be in accordance with Table 3-1.

除非采购文件另有规定，加工后最小总导体厚度（铜箔加上铜镀层）应当满足表3-1的规定：

Table 3-1 External Conductor Thickness after Plating (表3-1 电镀后外层导体厚度)

Weight <sup>1,4</sup>	Absolute Cu Min. (IPC-4562 less 10% reduction) ( $\mu\text{m}$ ) [ $\mu\text{in}$ ]	Plus minimum plating for Class 1 and 2 (20 $\mu\text{m}$ ) [787 $\mu\text{in}$ ] <sup>2</sup>	Plus minimum plating for Class 3 (25 $\mu\text{m}$ ) [984 $\mu\text{in}$ ] <sup>2</sup>	Maximum Variable Processing Allowance Reduction <sup>3</sup> ( $\mu\text{m}$ ) [ $\mu\text{in}$ ]	Minimum Surface Conductor Thickness after Processing ( $\mu\text{m}$ ) [ $\mu\text{in}$ ]	
					Class 1 & 2	Class 3
重量 <sup>1,4</sup>	铜绝对最小值 (IPC-4562 规定值减10%) ( $\mu\text{m}$ ) [ $\mu\text{in}$ ]	对于1级和2 级产品， 加上最小镀层 (20 $\mu\text{m}$ ) [787 $\mu\text{in}$ ] <sup>2</sup>	对于3级产品， 加上最小镀层 (25 $\mu\text{m}$ ) [984 $\mu\text{in}$ ] <sup>2</sup>	加工中允许 减少的 最大值 ( $\mu\text{m}$ ) [ $\mu\text{in}$ ] <sup>3</sup>	加工后的最小表面导体厚度 ( $\mu\text{m}$ ) [ $\mu\text{in}$ ]	
					1级和2级	3级
1/8 oz.	4.60 [181]	24.60 [967]	29.60 [1,165]	1.50 [59]	23.1 [909]	28.1 [1,106]
1/4 oz.	7.70 [303]	27.70 [1,091]	32.70 [1,287]	1.50 [59]	26.2 [1,031]	31.2 [1,228]
3/8 oz.	10.80 [425]	30.80 [1,213]	35.80 [1,409]	1.50 [59]	29.3 [1,154]	34.3 [1,350]
1/2 oz.	15.40 [606]	35.40 [1,394]	40.40 [1,591]	2.00 [79]	33.4 [1,315]	38.4 [1,512]
1 oz.	30.90 [1,217]	50.90 [2,004]	55.90 [2,201]	3.00 [118]	47.9 [1,886]	52.9 [2,083]
2 oz.	61.70 [2,429]	81.70 [3,217]	86.70 [3,413]	3.00 [118]	78.7 [3,098]	83.7 [3,295]
3 oz.	92.60 [3,646]	112.60 [4,433]	117.60 [4,630]	4.00 [157]	108.6 [4,276]	113.6 [4,472]
4 oz.	123.50 [4,862]	143.50 [5,650]	148.50 [5,846]	4.00 [157]	139.5 [5,492]	144.5 [5,689]

**Note 1.** Starting foil weight of design requirement per procurement documentation.

**Note 2.** Process allowance reduction does not allow for rework processes for weights below 1/2 oz. For 1/2 oz. and above, the process allowance reduction allows for one rework process.

**Note 3.** Reference: Min. Cu Plating Thickness

Class 1 = 20  $\mu\text{m}$  [787  $\mu\text{in}$ ] Class 2 = 20  $\mu\text{m}$  [787  $\mu\text{in}$ ] Class 3 = 25  $\mu\text{m}$  [984  $\mu\text{in}$ ]

**Note 4.** For copper foil above 4 oz., utilize the formula provided below.

注1：采购文件中起始铜箔重量的设计要求。

注2：对于重量小于1/2oz的铜箔，加工减少厚度值不允许进行返工制程。对于1/2oz或以上的铜箔，加工减少厚度值允许进行一次返工制程。

注3：参考：最小铜镀层厚度

1级=20 $\mu\text{m}$ [787 $\mu\text{in}$ ] 2级=20 $\mu\text{m}$ [787 $\mu\text{in}$ ] 3级=25 $\mu\text{m}$ [984 $\mu\text{in}$ ]

注4：对于大于4oz的铜箔，采用以下的公式。

The minimum surface conductor thickness after processing values given in Table 3-1 are determined by the following equation:

$$\text{Minimum Surface Conductor Thickness} = a + b - c$$

Where:

a = Absolute copper foil minimum (IPC-4562 nominal less 10% reduction).

b = Minimum copper plating thickness (20  $\mu\text{m}$  [787  $\mu\text{in}$ ] for Class 1 and Class 2; 25  $\mu\text{m}$  [984  $\mu\text{in}$ ] for Class 3).

c = A maximum variable processing allowance reduction.

表3-1中给出的加工后最小表面导体厚度的值由下列公式确定：

$$\text{表面导体最小厚度} = a + b - c$$

此处：

a = 铜箔最小厚度绝对值（比IPC-4562标称值少10%）。

b = 最小铜镀层厚度（1级和2级为20 $\mu\text{m}$ [787 $\mu\text{in}$ ]；3级为25 $\mu\text{m}$ [984 $\mu\text{in}$ ]）。

c = 加工允许减少的最大值。

### 3.2.4 Foil Thickness – Internal Layers (内层铜箔厚度)

Minimum foil thickness (or conductor thickness) is the maximum continuous coplanar thickness that will conduct electrical current.

Individual scratches are included, but the saw-toothed shaped “dendritic” surface for metal-clad adhesion promotion is excluded from the minimum foil thickness determination, as shown in Figure 324a.

最小铜箔厚度（或导体厚度）是传导电流的最大的连续共面厚度。

确定最小铜箔厚度时，包括个别的划痕，但用于加强金属箔粘结强度的锯齿状“树枝形”表面除外，如图324a所示。



图324a

The minimum internal layer foil thickness after processing **shall** be in accordance with Table 3-2.

加工后所有级别产品的最小内层铜箔厚度应当符合表3-2的规定：

Table 3-2 Internal Layer Foil Thickness after Processing

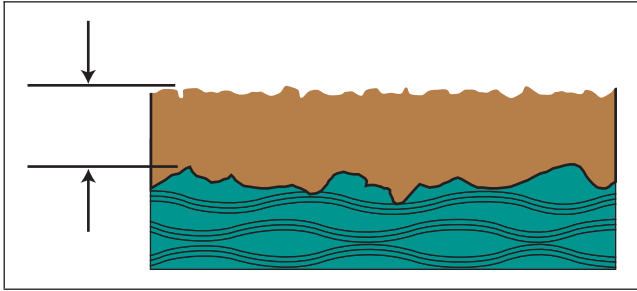
Weight	Absolute Cu Min. (IPC-4562 less 10% reduction) (μm) [μin]	Maximum Variable Processing Allowance Reduction <sup>1</sup> (μm) [μin]	Minimum Final Finish after Processing (μm) [μin]
重量	铜绝对最小值（比IPC-4562规定值减少10%）(μm) [μin]	加工允许的最大减少量 <sup>1</sup> (μm) [μin]	加工后成品导体最小厚度 (μm) [μin]
1/8 oz. [5.10]	4.60 [181]	1.50 [59]	3.1 [122]
1/4 oz. [8.50]	7.70 [303]	1.50 [59]	6.2 [244]
3/8 oz. [12.00]	10.80 [425]	1.50 [59]	9.3 [366]
1/2 oz. [17.10]	15.40 [606]	4.00 [157]	11.4 [449]
1 oz. [34.30]	30.90 [1,217]	6.00 [236]	24.9 [980]
2 oz. [68.60]	61.70 [2,429]	6.00 [236]	55.7 [2,193]
3 oz. [102.90]	92.60 [3,646]	6.00 [236]	86.6 [3,409]
4 oz. [137.20]	123.50 [4,862]	6.00 [236]	117.5 [4,626]
Above 4 oz. [137.20]	IPC-4562 value less 10% reduction	6.00 [236]	6 μm [236 μin] below minimum thickness of calculated 10% reduction of foil thickness in IPC-4562
4oz. [137.20] 以上	比IPC-4562规定值减少10%	6.00 [236]	比根据IPC-4562规定值减少10%计算出的最小厚度少6μm[236μin]

**Note 1.** Process allowance reduction does not allow for rework processes for weights below 1/2 oz. For 1/2 oz. and above, the process allowance reduction allows for one rework process.

**Note 2.** Additional platings that may be required for internal layer conductors **shall** be separately designated as a plating thickness requirement.

注1：对于重量小于1/2oz的铜箔，加工减少厚度值不允许进行返工制程。对于1/2oz及其以上的铜箔，加工减少厚度值允许进行一次返工制程。

注2：内层导体需要额外镀层时，应当单独规定其镀层厚度。

Visual observations made on cross-sections only.

## Introduction (引言)

This section identifies the acceptability characteristics in PTHs used in double-sided and multilayer rigid printed boards. Included in this section are photographic and illustrative depictions of PTH characteristics for both drilled and punched holes, with separate examples where appropriate.

The test specimen **shall** be a representative coupon such as described in IPC-2221, a portion of the printed board being tested, or a whole printed board if within size limits.

Sample holes should be selected at random. Vertical microsections, both parallel and perpendicular to a printed board edge, are recommended. Horizontal microsectioning techniques may be used as the referee. Precise encapsulation and metallurgical techniques **shall** be used to assure highly polished sections with correct part alignment and polishing to the mean of the hole diameter. The polished surface should be etched after initial smear evaluation and just prior to plating thickness measurements.

The evaluation of all properties and requirements **shall** be performed on the thermally stressed test coupon and all requirements **shall** be met. The coupons **shall** be tested after the printed board is exposed to all coating, final finish and thermal processing.

本节确定了刚性双面及多层印制板中镀覆孔的可接受性特性。包含在本节中的照片与示意图分别图示了钻孔镀覆孔或冲孔镀覆孔的特性。

试样**应当**是具有代表性的如IPC-2221中描述的附连板、待测试印制电路板的一部分，如果尺寸在范围之内，也可用整块印制板。

样品孔应该随机选取。建议采用垂直显微切片，它与板边既平行又垂直。仲裁时，可采用水平的显微剖切技术。在制作时**应当**采用精密的灌封与金相研磨技术，通过正确的调准，以确保获得高度的抛光剖面，同时使剖面抛光到孔径的中间。抛光的表面在作初始去钻污评价后、镀层厚度测量前应该进行微蚀。

对所有属性与要求的评定**应当**在经过热应力测试后的附连板上进行，且**应当**满足所有要求。**应当**在印制板经过涂敷、最终涂覆和加热工艺后测试附连板。

### Methods of Inspection:

#### • Hole Size (method optional - IPC-TM-650, Method 2.2.7)

- A. Optical
- B. Document drill blank plug or plug gages
- C. Tapered hole gage

**Note:** Hole gages must be cleaned and storage oil must be removed prior to use.

#### • Visual hole wall quality

- A. Voids, nodules, etc., - locate with unaided eye, use up to 10X magnification for verification.
- B. Discolorations, stains, etc., - use unaided eye and/or solderability tests.

### 检验方法:

#### • 孔径测量 (可选方法 - 可参考IPC-TM-650测试方法2.2.7)

- A. 光学法
- B. 标准的钻针规或塞规
- C. 锥形孔规

**注:** 孔规使用前必须洁净, 并将防锈油脂擦拭干净。

#### • 目检孔壁质量

- A. 空洞、结瘤等缺陷 - 以裸眼定位, 再用高至10倍的放大镜进行验证。
- B. 变色、污点等缺陷 - 采用以裸眼目视及/或进行可焊性测试。



## Introduction (cont.) (引言 (续))

**Microsection:****• Plating thickness measurements**

- A. Encapsulated Microsection Examination (IPC-TM-650, Method 2.1.1 or Method 2.1.1.2): The average copper thickness should be determined from three measurements, approximately equally spaced, on each side of the PTH. Do not measure in areas having isolated imperfections such as voids, cracks or nodules. Small localized areas with plating thickness less than minimum requirement are evaluated as voids.
- B. Nondestructive Method: Micro-ohm Measurements (IPC-TM-650, Method 2.2.13.1): This technique may be used to measure the average copper thickness in PTH when properly standardized. The method has application to measurement of the minimum copper thickness. Due to the dependence on uniform hole geometry this method may not be appropriate for measurement of punched PTHs. The nondestructive feature and the speed and ease of measurement make this method useful in providing variable data for statistical process control.
- C. Plating Thickness: Minimum requirements are established in IPC-6010 series.

**• Solderability**

A lot sample or representative specimen should be subjected to a solderability test utilizing Methods B, B1, C, C1, D or D1 of IPC-J-STD-003. The coating durability requirement should be pre-established. The PTHs should exhibit good wetting and capillary action.

**显微切片:****• 镀层厚度测量**

- A. 灌封的显微切片检验 (IPC-TM-650测试方法2.1.1或2.1.1.2): 铜的平均厚度应该通过三个测量值来确定, 在镀覆孔每侧壁上大约等距离选取三个测试点。不要选用有孤立缺陷的区域, 例如空洞、裂缝或结瘤等来测量镀铜厚度。小的局部区域镀层厚度低于最小要求的, 作为空洞来评定。
- B. 非破坏性方法: 微欧姆测量法 (IPC-TM-650测试方法2.2.13.1): 当此法经过适当的标定后, 这种技术可用于测量镀覆孔铜层的平均厚度。这种方法用来测量镀铜的最小厚度。由于此法与孔的形状的均匀性有关, 因此不适合用于测定冲孔的镀覆孔内的镀铜厚度。由于非破坏性的特点、快速且易于测量, 使这种方法在为“统计过程控制”(SPC)提供计量数据时非常有用。
- C. 镀层厚度: IPC-6010系列标准建立了最小厚度要求。

**• 可焊性**

所选取的一批次具有代表性的样品应该采用ANSI/J-STD-003的B、B1、C、C1、D或D1测试方法进行可焊性测试。应该事先确定涂覆层的耐久性要求。镀覆孔应该呈现良好的润湿和毛细作用。

### 3.3.1 Annular Ring – Internal Layers (内层环宽)

For multilayer printed boards, in addition to physical measurements of printed board surfaces, if internal annular ring breakout is detected in the vertical cross section, but the degree of breakout cannot be determined, internal registration may be assessed by nondestructive techniques other than microsection, such as, special patterns, probes, and/or software, which are configured to provide information on the interpolated annual ring remaining and pattern skew. Techniques include, but are not limited to the following:

- The optional F or R coupon detailed in IPC-2221.
- Custom designed electrically testable coupons.
- Radiographic (x-ray) techniques.
- Horizontal microsection.
- CAD/CAM data analysis as correlated to pattern skew by layer.

**Note:** Microsectioning or statistical sampling **shall** be used to verify correlation of the approved technique, and a calibration standard established for the specific technique employed.

If misregistration to the point of breakout is detected in vertical microsections, the concerns are that:

1. The conductor width minimum may be compromised at the land junction and,
2. There is insufficient electrical spacing.

The extent and direction of breakout **shall** be determined. Appropriate test coupons or actual production printed boards **shall** be tested at the affected area(s) and analyzed on the suspect layer(s) to determine compliance. This may be accomplished by the techniques listed above.

Measurements for internal annular ring are taken at the copper hole wall plating/internal land interface to the outer most tip of the internal land as shown in Figure 331a.



图331a

对于多层印制板，除了要测量印制板表面特性之外，如在垂直显微剖切中发现内层孔环有破坏，但不能判定破坏的程度，内层的错位则可通过除显微剖切外的非破坏性方法确定，例如特殊图形、探头及（或）软件。其原理是利用错位的孔环和偏斜的图形找到情况。这类技术包含但不限于以下几种：

- IPC-2221中详细描述的可选附连板F或R；
- 定制的可用于电气测试的附连板；
- X射线术；
- 水平显微剖切；
- 与每层图形定位相关的CAD/CAM资料分析

**注：**应当采用显微剖切或统计抽样来验证上述检测技术的符合性，及为所采用的具体技术建立的特定校准标准。

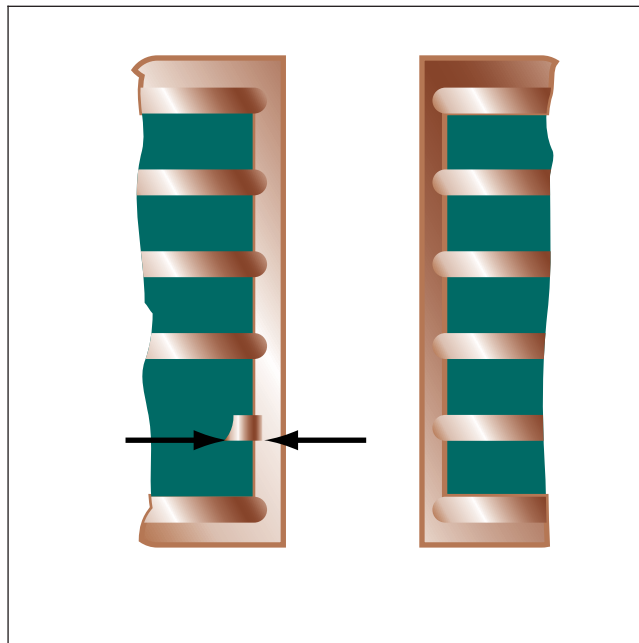
一旦在垂直显微切片上发现错位，注意下列事项：

1. 在导体与焊盘的连接区，最小导体宽度可能受到危及；
2. 没有足够的电气间距。

**应当**测定破坏的大小与方向。**应当**在适用的测试附连板或实际成品印制板的受影响区域进行测试，并分析可疑层面从而进行判定。可通过以上所列的技术进行评定。

内层环宽的测量从孔壁的铜镀层/内部连接盘界面测至内部连接盘的最外端，如图331a。

Visual observations made on cross-sections only. (仅对显微切片进行目检观察。)

### 3.3.1 Annular Ring – Internal Layers (cont.) (内层环宽 (续))



图331b

**Target Condition - Class 1,2,3 (目标条件 - 1,2,3级)**

- All holes accurately registered in the center of the lands.
- 所有的孔准确地对准焊盘的中心。

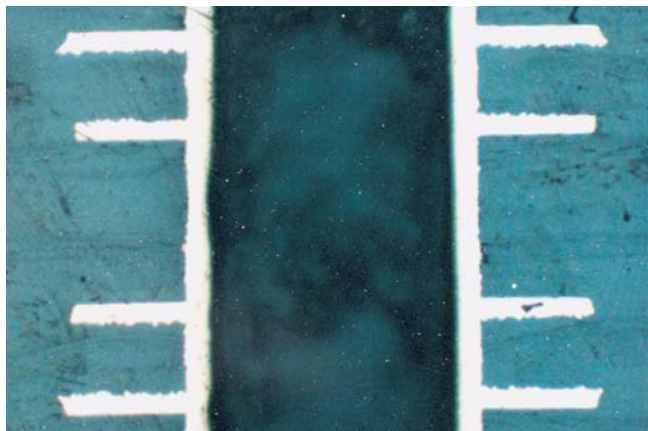

图331c

**Acceptable - Class 3 (可接受条件 - 3级)**

- Annular ring measures 0.025 mm [0.000984 in] or more.
- 环宽大于或等于0.025mm[0.000984in]。

**Acceptable - Class 2 (可接受条件 - 2级)**

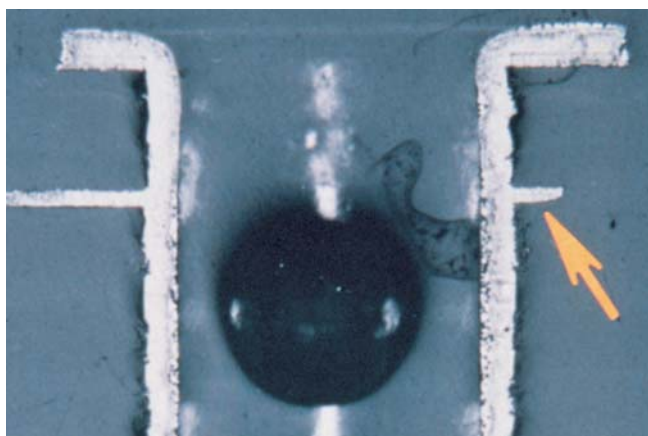
- 90° hole breakout is allowed provided the land/conductor junction is not reduced below the allowable width reduction in 2.10.1.1 and minimum lateral spacing is maintained.
- 如破环未使焊盘/导体连接区减少至小于2.10.1.1节允许的宽度减少值并保持最小侧向间距, 则允许有90°的破环。

**Acceptable - Class 1 (可接受条件 - 1级)**

- Hole breakout is allowed provided the land/conductor junction is not reduced below the allowable width reduction in 2.10.1.1 and minimum lateral spacing is maintained.
- 如破环未使焊盘/导体连接区减少至小于2.10.1.1节允许的宽度减少值并保持最小间距。



图331d

**Nonconforming - Class 1,2,3 (不符合条件 - 1,2,3级)**

- Defects either do not meet or exceed above criteria.
- 缺陷不符合或超出上述要求。

Visual observations made on cross-sections only. (仅对显微切片进行目检观察。)

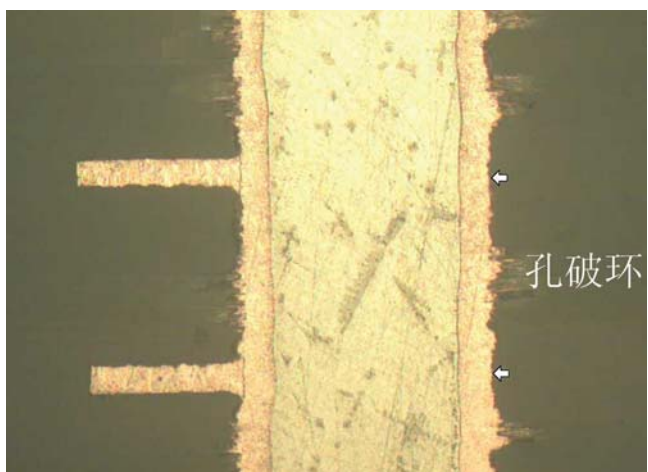
### 3.3.2 Lifted Lands – (Cross-Sections) (焊盘起翘 (显微切片))



图332a

**Target Condition - Class 1,2,3 (目标条件 - 1,2,3级)**

- No lifting of lands.
- 无焊盘起翘。

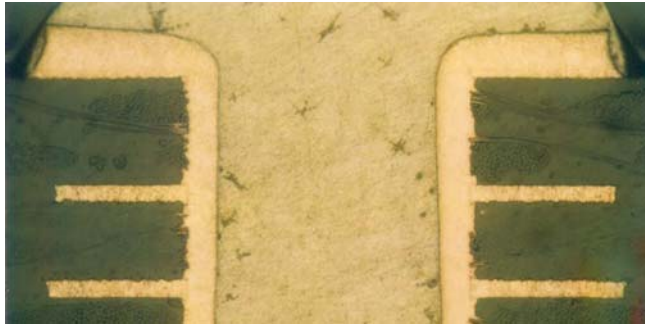

图332b

**Acceptable - Class 1,2,3 (可接受条件 - 1,2,3级)**

After thermal stress testing or rework simulation:

- Lifted lands are allowed.

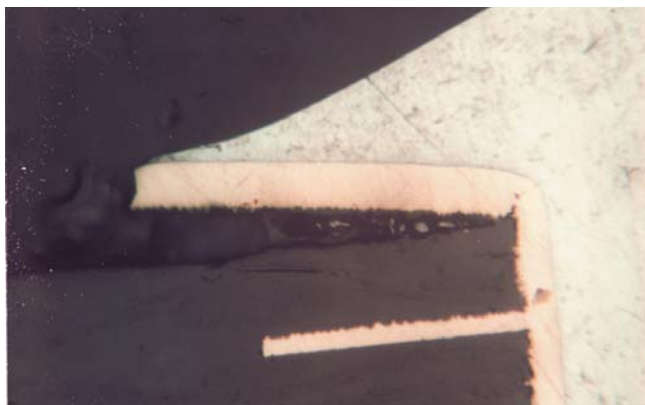
热应力测试或模拟返工后:

- 允许焊盘起翘。

Visual observations made on cross-sections only. (仅对显微切片进行目检观察。)

### 3.3.3 Foil Crack – (Internal Foil) “C” Crack (铜箔裂缝 – (内层铜箔) C型裂缝)



图333a

**Target Condition - Class 1,2,3 (目标条件 - 1,2,3级)**

- No cracks in foil.
- 铜箔无裂缝。

**Acceptable - Class 2,3 (可接受条件 - 2,3级)**

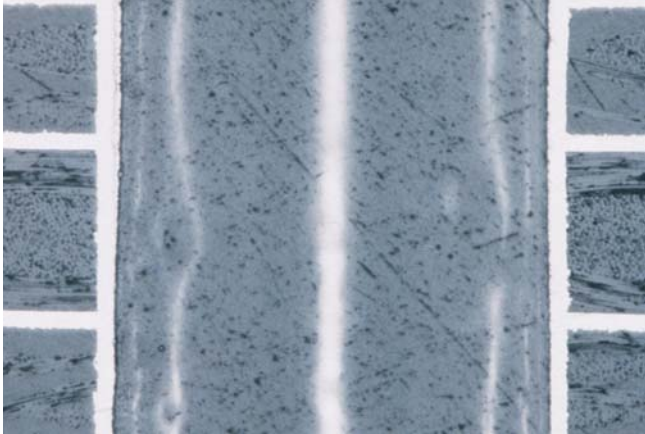
- No evidence of cracks in foil.
- 铜箔上无裂缝迹象。



图333b

**Acceptable - Class 1 (可接受条件 - 1级)**

- Allowed on one side of hole only and does not extend through foil thickness.
- 仅允许孔的一侧铜箔有裂缝，且没有穿透整个铜箔厚度。

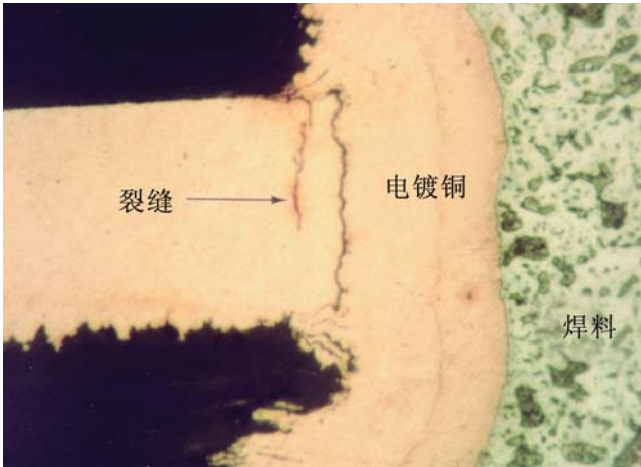

图333c

**Nonconforming - Class 1,2,3 (不符合条件 - 1,2,3级)**

- Defects either do not meet or exceed above criteria.
- 缺陷不符合或超出上述要求。

Visual observations made on cross-sections only. (仅对显微切片进行目检观察。)

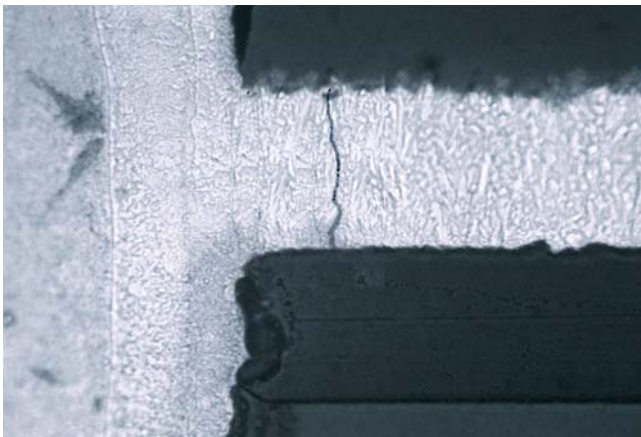

### 3.3.4 Foil Crack (External Foil) (铜箔裂缝 (外层铜箔))



图334a

**Target Condition - Class 1,2,3 (目标条件 - 1,2,3级)**

- No cracks in foil.
- 铜箔无裂缝。

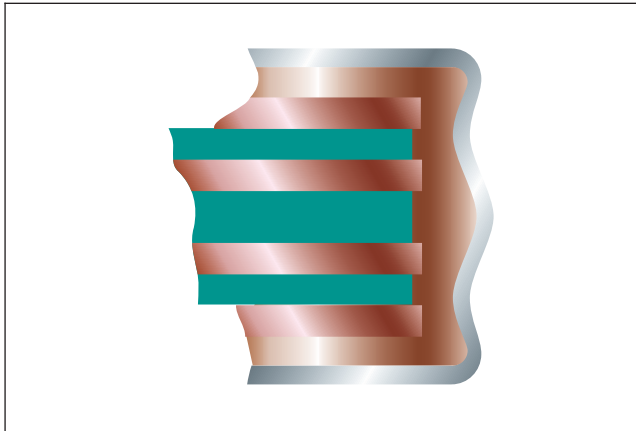

图334b

**Acceptable - Class 1,2,3 (可接受条件 - 1,2,3级)**

- Crack A
- A型裂缝。

**Acceptable - Class 1 (可接受条件 - 1级)**

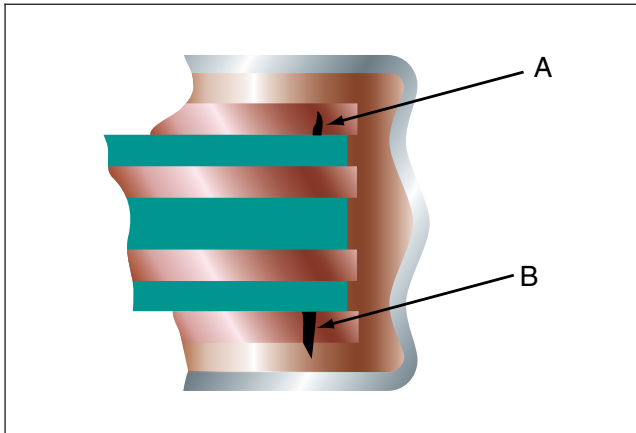
- Cracks B
- B型裂缝。



图334c

**Nonconforming - Class 1,2,3 (不符合条件 - 1,2,3级)**

- Defects either do not meet or exceed above criteria
- 缺陷不符合或超出上述要求。

**Note:** “A” Crack is a crack in external foil.

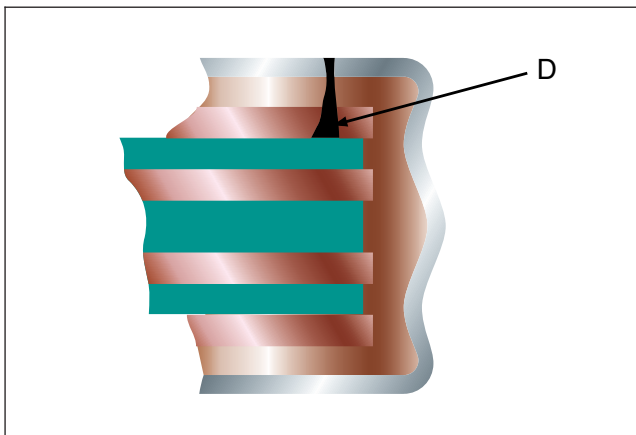
“B” Crack is a crack that does not completely break plating (minimum plating remains).

“D” Crack is a complete crack through external foil and plating.

**注:** A型裂缝是外层铜箔中的裂缝。

B型裂缝是没有完全穿透镀层的裂缝 (保留最小镀层)。

D型裂缝是已完全穿透了外层铜箔和镀层的裂缝。

Visual observations made on cross-sections only. (仅对显微切片进行目检观察。)

### 3.3.5 Plating Crack (Barrel) “E” Crack (镀层裂缝 (孔壁) – E型裂缝)



图335a

**Target Condition - Class 1,2,3 (目标条件 - 1,2,3级)**

- Barrel plating is free of cracks.
- 孔壁镀层无裂缝。

**Acceptable - Class 1,2,3 (可接受条件 - 1,2,3级)**

- No cracks in plating.
- 镀层无裂缝。



图335b

**Nonconforming - Class 1,2,3 (不符合条件 - 1,2,3级)**

- Defects either do not meet or exceed above criteria.
- 缺陷不符合或超出上述要求。



图335c

Visual observations made on cross-sections only. (仅对显微切片进行目检观察。)

3.3.6 Plating Crack – (Corner) “F” Crack (镀层裂缝 – (拐角) F型裂缝)

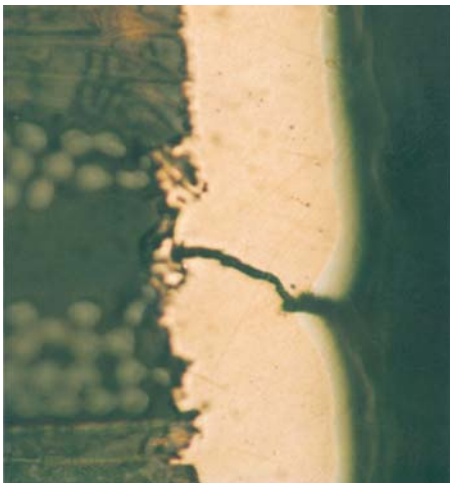

图336a



图336b

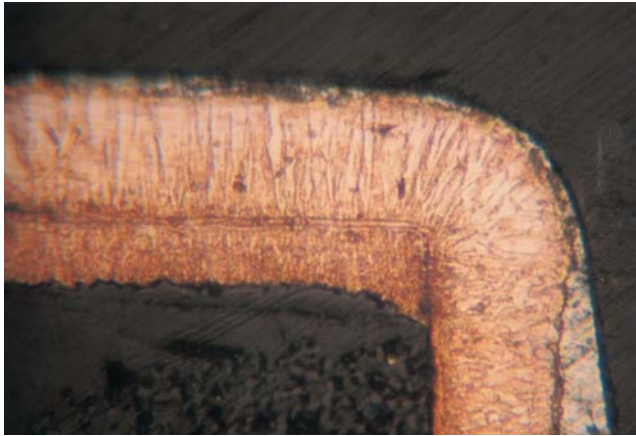

图336c

**Target Condition - Class 1,2,3 (目标条件 - 1,2,3级)**

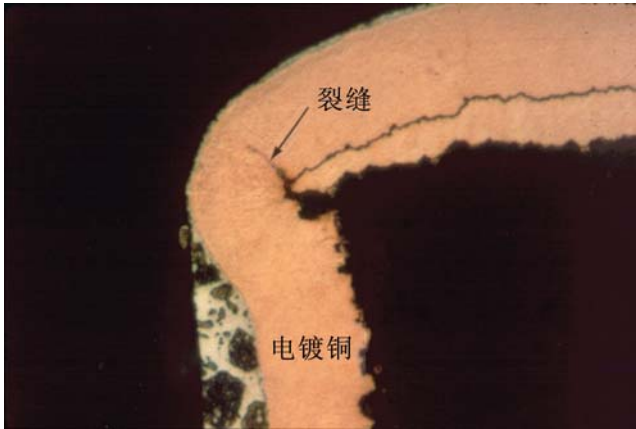
- No cracks in plating.
- 镀层无裂缝。

**Acceptable - Class 1,2,3 (可接受条件 - 1,2,3级)**

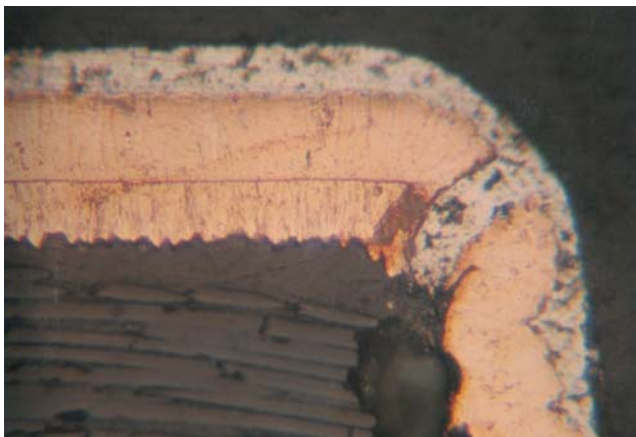
- No cracks in plating.
- 镀层无裂缝。

**Nonconforming - Class 1,2,3 (不符合条件 - 1,2,3级)**

- Defects either do not meet or exceed above criteria.
- 缺陷不符合或超出上述要求。

Visual observations made on cross-sections only. (仅对显微切片进行目检观察。)

### 3.3.7 Plating Nodules (镀层结瘤)



图337a



图337b

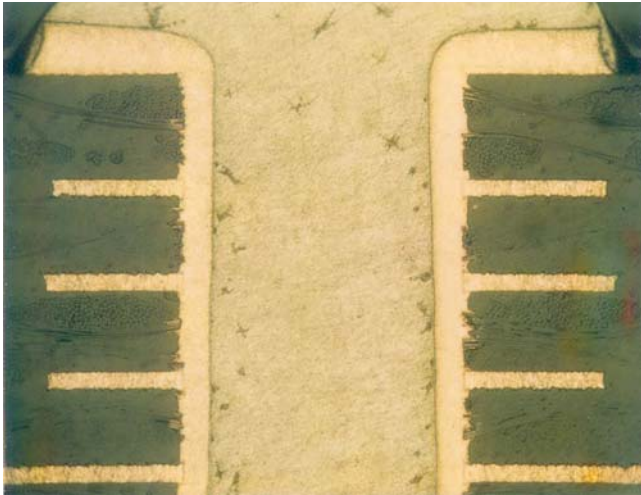

图337c

#### Target Condition - Class 1,2,3 (目标条件 - 1,2,3级)

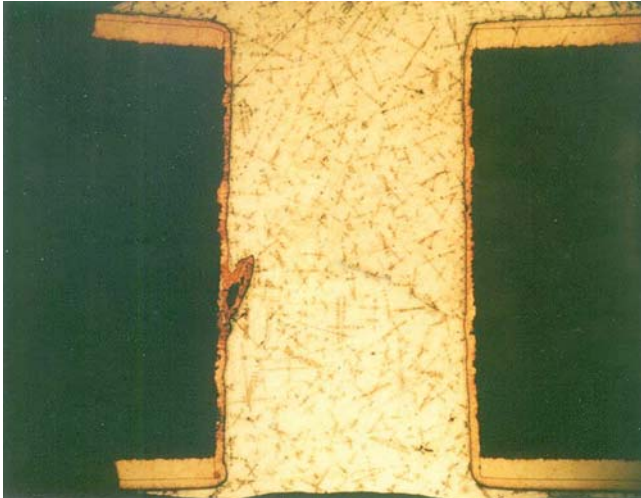
- Plating is smooth and uniform throughout the hole. No evidence of roughness or nodules.
- 整个孔壁镀层平滑而均匀。无粗糙或结瘤迹象。

#### Acceptable - Class 1,2,3 (可接受条件 - 1,2,3级)

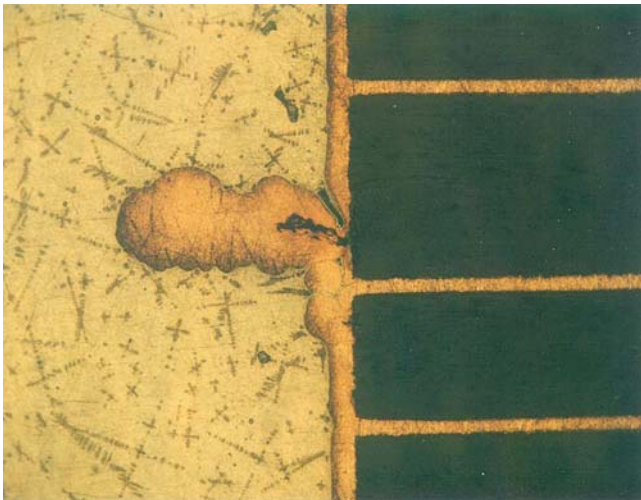
- Roughness or nodules do not reduce plating thickness below absolute minimum requirements or hole diameter below minimum requirements.
- 粗糙或结瘤没有使镀层厚度减小至低于绝对最小值且未使孔径低于最低要求。

#### Nonconforming - Class 1,2,3 (不符合条件 - 1,2,3级)

- Defects either do not meet or exceed above criteria.
- 缺陷不符合或超出上述要求。

Visual observations made on cross-sections only. (仅对显微切片进行目检观察。)



### 3.3.8 Copper Plating Thickness – Hole Wall (铜镀层厚度 – 孔壁)

The average copper thickness should be determined from three measurements, approximately equally spaced, on each side of the PTH. Do not measure in areas having isolated imperfections such as voids, cracks or nodules.

平均铜厚应该通过在镀覆孔每侧壁上大约等距离选取三个测试点所得的测量值确定。不要测量有孤立缺陷的区域，例如空洞、裂缝或结瘤等。



图338a

#### Target Condition - Class 1,2,3 (目标条件 - 1,2,3级)

- Plating is smooth and uniform throughout the hole. Plating thickness meets requirements.
- 整个孔壁镀层平滑而均匀。镀层厚度满足要求。

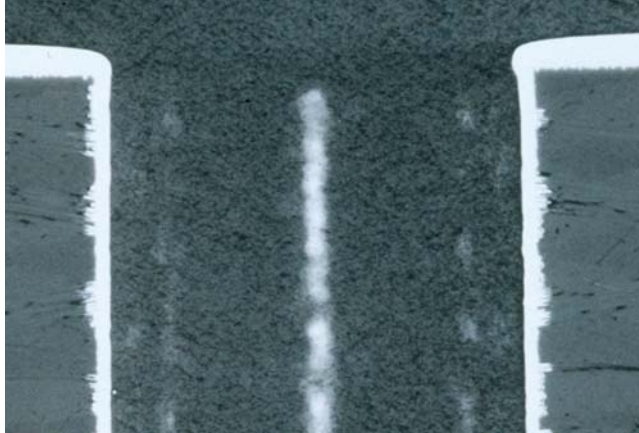

图338b

#### Acceptable - Class 1,2,3 (可接受条件 - 1,2,3级)

- Plating thickness varies but meets minimum average requirements and minimum thin area requirements in the IPC-6010 series.
- Small localized areas with plating thickness less than minimum requirement are evaluated as voids.
- 镀层厚度不均，但满足IPC 6010系列中规定的最低平均厚度要求和最薄区域厚度要求。
- 对于镀层厚度小于最小要求的局部小区域，按空洞对其进行评定。

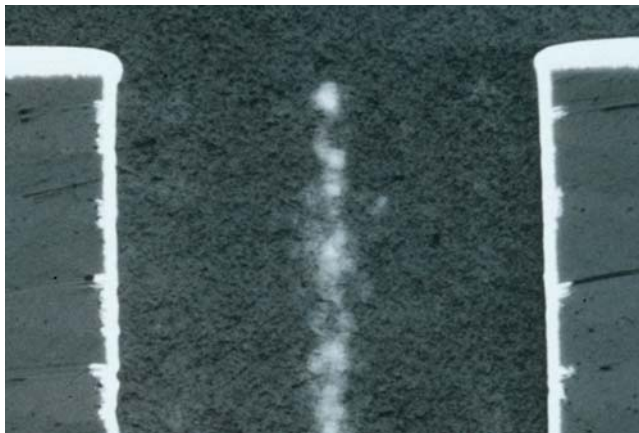

图338c

#### Nonconforming - Class 1,2,3 (不符合条件 - 1,2,3级)

- Defects either do not meet or exceed above criteria.
- 缺陷不符合或超出上述要求。

Visual observations made on cross-sections only. (仅对显微切片进行目检观察。)

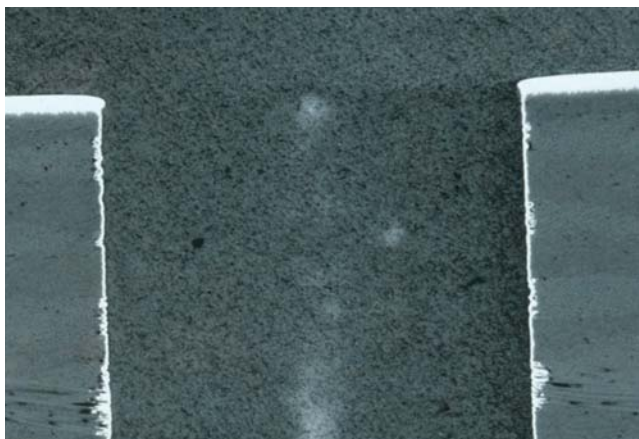

## 3.3.9 Copper Wrap Plating (铜包覆电镀)

Copper wrap plating minimum as specified in the IPC-6010 series **shall** be continuous from the filled plated hole onto the external surface of any plated structure and extend by a minimum of 25  $\mu\text{m}$  [984  $\mu\text{in}$ ] where an annular ring is required as shown in Figure 339a.

Reduction of surface wrap copper plating by processing (sanding, etching, planarization, etc.) resulting in insufficient wrap plating is not allowed as shown in Figure 339b.

IPC-6010系列文件中规定的最小铜包覆电镀**应当**从填塞的镀覆孔到任何电镀结构外表面是连续的, 且在要求有环宽时, 至少要延伸25 $\mu\text{m}$ [984 $\mu\text{in}$ ], 如图339a所示。

不允许出现如图339b所示的由于加工(研磨、蚀刻、整平等)导致包覆铜电镀不足造成的表面包覆铜镀层减少。



图339a 表面包覆铜测量 (适用于所有填塞的PTH)



图339b 由于过度研磨/整平去除的包覆铜 (不可接受)

注: 尺寸标注线和箭头标示出了包覆铜已被去除之处。

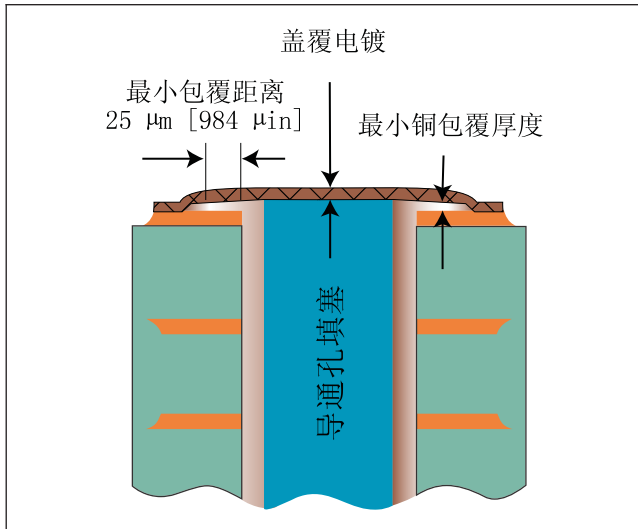
**Note:** Cap plating, if required, over filled holes is not considered in wrap copper thickness measurements.

注: 如要求盖覆电镀, 测量包覆铜厚度时, 不考虑将塞孔上方作为测量点。

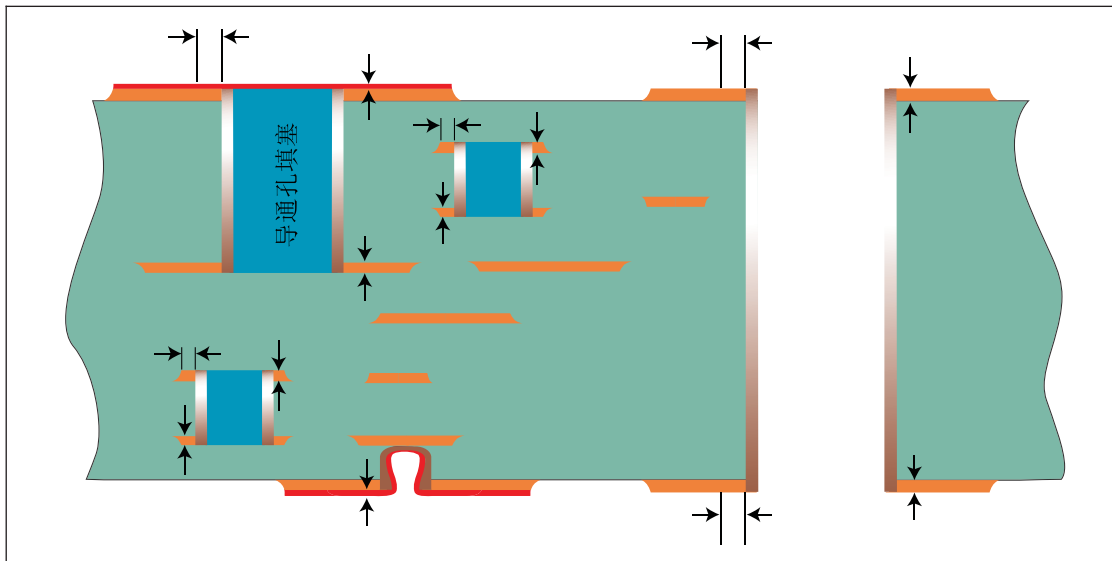
Visual observations made on cross-sections only. (仅对显微切片进行目检观察。)

## 3.3.9 Copper Wrap Plating (cont.) (包覆铜电镀 (续))



图339c

**Target Condition - Class 1,2,3 (目标条件 - 1,2,3级)****Acceptable - Class 3 (可接受条件 - 3级)**

- Wrap plating is continuous from the filled plated hole onto the external surface and extends by a minimum of 25  $\mu\text{m}$  [984  $\mu\text{in}$ ] where an annular ring is required.
- Wrap thickness is not less than 12  $\mu\text{m}$  [472  $\mu\text{in}$ ] for through, blind and buried vias  $\geq$  two layers..
- Wrap thickness is not less than 6  $\mu\text{m}$  [236  $\mu\text{in}$ ] for blind and buried microvias.
- Wrap thickness is not less than 7  $\mu\text{m}$  [276  $\mu\text{in}$ ] for buried via cores (two layers).
- Reduction of surface wrap copper plating by processing (sanding, etching, planarization, etc.) does not result in insufficient wrap plating.
- 包覆铜电镀从填满的镀覆孔到外层表面是连续的，且要求有环宽时，至少延伸25 $\mu\text{m}$ [984 $\mu\text{in}$ ]。
- 对于大于等于两层的通孔、盲导通孔和埋导通孔，包覆铜镀层厚度不小于12 $\mu\text{m}$ [472 $\mu\text{in}$ ]。
- 对于盲孔和埋孔微导通孔包覆铜镀层厚度不小于6 $\mu\text{m}$ [236 $\mu\text{in}$ ]。
- 对于埋孔导通孔芯材（两层）包覆铜镀层厚度不小于7 $\mu\text{m}$ [276 $\mu\text{in}$ ]。
- 由于加工（研磨、蚀刻、整平等）导致的表面包覆铜镀层的减少没有造成包覆铜镀层不足。

Visual observations made on cross-sections only. (仅对显微切片进行目检观察。)

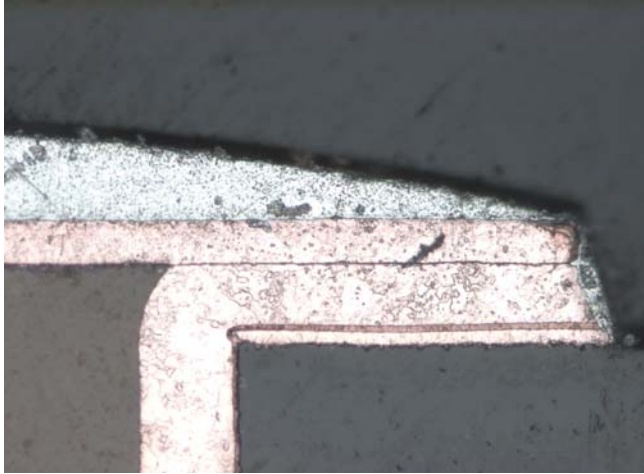
### 3.3.9 Copper Wrap Plating (cont.) (包覆铜电镀 (续))



图339d

#### Acceptable - Class 1,2 (可接受条件 - 1,2级)

- Wrap plating is continuous from the filled plated hole onto the external surface.
- Wrap thickness is not less than 5  $\mu\text{m}$  [197  $\mu\text{in}$ ] for all through-hole and via structures.
- Reduction of surface wrap copper plating by processing (sanding, etching, planarization, etc.) does not result in insufficient wrap plating.
- 包覆电镀从填塞的镀覆孔到外层表面是连续的。
- 对于所有通孔和导通孔结构，包覆铜镀层厚度不小于5 $\mu\text{m}$  [197 $\mu\text{in}$ ]。
- 由于加工（研磨、蚀刻、整平等）导致的表面包覆铜镀层的减少没有造成包覆铜镀层不足。

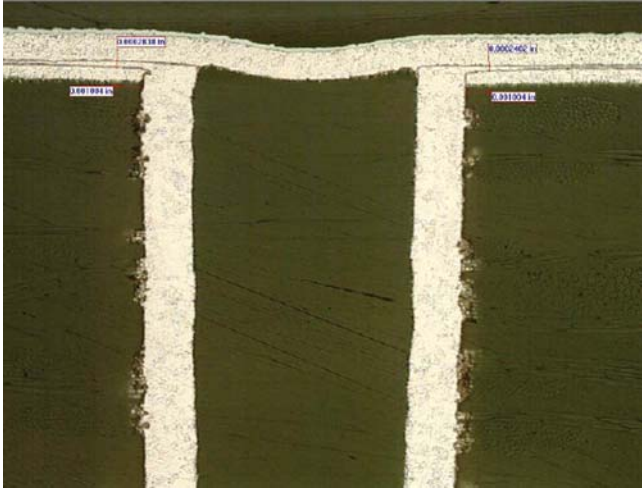

图339e

#### Nonconforming - Class 1,2,3 (不符合条件 - 1,2,3级)

- Defects either do not meet or exceed above criteria.
- 缺陷不符合或超出上述要求。

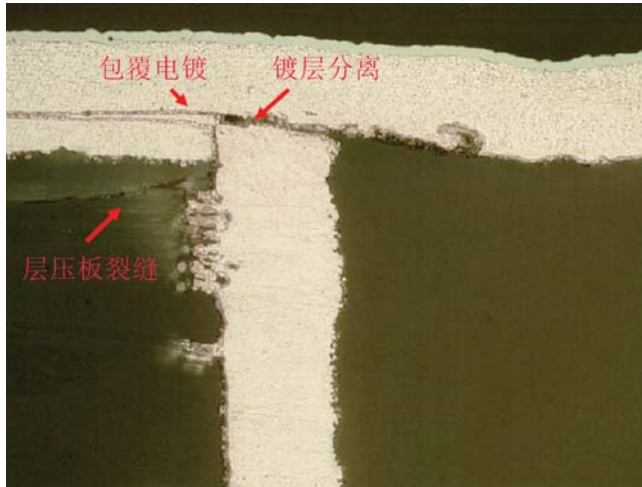

图339f

**Note:** Cap plating, if required, over filled holes is not considered in wrap copper thickness measurements.

**注:** 如要求盖覆电镀，测量包覆铜厚度时，不考虑将塞孔上方作为测量点。

Visual observations made on cross-sections only. (仅对显微切片进行目检观察。)

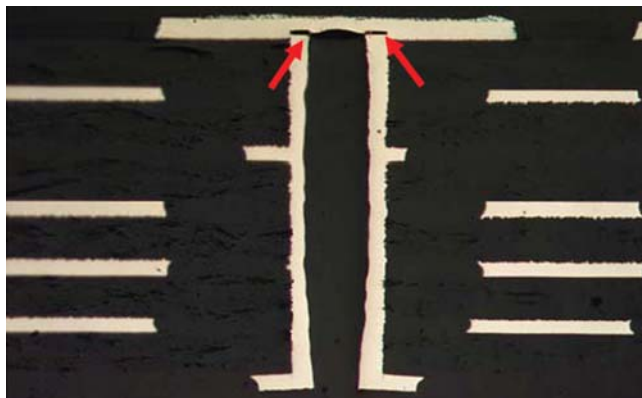
### 3.3.10 Plating Voids (镀层空洞)



图3310a

#### Target Condition - Class 1,2,3 (目标条件 - 1,2,3级)

- Hole is free of voids.
- 孔内无空洞。

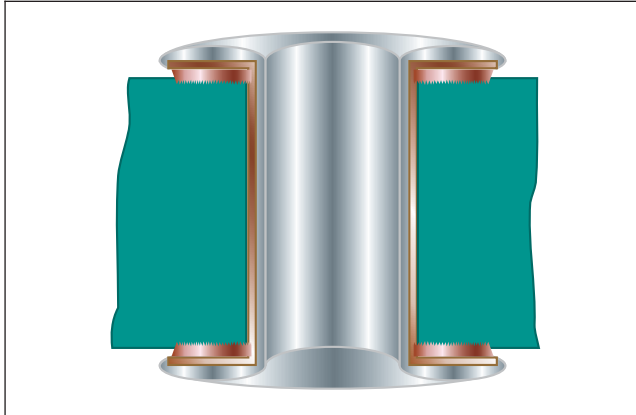

图3310b

#### Acceptable - Class 2,3 (可接受条件 - 2,3级)

- No more than one plating void per test coupon or production printed board, regardless of length or size.
- No plating void in excess of 5% of the total printed board thickness.
- No plating voids evident at the interface of an internal conductive layer and plated hole wall.
- Plating voids less than or equal to 90° of the circumference.
- 每块附连测试板或成品印制板上的镀层空洞不多于1个，无论长度或大小。
- 镀层空洞不超过印制板总厚度的5%。
- 在内层导电层与孔壁镀层的界面无镀层空洞。
- 镀层空洞小于或等于圆周的90°。

#### Acceptable - Class 1 (可接受条件 - 1级)

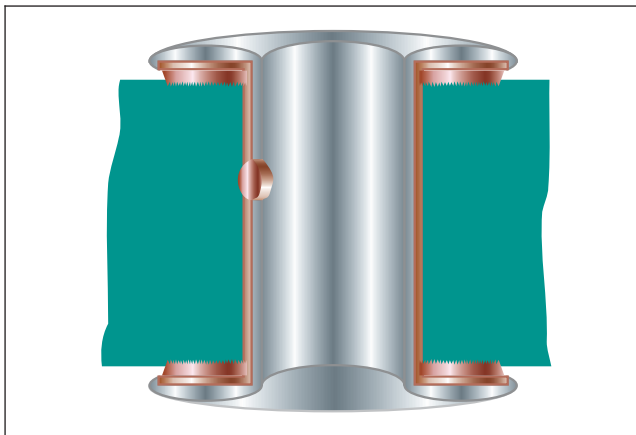
- No more than three plating void per test coupon or production printed board, regardless of length or size.
- No plating void in excess of 5% of the total printed board thickness.
- No plating voids evident at the interface of an internal conductive layer and plated hole wall.
- Plating voids less than or equal to 90° of the circumference.
- 每块附连测试板或成品印制板上的镀层空洞不多于3个，无论长度或大小。
- 镀层空洞未超过印制板总厚度的5%。
- 在内层导电层与孔壁镀层的界面无镀层空洞。
- 镀层空洞小于或等于圆周的90°。

Visual observations made on cross-sections only. (仅对显微切片进行目检观察。)

### 3.3.10 Plating Voids (镀层空洞) (续)



图3310c

#### Nonconforming - Class 1,2,3 (不符合条件 - 1,2,3级)

- Defects either do not meet or exceed above criteria.
- 缺陷不符合或超出上述要求。

Visual observations made on cross-sections only. (仅对显微切片进行目检观察。)

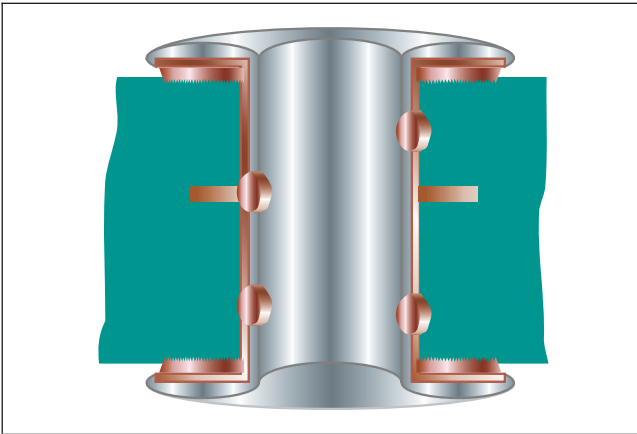

3.3.11 Solder Coating Thickness (Only When Specified) (焊料涂覆层厚度 (仅当有规定时))

Solder coating thickness, when specified, shall be evaluated prior to thermal stress.

当焊料涂覆层厚度有规定时，应当在热应力测试之前做评定。



图3311a

**Target Condition - Class 1,2,3 (目标条件 - 1,2,3级)**

- Solder coating thickness is uniform and covers etched land edge. Exposed copper is not evident.
- 焊料涂覆层厚度均匀并覆盖已蚀刻的焊盘边缘。没有明显露铜。

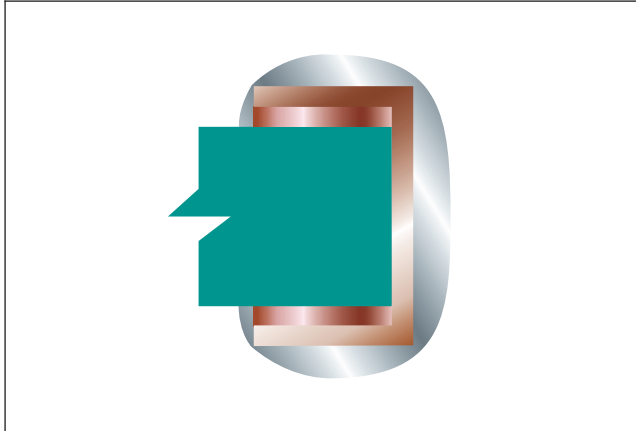

图3311b

**Acceptable - Class 1,2,3 (可接受条件 - 1,2,3级)**

- Solder coating thickness is uniform. Vertical (conductor and land) areas may not be covered. No exposed copper is evident.
- 焊料涂覆层厚度均匀，但垂直面（导体及焊盘）可以未被覆盖。没有明显露铜。

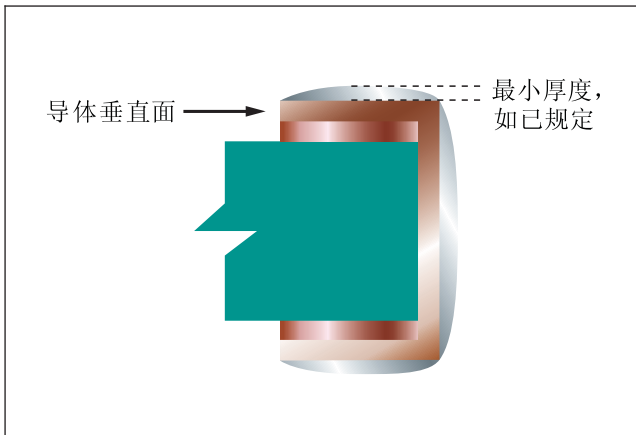

图3311c

**Nonconforming - Class 1,2,3 (不符合条件 - 1,2,3级)**

- Defects either do not meet or exceed above criteria.
- 缺陷不符合或超出上述要求。

**Note:** For solderability requirements, see 5.1.

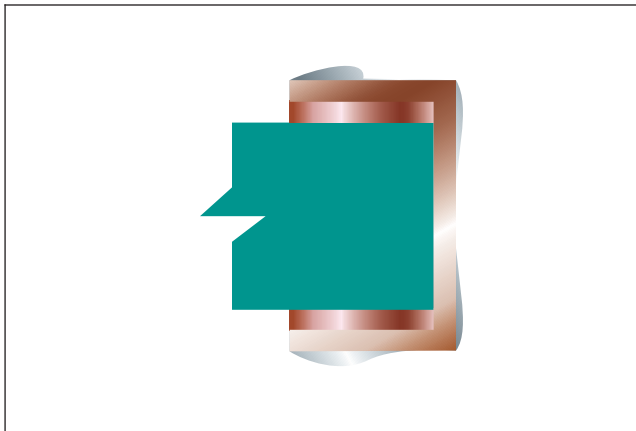
**注:** 对于可焊性要求，见5.1节。

Visual observations made on cross-sections only. (仅对显微切片进行目检观察。)

### 3.3.12 Solder Mask Thickness (阻焊膜厚度)



图3312a

**Target Condition - Class 1,2,3 (目标条件 - 1,2,3级)**

- Thickness as specified on procurement documentation.
- 厚度符合采购文件的规定。

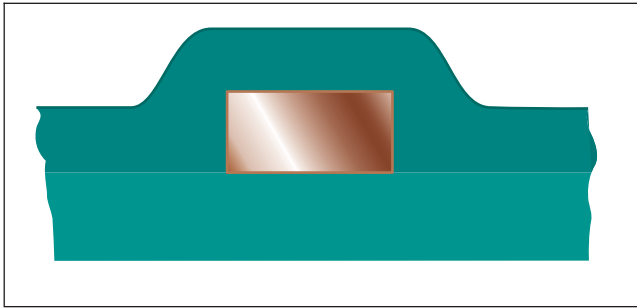

图3312b

**Acceptable - Class 1,2,3 (可接受条件 - 1,2,3级)**

- Specified: The solder mask thickness meets the thickness requirements on the procurement documentation (cannot be visually assessed).
- 有规定时: 阻焊膜厚度满足采购文件的厚度要求 (不能通过目检评定)。

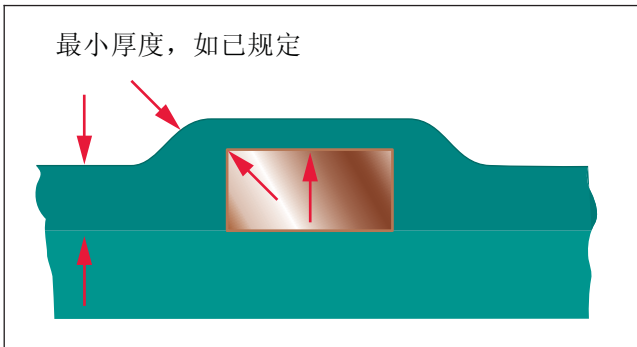

图3312c

**Nonconforming - Class 1,2,3 (不符合条件 - 1,2,3级)**

- Defects either do not meet or exceed above criteria.
- 缺陷不符合或超出上述要求。

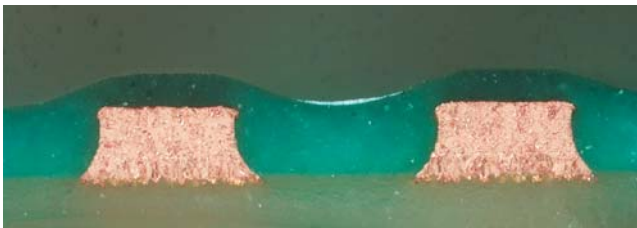

图3312d



图3312e

Visual observations made on cross-sections only. (仅对显微切片进行目检观察。)

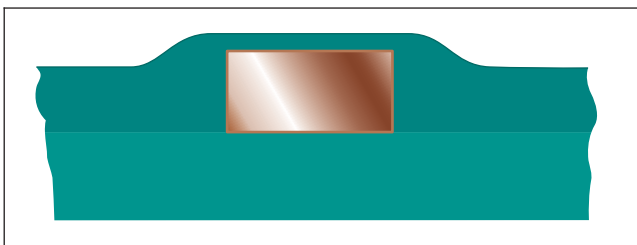
### 3.3.13 Wicking (芯吸)

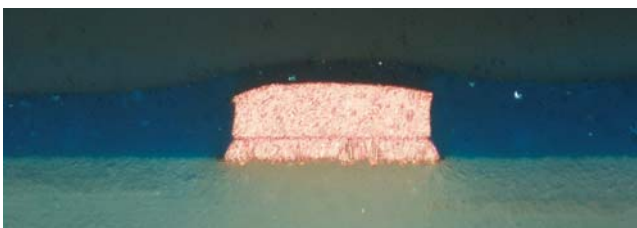

图3313a

**Target Condition - Class 1,2,3 (目标条件 - 1,2,3级)**

- No wicking present.
- 没有出现芯吸。

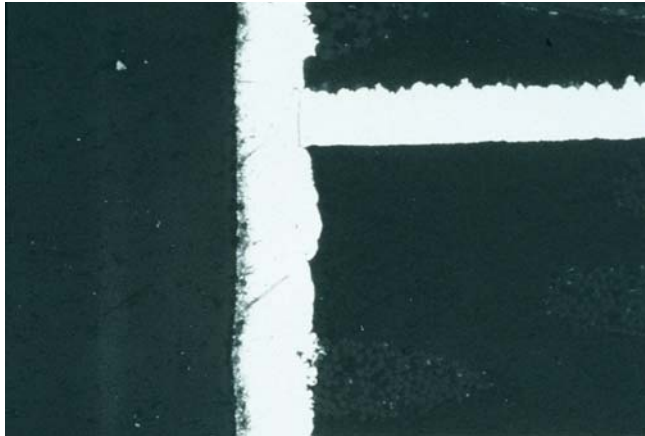

图3313b

**Acceptable - Class 3 (可接受条件 - 3级)**

- Wicking does not exceed  $80\ \mu\text{m}$  [ $3,150\ \mu\text{in}$ ].
- 芯吸未超过 $80\ \mu\text{m}$ [ $3,150\ \mu\text{in}$ ]。

**Acceptable - Class 2 (可接受条件 - 2级)**

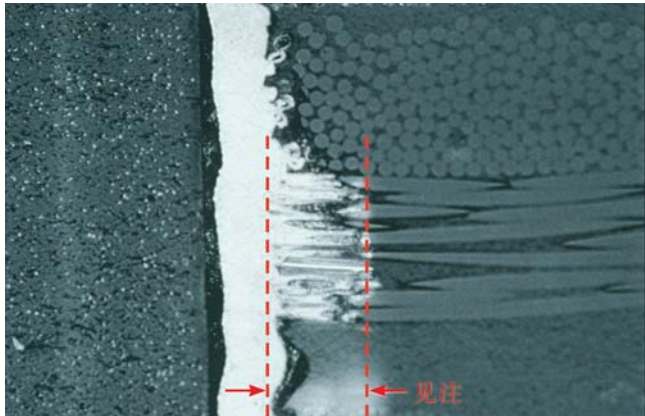
- Wicking does not exceed  $100\ \mu\text{m}$  [ $3,937\ \mu\text{in}$ ].
- 芯吸未超过 $100\ \mu\text{m}$ [ $3,937\ \mu\text{in}$ ]。

**Acceptable - Class 1 (可接受条件 - 1级)**

- Wicking does not exceed  $125\ \mu\text{m}$  [ $4,921\ \mu\text{in}$ ].
- 芯吸未超过 $125\ \mu\text{m}$ [ $4,291\ \mu\text{in}$ ]。



图3313c

**Nonconforming - Class 1,2,3 (不符合条件 - 1,2,3级)**

- Defects either do not meet or exceed above criteria.
- 缺陷不符合或超出上述要求。

**Note:** Wicking is measured from the laminate edge excluding the plating.

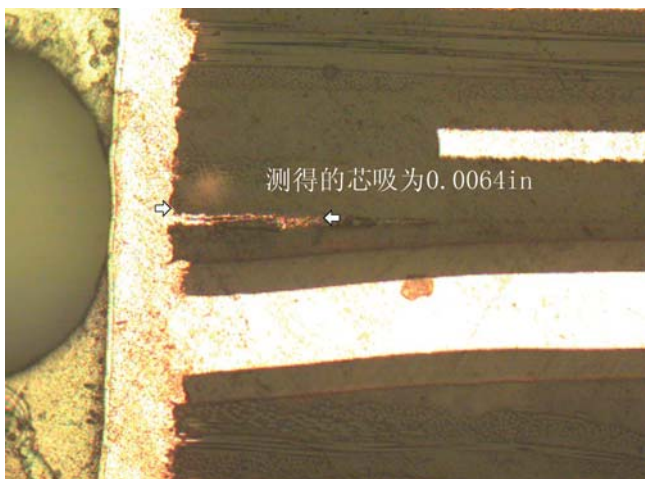
**注:** 芯吸的测量从层压板边缘量起, 镀层不包括在内。

Visual observations made on cross-sections only. (仅对显微切片进行目检观察。)

### 3.3.13.1 Wicking, Clearance Holes (隔离孔的芯吸)



图33131a

A) 表面焊盘  
B) 介质  
C) 相邻的非公共导体  
D) 表面镀层



图33131b

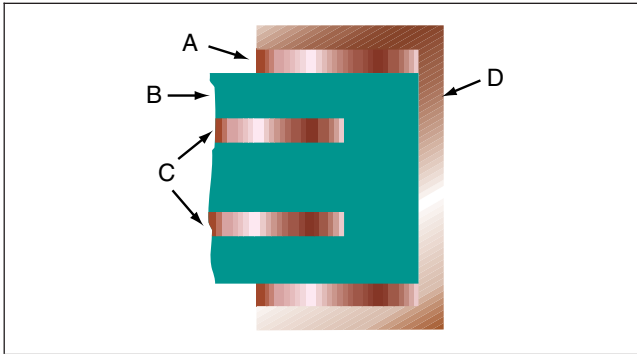

图33131c

#### Target Condition - Class 1,2,3 (目标条件 - 1,2,3级)

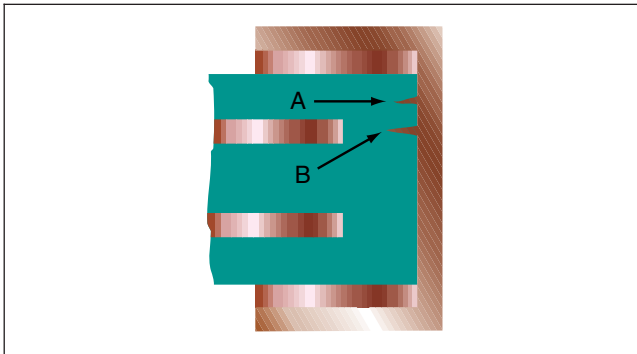
- No wicking of conductive material into base material or along the reinforcement material.
- 没有导电材料渗入基材或沿着增强材料渗入的芯吸。

#### Acceptable - Class 3 (可接受条件 - 3级)

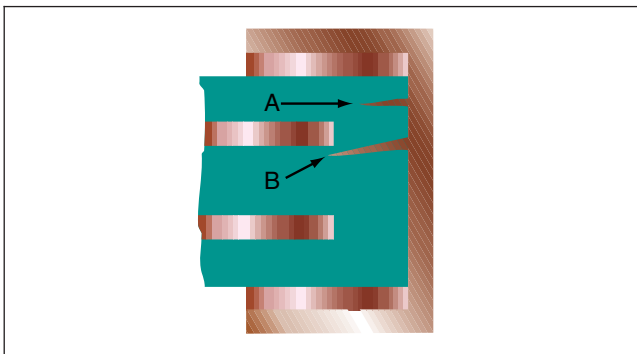
- Wicking (A) does not exceed 80  $\mu\text{m}$  [3,150  $\mu\text{in}$ ]
- Wicking (B) does not reduce conductor spacing less than specified minimum on the procurement documentation.
- 芯吸 (A) 未超过80 $\mu\text{m}$ [3,150 $\mu\text{in}$ ]
- 芯吸 (B) 没有使间距减少至低于采购文件规定的最小值。

#### Acceptable - Class 2 (可接受条件 - 2级)

- Wicking (A) does not exceed 100  $\mu\text{m}$  [3,937  $\mu\text{in}$ ]
- Wicking (B) does not reduce conductor spacing less than specified minimum on the procurement documentation.
- 芯吸 (A) 未超过100 $\mu\text{m}$ [3,937 $\mu\text{in}$ ]
- 芯吸 (B) 没有使间距减少至低于采购文件规定的最小值。

#### Acceptable - Class 1 (可接受条件 - 1级)

- Wicking (A) does not exceed 125  $\mu\text{m}$  [4,921  $\mu\text{in}$ ]
- Wicking (B) does not reduce conductor spacing less than specified minimum on the procurement documentation.
- 芯吸 (A) 未超过125 $\mu\text{m}$ [4,921 $\mu\text{in}$ ]
- 芯吸 (B) 没有使间距减少至低于采购文件规定的最小值。

#### Nonconforming - Class 1,2,3 (不符合条件 - 1,2,3级)

- Defects either do not meet or exceed above criteria.
- 缺陷不符合或超出上述要求。

Visual observations made on cross-sections only. (仅对显微切片进行目检观察。)

3.3.14 Innerlayer Separation – Vertical (Axial) Microsection (内层分离 – 垂直 (轴向) 显微切片)



图3314a



图3314b

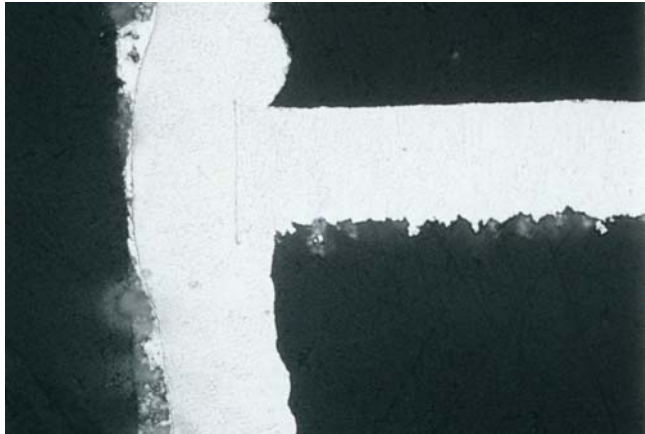

图3314c

**Target Condition - Class 1,2,3 (目标条件 - 1,2,3级)**

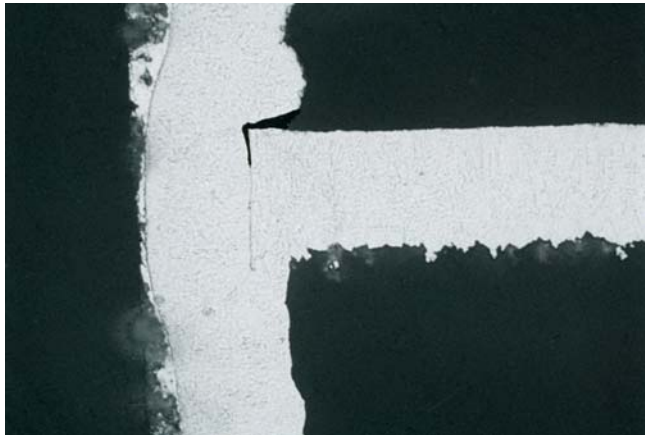
- Direct bond of plated copper to copper foil. No evidence of inner-layer separation (separation between internal lands and plating of the hole wall) or innerlayer inclusions.
- 镀铜层与铜箔直接接合，不存在内层分离（内层连接盘与孔壁镀层间的分离）或内层夹杂物。

**Acceptable - Class 2,3 (可接受条件 - 2,3级)**

- No separation evident.
- 没有分离迹象。

**Acceptable - Class 1 (可接受条件 - 1级)**

- Partial innerlayer separation or innerlayer inclusions on only one side of hole wall at each land location on no more than 20% of each available land.
- 对于每个待钻孔焊盘，在不超过焊盘20%的范围内，只在孔壁的一侧出现内层部分分离或内层夹杂物。

**Nonconforming - Class 1,2,3 (不符合条件 - 1,2,3级)**

- Defects either do not meet or exceed above criteria.
- 缺陷不符合或超出上述要求。

Visual observations made on cross-sections only. (仅对显微切片进行目检观察。)



3.3.15 Innerlayer Separation – Horizontal (Transverse) Microsection (内层分离 – 水平 (横向) 显微切片)



图3315a



图3315b

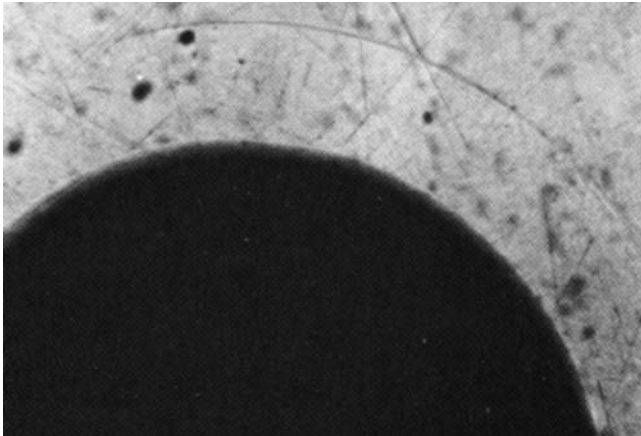

图3315c

**Target Condition - Class 1,2,3 (目标条件 - 1,2,3级)**

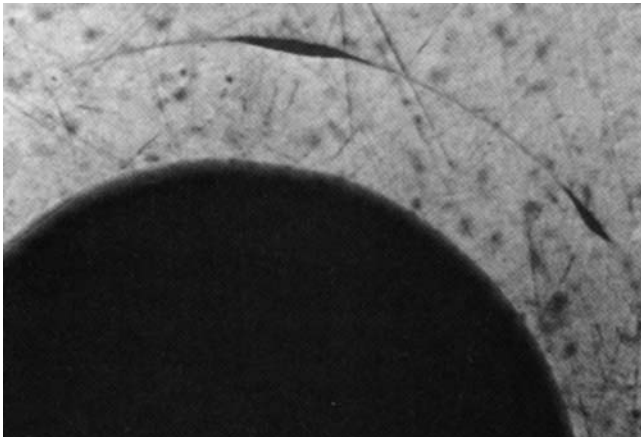
- No separation between the internal layer and plating in the hole. Direct bond of plated copper to layer foil copper. Line of demarcation caused by preferential etching of electroless copper deposit.
- 孔中内层铜箔与镀层之间没有分离。镀层与内层铜箔直接结合，两者之间的分界线是由于化学镀铜优先蚀刻而形成的。

**Acceptable - Class 2,3 (可接受条件 - 2,3级)**

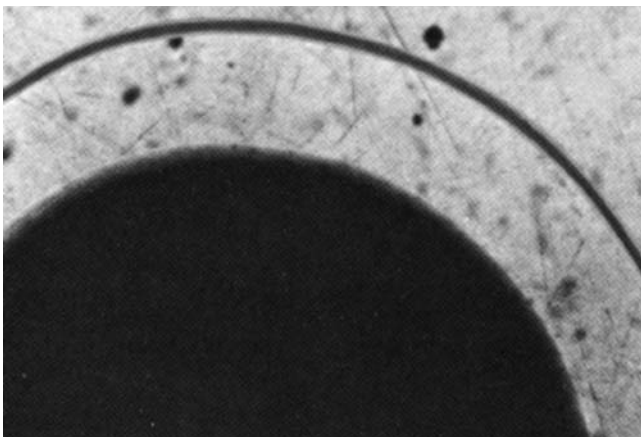
- No separation evident.
- 没有分离迹象。

**Acceptable - Class 1 (可接受条件 - 1级)**

- Slight line of demarcation and localized minor innerlayer separation that does not exceed specified requirements.
- 存在轻微的分界线并有轻微的局部内层分离，但尚未超过规定的要求。

**Nonconforming - Class 1,2,3 (不符合条件 - 1,2,3级)**

- Defects either do not meet or exceed above criteria.
- 缺陷不符合或超出上述要求。

Visual observations made on cross-sections only. (仅对显微切片进行目检观察。)

### 3.3.16 Material Fill of Blind and Buried Vias (埋/盲导通孔的材料填塞)

Blind via holes should be filled or plugged with a polymer or solder mask to prevent solder from entering them as solder in the small holes tends to decrease reliability. Incomplete via fill may result in printed board delamination due to the rapid expansion of entrapped air pockets or flux contaminants during solder reflow processes. Requirements for buried via fill are listed below.

盲导通孔应该用聚合物或阻焊剂填充或填塞以防止焊料进入，因为小孔内有焊料容易降低可靠性。孔未填满时，在再流焊过程中，夹带的空气或助焊剂污染物会迅速膨胀而导致印制板分层。埋导通孔的填塞要求如下：



图3316a



图3316b

#### Target - Class 1,2,3 (目标条件 - 1,2,3级)

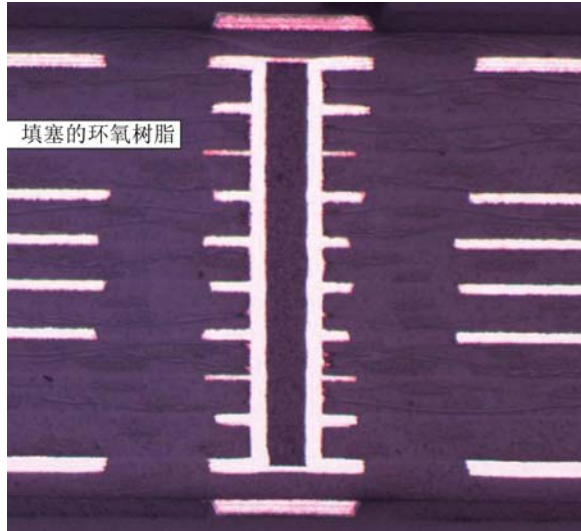
- Complete fill of blind or buried via with laminating resin or similar fill material.
- 盲/埋导通孔完全填满层压树脂或类似填塞材料。

#### Acceptable - Class 1,2,3 (可接受条件 - 1,2,3级)

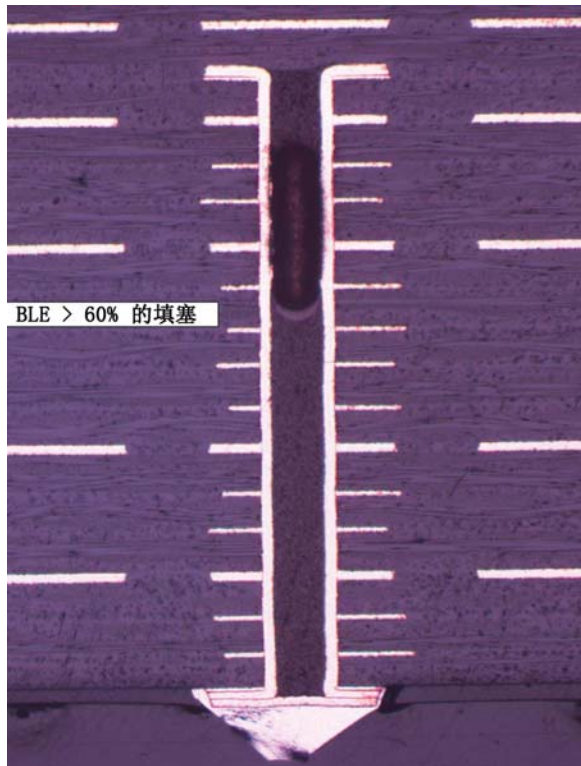
- At least 60% buried via fill with laminating resin or similar fill material.
- 层压树脂或类似填充材料至少填塞了埋导通孔的60%。

#### Acceptable - Class 2,3 (可接受条件 - 2,3级)

- At least 60% fill for blind vias with an aspect ratio greater than 1:1 or as specified in the procurement documentation.
- 厚径比大于1:1的盲导通孔至少被填塞了60%或符合采购文件规定。

**Note:** Through hole fill requirements are AABUS.

**注:** 通孔的填塞要求由供需双方协商确定。

Visual observations made on cross-sections only. (仅对显微切片进行目检观察。)

### 3.3.16 Material Fill of Blind and Buried Vias (cont.) (埋/盲导通孔的材料填塞 (续))

**Acceptable - Class 1 (可接受条件 - 1级)**

- Buried vias completely void of fill material.
- 埋导通孔中完全没有填塞材料。

**Nonconforming - Class 1,2,3 (不符合条件 - 1,2,3级)**

- Defects either do not meet or exceed above criteria.
- 缺陷不符合或超出上述要求。



图3316c

**Note:** Through hole fill requirements are AABUS.

**注:** 通孔的填塞要求由供需双方协商确定。

Visual observations made on cross-sections only. (仅对显微切片进行目检观察。)

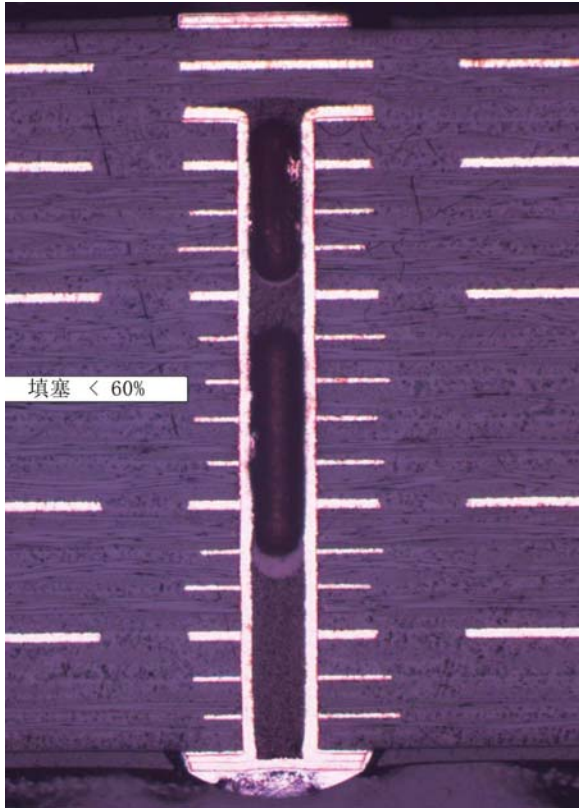
### 3.3.17 Cap Plating of Filled Holes (填塞孔的盖覆电镀)

When copper cap plating of filled holes is specified by the master drawing the following **shall** apply.

当布设总图规定用铜盖覆电镀填塞孔时，应当采用以下要求。



图3317a

#### Target Condition - Class 1,2,3 (目标条件 - 1,2,3级)

- Copper surface is planar with no protrusion (bump) and/or depression (dimple)
- 铜表面平整，无凸起（凸块）和凹陷（凹坑）。

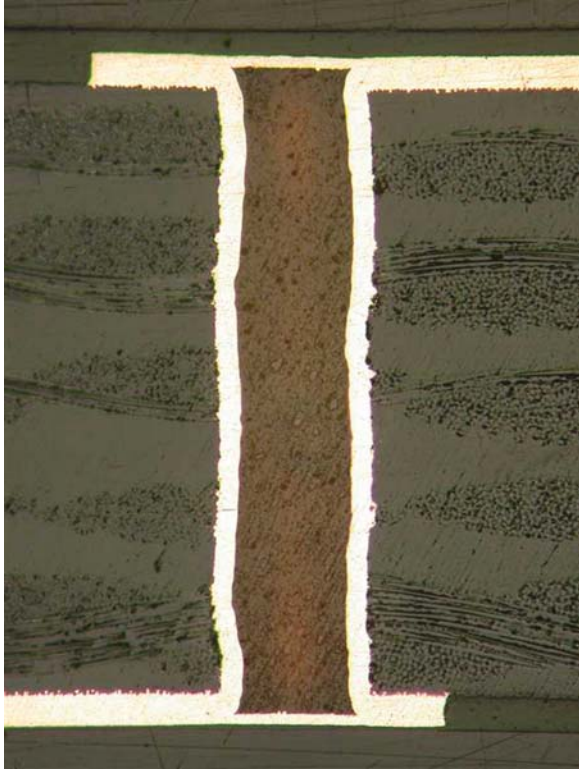

图3317b

#### Acceptable - Class 1,2,3 (可接受条件 - 1,2,3级)

- Separation of copper cap to fill material.
- No separation of the cap plating to underlying plating.
- Cap protrusion (bump) and/or depression (dimple) meets the dimensional requirements in IPC-6012.
- Fill material within the blind via **shall** be planar with the surface within  $\pm 0.076 \text{ mm}$  [0.003 in] unless otherwise specified.
- When cap plating is specified, fill material within the blind via **shall** meet the dimple/bump requirements of IPC-6012.
- No voids in the cap plating over the resin fill.
- 允许铜盖覆层与孔填充材料的分离。
- 盖覆镀层与底层镀层没有分离。
- 盖覆的凸起（凸块）和凹陷（凹坑）满足IPC-6012中的尺寸要求。
- 除非另有规定，盲导通孔内的填充材料与表面的平整度应当在  $\pm 0.076 \text{ mm}$  [0.003 in] 以内。
- 当规定盖覆电镀时，盲孔内的填充材料应当满足IPC-6012中的凹陷和凸起要求。
- 填充树脂上的盖覆镀层无空洞。

Visual observations made on cross-sections only. (仅对显微切片进行目检观察。)

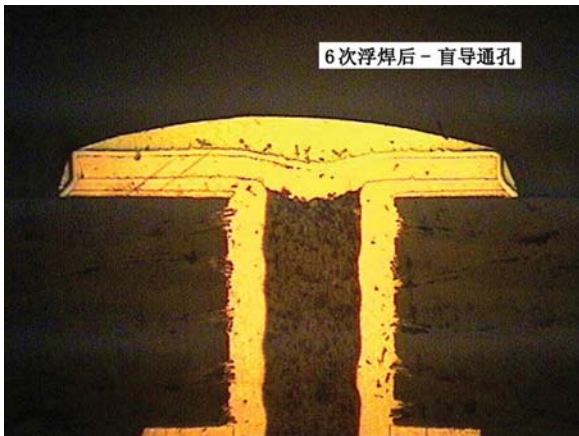

3.3.17 Cap Plating of Filled Holes (cont.) (填塞孔的盖覆电镀 (续))



图3317c

**Nonconforming - Class 1,2,3 (不符合条件 - 1, 2, 3级)**

- Defects either do not meet or exceed above criteria.
- 缺陷不符合或超出上述要求。

Visual observations made on cross-sections only. (仅对显微切片进行目检观察。)

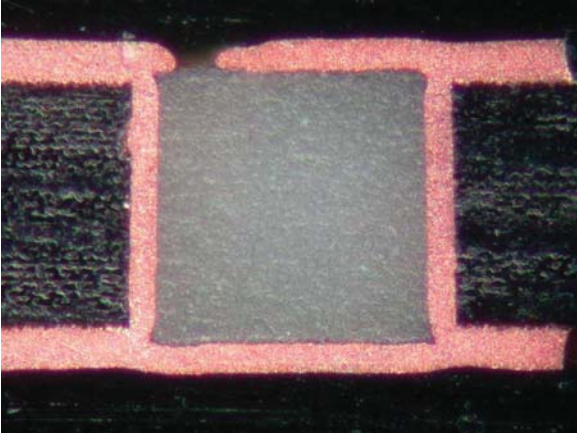

## Introduction (引言)

This section identifies the acceptability characteristics for drilled PTHs. Although only two characteristics are identified (burrs and nailheading), good drilling is essential for a good PTH. The drilled hole wall should be smooth and free of burrs, delamination, burning, crushed insulation, and protruding fibers. The hole should be perpendicular, round and not tapered. A poorly drilled hole may cause other problems that have been described and characterized in other sections of this document. These problems are:

- Rough plating
- Nodules
- Plating voids
- Thin plating
- Plating cracks (hole wall, corner)
- Wicking (excessive)
- Hole size reduction
- Pink ring
- Blow holes in soldering
- Skip plating

The physical appearance of a particular hole will be affected by one or more of the following variables:

- Drill point angle
- Drill rotation speed
- Drill feed rate
- Drill sharpness

Nailheading is a condition which may develop during the drilling operation. Worn drills, improper speeds and feeds, and/or soft back up and entry materials usually cause nailheading. The condition is acceptable for all classes.

本节旨在说明钻孔镀覆孔的可接受特性。虽然仅规定了两种特性（毛刺和钉头），但良好的钻孔是优质镀覆孔的关键。钻孔的孔壁应该平滑且没有毛刺、分层、烧焦、破碎绝缘物及突出的纤维等。孔应该垂直、圆而非锥形。差的钻孔可能引起的其它许多问题，这些已经在本文件的其它章节中进行了描述与说明。这些问题是：

- 镀层粗糙
- 结瘤
- 镀层空洞
- 镀层过薄
- 镀层裂缝（孔壁、拐角）
- 芯吸（过度）
- 孔径减小
- 粉红环
- 焊接时出现气孔
- 跳镀

个别孔的物理外观会受以下一项或多项变量的影响：

- 钻尖角度；
- 钻头转速；
- 钻头进给速率；
- 钻头锐利度。

钉头是钻孔过程中可能产生的一种状况。钉头通常是由于钻头磨损、不适当的转速及进给速率，和（或）软的垫板、盖板材料等造成的。这种情况对所有级别产品均是可接受的。

### 3.4.1 Burrs (毛刺)



图341a

#### Target Condition - Class 1,2,3 (目标条件 - 1,2,3级)

- No evidence of burrs.
- 没有毛刺迹象。



图341b

#### Acceptable - Class 1,2,3 (可接受条件 - 1,2,3级)

- Burrs are acceptable for all classes provided they do not reduce hole diameter or plating thickness below required minimums.
- 只要没有使孔径或镀层厚度减小至低于要求的最小值，则毛刺对于所有级别产品均是可接受的。

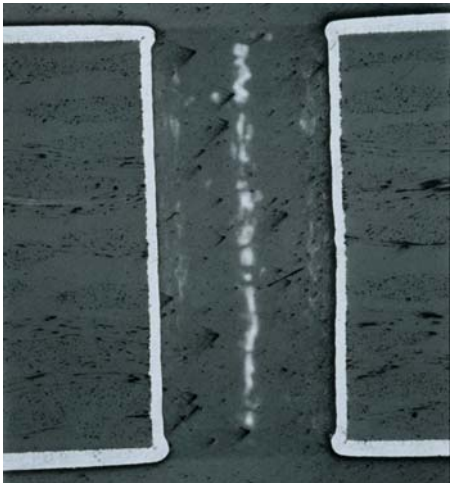

图341c

#### Nonconforming - Class 1,2,3 (不符合条件 - 1,2,3级)

- Defects either do not meet or exceed above criteria.
- 缺陷不符合或超出上述要求。

Visual observations made on cross-sections only. (仅对显微切片进行目检观察。)

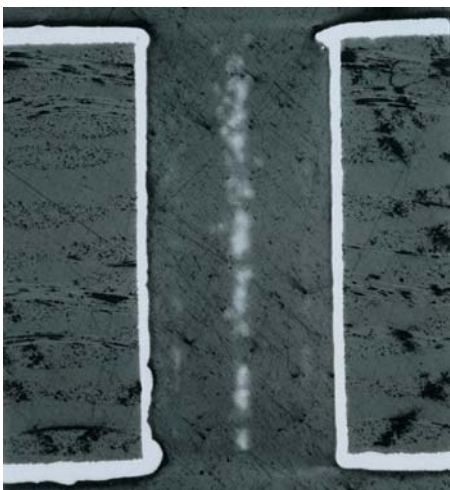
### 3.4.2 Nailheading (钉头)

No evidence exists that nail heading affects functionality. The presence of nail heading may be considered an indicator of process or design variation but is not a cause for rejection. Consider evaluation for glass bundle damage.

没有证据表明钉头会影响功能。钉头的出现可视为制程警示或设计变异,但不能作为拒收的理由。可考虑评估玻璃纤维束的损伤。



图342a



图342b

Visual observations made on cross-sections only. (仅对显微切片进行目检观察。)

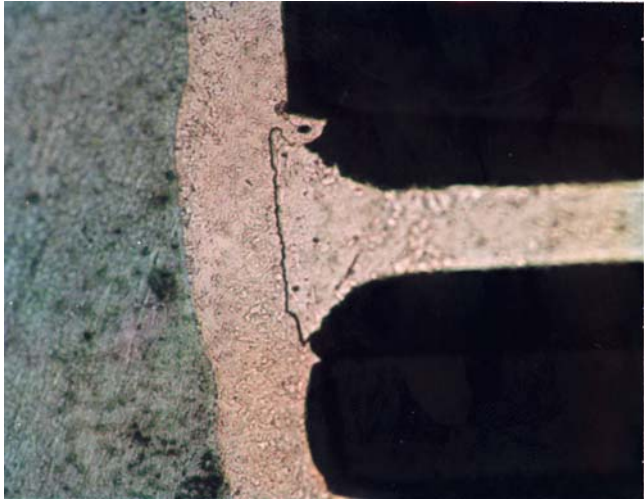
## Introduction (引言)

The figures below depict a punched hole and a punched and plated hole in a reinforced laminate. The figures show the characteristics which may be exhibited in a punched hole. Punched holes may appear different than drilled holes. Drilled holes have straight wall geometry while the geometry of punched holes will vary from straight to those seen in the figures. The difference in the hole characteristics are attributed to:

- Laminate type and thickness
- Design of punch and die
- Processing techniques
- Thickness and type of cladding
- Tool maintenance

The laminate type is very important in determining its punchability. Laminates in which all the base material is woven fabric are difficult to punch. The composite materials utilizing a woven fabric top and bottom sheet and a random fiber internal mat are easily punched and the straight wall geometry of the drilled hole can be approached. Punch and die clearance and sharpness are also important when a straight wall is desired and a small flare is required. The amount of flare, foil burr, foil intrusion, laminate bulge, and laminate rollover seen in the figures do not necessarily degrade the plated-through hole quality and are acceptable for all classes provided other requirements are in compliance with the performance specifications and the engineering description.

下面各图所示为增强层压板上的冲孔及冲孔镀覆孔的情况。示意图图示了冲孔中可能呈现的特征。冲孔外观可能不同于钻孔。钻孔孔壁具有垂直的几何形状，而冲孔的外形会出现从笔直的孔壁到类似于附图中所看到的各种变化。导致冲孔呈现不同特征归因于：

- 层压板的类型及厚度；
- 冲头及冲模的设计；
- 加工技术。
- 覆铜箔的厚度及类型；
- 工具的维护；

层压板的类型是决定可冲性的非常重要的因素。基材全是编织型玻璃布的层压板很难进行冲孔。用玻璃布作为上、下面而中间夹入不规则玻璃纤维毡组成的复合板则易于冲孔，同时也能得到近似钻孔那样的笔直的孔壁。当期望得到笔直孔壁及较小锥口时，冲头与冲模的间隙以及其锐利性也是很重要的。冲孔后出现如图中的锥口、铜箔毛刺、铜箔挤入、基板凸出、基板卷边等缺陷，只要板子其它方面都符合性能规范与工程说明的要求，且其缺陷又没有降低镀覆孔的品质时，则对于所有级别产品均是可接受的。



图35a 冲孔



图35b 冲孔镀覆孔

Although burrs and fibers can also be associated with the straight wall geometry of a drilled hole, the concepts of flare and intrusion relate specifically to punched hole formation techniques. An intrusion of copper foil within the punched hole can result from excessive punch-to-die clearance or a dull punch. Tapered flare or breakout is a normal condition on the exit side of a punched hole and may be caused by the stress generated within the laminate during hole formation. The degree of flare can be controlled through variations in punch-to-die clearance and other operating parameters.

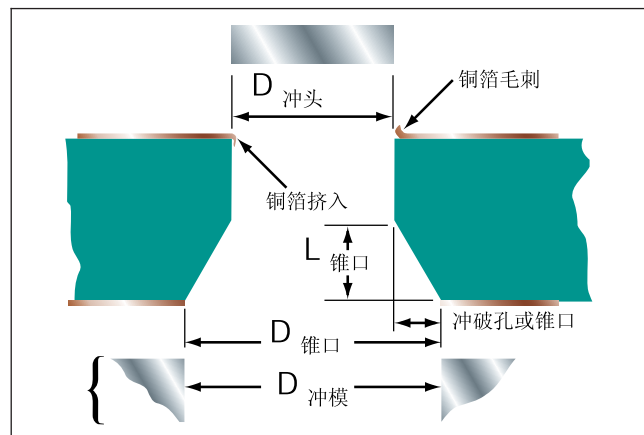
尽管钻孔的直壁上也会出现毛刺与玻璃纤维，但锥口及铜箔卷入则特别与冲孔成形技术有关。冲孔中铜箔卷入可能归因于冲头与冲模之间的间隙过大或冲头太钝。另外冲制孔在出口端呈锥形或破孔都是正常现象，其原因可能是孔成形时在板材内产生应力所造成。锥口的程度可以通过改变冲头与冲模的间隙及其它加工参数加以控制。

Visual observations made on cross-sections only. (仅对显微切片进行目检观察。)

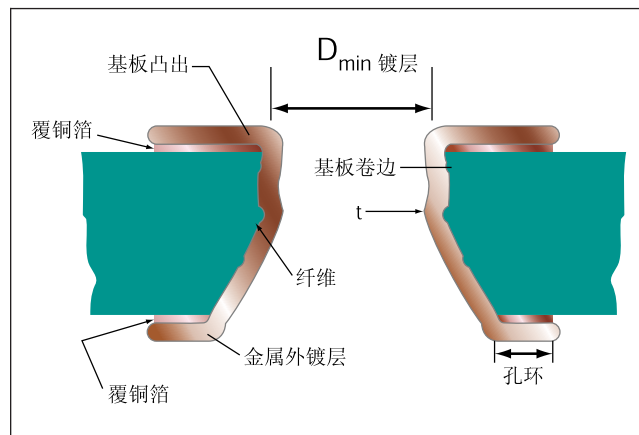
### 3.5.1 Roughness and Nodules (粗糙度和结瘤)



图351a

#### Target Condition - Class 1,2,3 (目标条件 - 1,2,3级)

- Plating is smooth and uniform throughout the hole. No evidence of roughness or nodules.
- 整个孔的镀层平滑而均匀。没有粗糙或结瘤迹象。

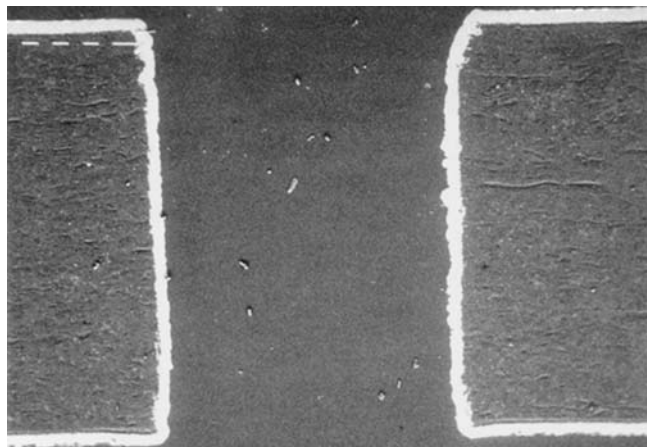

图351b

#### Acceptable - Class 1,2,3 (可接受条件 - 1,2,3级)

- Roughness or nodules do not reduce plating thickness or hole diameter below minimum requirements.
- 粗糙或结瘤没有使镀层厚度或孔径减小至低于最小要求。

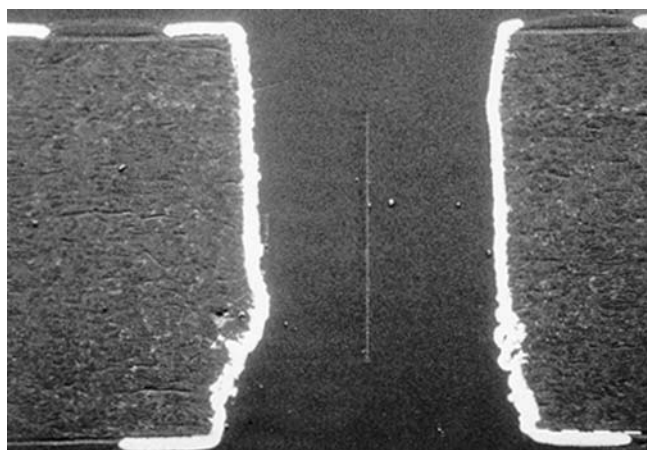

图351c

#### Nonconforming - Class 1,2,3 (不符合条件 - 1,2,3级)

- Defects either do not meet or exceed above criteria.
- 缺陷不符合或超出上述要求。

Visual observations made on cross-sections only. (仅对显微切片进行目检观察。)

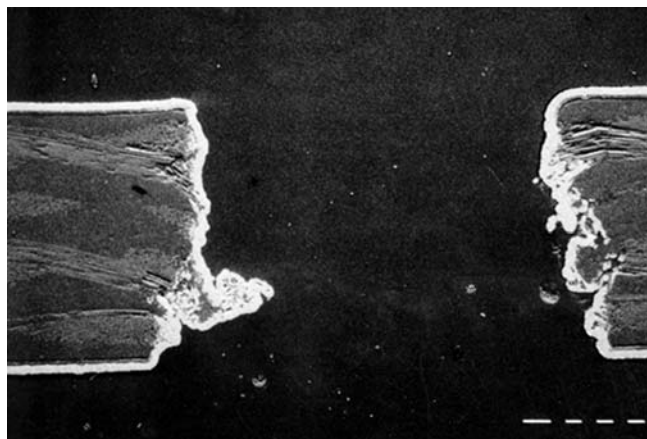

### 3.5.2 Flare (锥口)



图352a

**Target Condition - Class 1,2,3 (目标条件 - 1,2,3级)**

- Hole exhibits only slight flare and does not violate minimum annular ring requirements.
- 孔仅呈现轻微的锥口且未违反最小环宽要求。

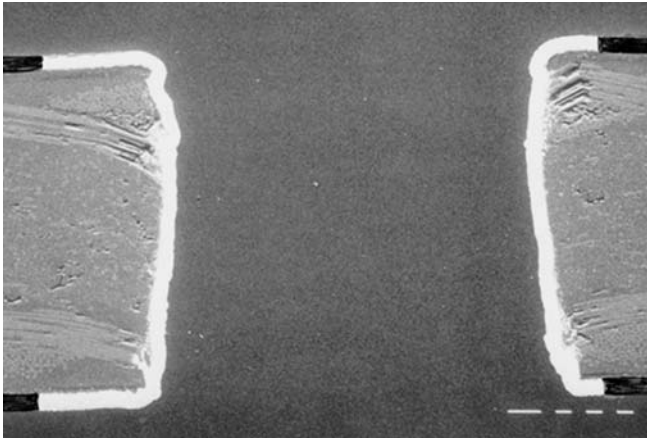

图352b

**Acceptable - Class 1,2,3 (可接受条件 - 1,2,3级)**

- Hole exhibits flare but it does not violate minimum annular ring requirements.
- 孔呈现锥口，但没有违反最小环宽要求。

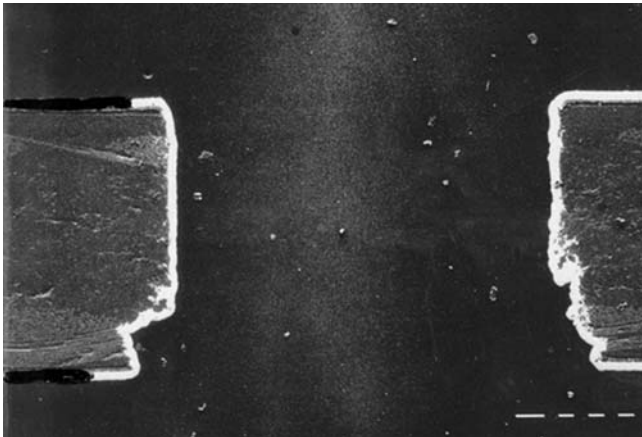

图352c

**Nonconforming - Class 1,2,3 (不符合条件 - 1,2,3级)**

- Defects either do not meet or exceed above criteria.
- 缺陷不符合或超出上述要求。

Visual observations made on cross-sections only. (仅对显微切片进行目检观察。)

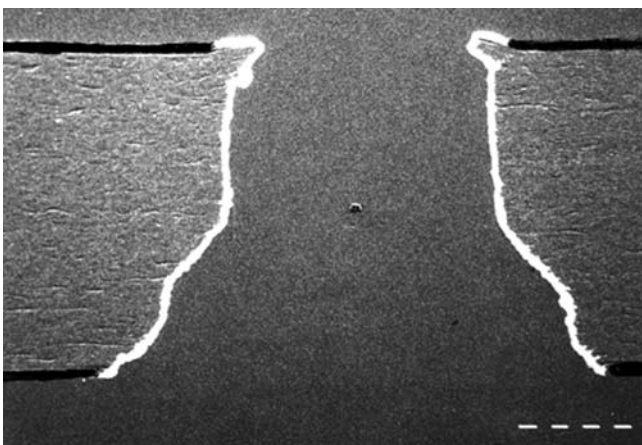
### Introduction (引言)

This section provides acceptability criteria for several special printed board types. The distinctive features of these special printed board types require supplementing the general acceptability criteria. For each special printed board type, this section outlines where and how the general acceptability criteria are supplemented. The special printed board types are:

- Flexible
- Rigid-Flex
- Metal Core
- Flush

本节为几种特殊类型的印制板提供了可接受性准则。这些特殊类型印制板的某些特性要求，在通用验收准则之外还需补充若干规定。对于每种特殊类型板来说，本节指出在通用验收准则的何处及怎样作补充。这些特殊类型板是：

- 挠性板
- 刚挠性板
- 金属芯板
- 齐平板

## Introduction (引言)

This section covers the acceptability requirements specific to flexible and rigid-flex printed boards. Parameters not covered in this section are to be evaluated using the other sections of this document.

The numeric type designator for flexible and rigid-flex printed boards differs from that of rigid printed boards. The various types for flexible and rigid-flex printed boards are defined as follows:

- Type 1** Single-sided flexible printed boards containing one conductive layer, with or without stiffeners.
- Type 2** Double-sided flexible printed boards containing two conductive layers with PTHs, with or without stiffeners.
- Type 3** Multilayer flexible printed board containing three or more conductive layers with PTHs, with or without stiffeners.
- Type 4** Multilayer rigid and flexible material combinations containing three or more layers with PTHs.
- Type 5** Flexible or rigid-flex printed boards containing two or more conductive layers without PTHs.

The types referred to in this section on flexible and rigid-flex printed boards will use the definitions above.

The physical requirements for folding flexibility and flexibility endurance are not described in this document. If required by the procurement documentation, refer to IPC-6013 for details.

本节涵盖了挠性和刚挠性印制板的可接受性要求。本节未涉及的参数可采用本文件其它章节来评定。

挠性和刚挠性印制板的数字类型代码与刚性印制板是不同的。挠性和刚挠性印制板的数字类型代码定义如下：

- 1型板** 包含一层导电层的挠性单面印制线路，有或没有增强板。
- 2型板** 包含两层导电层的挠性双面印制线路，有镀覆孔；有或没有增强板。
- 3型板** 包含三层或三层以上导电层的挠性多层印制线路，有镀覆孔、有或没有增强板。
- 4型板** 包含三层或三层以上导电层的刚性多层和挠性材料组合，有镀覆孔。
- 5型板** 包含两层或两层以上导电层的挠性或刚挠印制线路，没有镀覆孔。

本节有关挠性和刚挠性印制板类型将采用上述定义。

本文件未涉及折叠挠曲性和耐挠折性的物理要求。如采购文件有要求，其详细要求参见IPC-6013。

## 4.1.1 Coverlay Coverage – Coverfilm Separations (覆盖层覆盖 – 覆盖膜分离)

Imperfections such as wrinkles, creases, and nonlamination are acceptable provided they do not exceed the limits for foreign inclusions in 2.3.4 and the limits below.

褶皱、折痕和非层压之类的瑕疵，只要未超过下述限制及2.3.4节对外来夹杂物的限制，都是可接受的。



图411a



图411b

**Target Condition - Class 1,2,3 (目标条件 - 1,2,3级)**

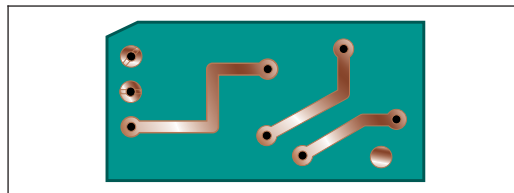
- Uniform and no separations or delamination.
- No wrinkles, creases or soda strawing.
- 覆盖层均匀无分离或分层。
- 无褶皱、折痕或吸管状空隙。

**Acceptable - Class 1,2,3 (可接受条件 - 1,2,3级)**

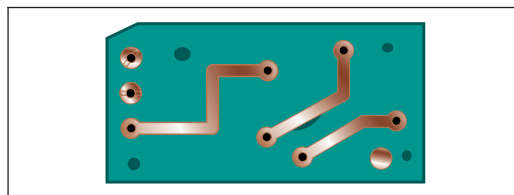
Delamination and nonlamination meets the following criteria:

- At random locations away from conductors, each separation is no larger than 0.80 x 0.80 mm [0.0315 x 0.0315 in] and is not within 1.0 mm [0.0394 in] of the printed board edge or the coverfilm opening.
- The total number of separations does not exceed three in any 25 x 25 mm [0.984 x 0.984 in] of coverfilm surface area.
- The total separation does not exceed 25% of the spacing between adjacent conductors.
- No coverfilm nonlamination along the outer edges of the coverfilm.

分离和未层压住符合以下准则：

- 在远离导体的随机位置，每处分离不大于0.80x0.80mm[0.0315inx0.0315 in]且不在距板边或覆盖膜开口1.0mm[0.0394in]范围内。
- 在覆盖膜表面任一25mmx25mm[0.984inx0.984in]的区域内，分离总数未超过3个。
- 分离的总长度没有超过相邻导体间距的25%。
- 沿覆盖膜外部边缘的覆盖膜没有出现未层压住。



图411c



图411d

**Nonconforming - Class 1,2,3 (不符合条件 - 1,2,3级)**

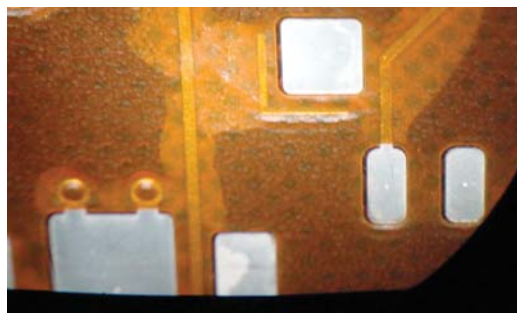
- Defects either do not meet or exceed above criteria.
- 缺陷不符合或超出上述要求。

## 4.1.2 Coverlay/Covercoat Coverage – Adhesives (覆盖层/覆盖涂层的覆盖 – 粘接剂)

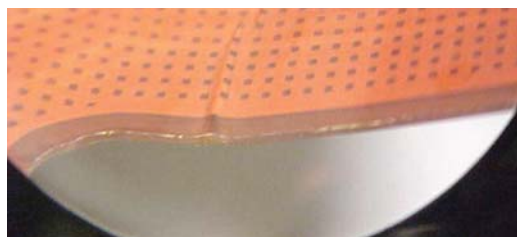
The covercoat coverage **shall** have the same requirements as the solder mask coatings in the rigid printed board section of this document. This section covers the acceptability requirements for coverlay coverage including squeeze-out of adhesive over the solderable land area and foil surface.

覆盖层的覆盖要求应当与本文件中刚性印制板一节规定的阻焊膜涂层的要求相同。本节覆盖层的覆盖可接受性要求包括下述的焊盘和铜箔表面挤出的粘接剂。

## 4.1.2.1 Adhesive Squeeze-Out – Land Area (焊盘区域粘接剂的挤出)



图4121a

**Target Condition - Class 1,2,3 (目标条件 - 1,2,3级)**

- No unwanted material on land area.
- 焊盘区域无多余的材料。

**Acceptable - Class 3 (可接受条件 - 3级)**

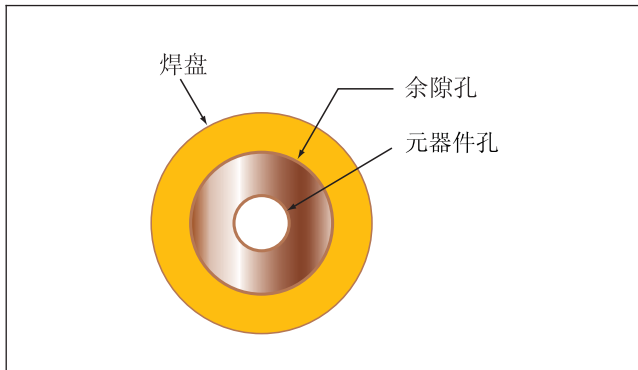
- A 0.05 mm [0.00197 in] solderable annular ring for 360° of the circumference.
- 圆周360°范围内有0.05mm[0.00197in]宽的可焊孔环。



图4121b

**Acceptable - Class 2 (可接受条件 - 2级)**

- A 0.05 mm [0.00197 in] solderable annular ring for at least 270° of the circumference.
- 圆周至少270°范围内有0.05mm[0.00197in]宽的可焊孔环。

**Acceptable - Class 1 (可接受条件 - 1级)**

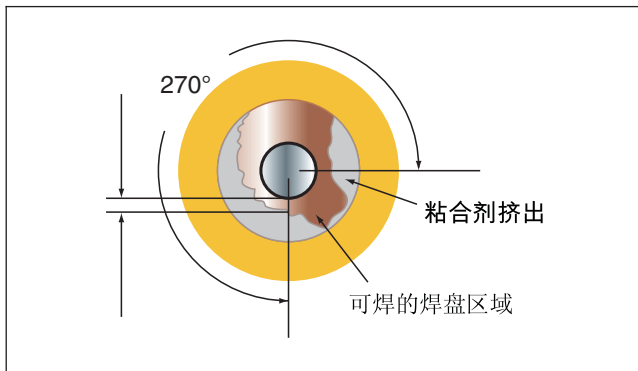
- A solderable annular ring for at least 270° of the circumference.
- 圆周至少270°范围内有可焊孔环。

**Nonconforming - Class 1,2,3 (不符合条件 - 1,2,3级)**

- Defects either do not meet or exceed above criteria.
- 缺陷不符合或超出上述要求。



4.1.2.2 Adhesive Squeeze-Out – Foil Surface (铜箔表面粘接剂的挤出)



图4122a

**Target Condition - Class 1,2,3 (目标条件 - 1,2,3级)**

- No unwanted material on foil surface.
- 铜箔表面没有多余材料。

**Acceptable - Class 3 (可接受条件 - 3级)**

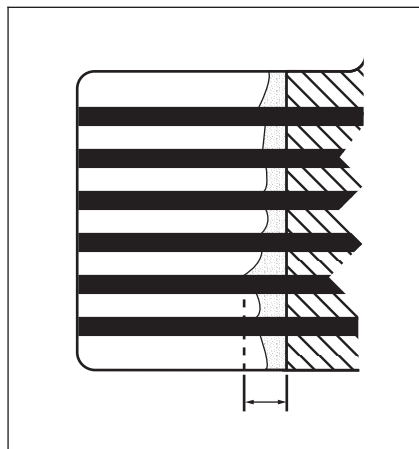
**70 μm foil and below: (对于70μm及以下铜箔:)**

- ≤0.2 mm [0.0079 in].
- ≤0.2mm[0.0079in].

**Above 70 μm foil (对于70μm以上铜箔:)**

- ≤0.4 mm [0.0157 in] or AABUS.
- ≤0.4mm[0.0157in]或由供需双方协商确定。

**Acceptable - Class 1,2 (可接受条件 - 1,2级)**

**70 μm foil and below: (对于70μm及以下铜箔:)**

- ≤0.3 mm [0.0118 in]
- ≤0.3mm[0.0118in]

**Above 70 μm foil (对于70μm以上铜箔:)**

- ≤0.5 mm [0.0197 in] or AABUS.
- ≤0.5mm[0.0197in]或由供需双方协商确定。



图4122b



图4122c

**Nonconforming - Class 1,2,3 (不符合条件 - 1,2,3级)**

- Defects either do not meet or exceed above criteria.
- 缺陷不符合或超出上述要求。

## 4.1.3 Access Hole Registration for Coverlay and Stiffeners (元器件孔与覆盖层及增强板的重合度)

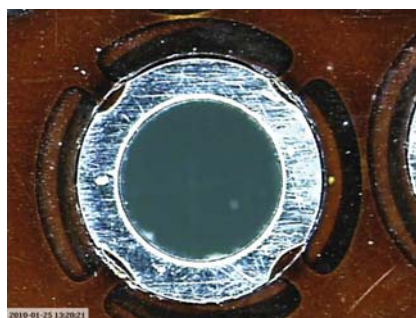
In cases where anchoring spurs are attached to the lands, they **shall** be lapped by the coverlay.

当焊盘上有盘趾时，覆盖层应当将盘趾覆盖。



图413a



图413b

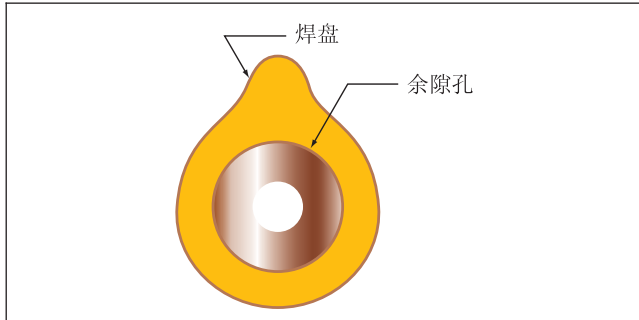

图413c

**Target Condition - Class 1,2,3 (目标条件 - 1,2,3级)**

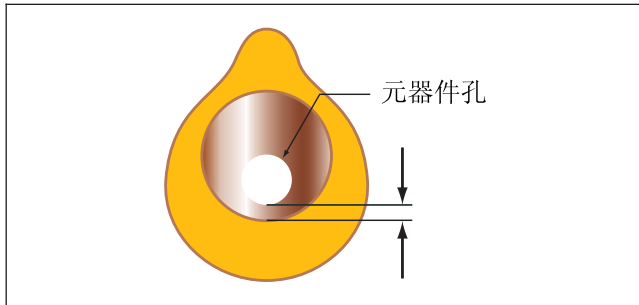
- Meets nominal registration.
- 满足标称的重合度要求。

**Acceptable - Class 3 (可接受条件 - 3级)**

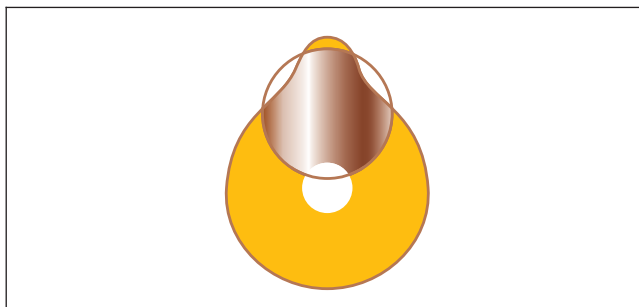
- Coverlay or stiffener does not extend into the hole.
- For supported holes, a solderable annular ring of 0.05 mm [0.00197 in] or more for the full circumference.
- For unsupported holes, a solderable annular ring of 0.25 mm [0.00984 in].
- 覆盖层或增强板没有延伸至孔内。
- 对于支撑孔，整个圆周上可焊孔环等于或大于0.05mm [0.00197in]。
- 对于非支撑孔，可焊孔环不小于0.25mm[0.00984in]。

**Acceptable - Class 2 (可接受条件 - 2级)**

- Coverlay or stiffener does not extend into the hole.
- A solderable annular ring for 270° or more of the circumference.
- 覆盖层或增强板没有延伸至孔内。
- 圆周上大于等于270°范围内有可焊孔环。

**Acceptable - Class 1 (可接受条件 - 1级)**

- Coverlay or stiffener does not extend into the hole.
- A solderable annular ring for 180° or more of the circumference.
- 覆盖层或增强板没有延伸至孔内。
- 圆周上大于等于180°范围内有可焊孔环。

**Nonconforming - Class 1,2,3 (不符合条件 - 1,2,3级)**

- Defects either do not meet or exceed above criteria.
- 缺陷不符合或超出上述要求。

## 4.1.4 Plating Defects (镀层缺陷)



图414a



图414b

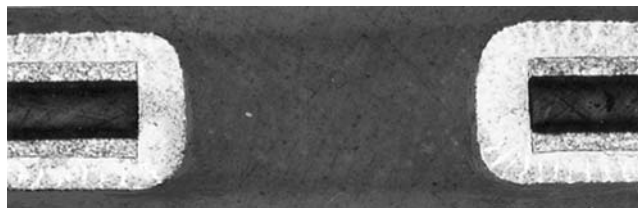

图414c

**Target Condition - Class 1,2,3 (目标条件 - 1,2,3级)**

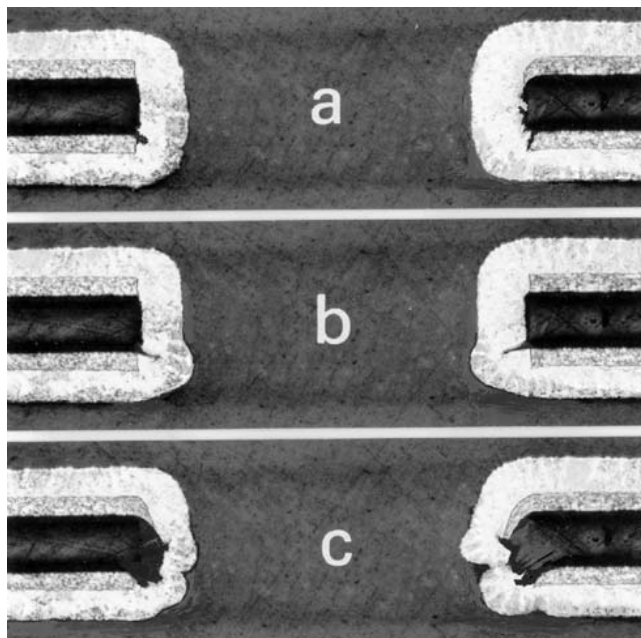
- Plating is uniform and meets the minimum thickness requirements.
- No defects of the plating or base material present.
- 镀层均匀一致且满足最小厚度要求。
- 镀层或基材不存在缺陷。

**Acceptable - Class 1,2,3 (可接受条件 - 1,2,3级)**

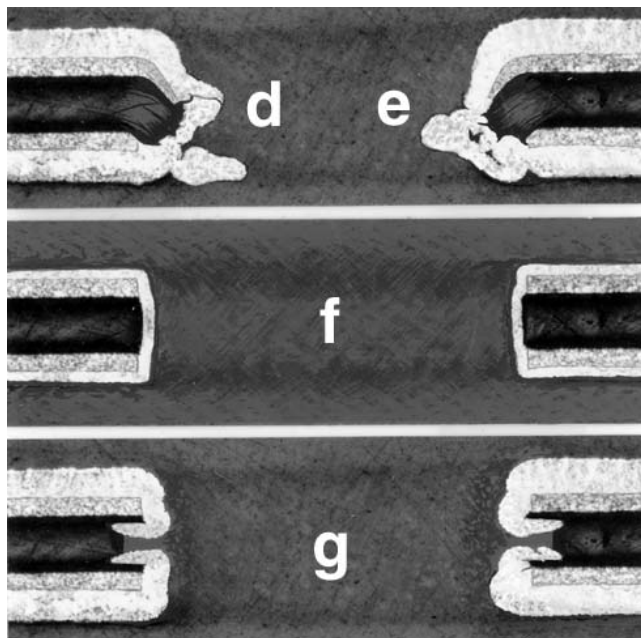
- Minor defects present but meet the minimum requirements:
  - a. Slight deformation of base material and minor smear.
  - b. Adhesive or dielectric filament with small nodule, but copper thickness meets minimum requirements.
  - c. Localized thin and non-uniform plating; copper slightly thin over one corner and minor extrusion of base material, but copper thickness meets minimum requirements.
- 出现轻微缺陷，但满足最小要求：
  - a. 基材轻微变形并有少量钻污。
  - b. 粘接剂或介质细丝有小的结瘤，但铜厚度满足最小要求。
  - c. 镀层局部偏薄和不均匀；其中一个拐角铜层稍薄和基材出现轻微突出，但铜厚度满足最小要求。

**Nonconforming - Class 1,2,3 (不符合条件 - 1,2,3级)**

- Defects either do not meet or exceed above criteria and/or the following:
  - d. Adhesive filament causing cracks in plating.
  - e. Nodules, extrusion and deformation of base material violate minimum hole size requirements.
  - f. Plating violates the minimum thickness requirement.
  - g. Circumferential voids.
- 缺陷不符合或超出上述要求。
  - d. 粘接剂细丝造成镀层裂缝；
  - e. 基材的结瘤、凸起和变形违反了最小孔径要求；
  - f. 镀层违反了最小厚度要求；
  - g. 出现环状空洞。

## 4.1.5 Stiffener Bonding (增强板的粘接)

The stiffener is evaluated for mechanical support only by way of the test method listed below.

只通过下列测试方法对增强板的机械支撑进行评定。



图415a

#### Acceptable - Class 1,2,3 (Stiffener) (可接受条件 - 1,2,3级 (增强板))

- Mechanical support is required; void-free bonding is not required.
- The stiffener does not reduce the solderable annular ring below the minimum solderable annular ring requirements.
- Peel strength between the flexible printed board and the stiffener, when tested in accordance with the method below, is a minimum of 1.4kg per 25 mm [0.984 in] width when bonded with thermoset adhesive and 0.38kg per 25 mm [0.984 in] width when bonded with pressure sensitive adhesive.
- 要求机械支撑，但不要求无空洞粘接。
- 增强板没有使可焊孔环的宽度减少至低于最小环宽要求。
- 挠性印制板和增强板之间的剥离强度，当按下述方法测试时，使用热固粘接剂时的剥离强度最低为1.4kg/25mm[0.984in]，使用压敏粘接剂时的剥离强度最低为0.38kg/25mm[0.984in]。

#### Acceptable - Class 3 (Adhesive) (可接受条件 - 3级) (粘接剂)

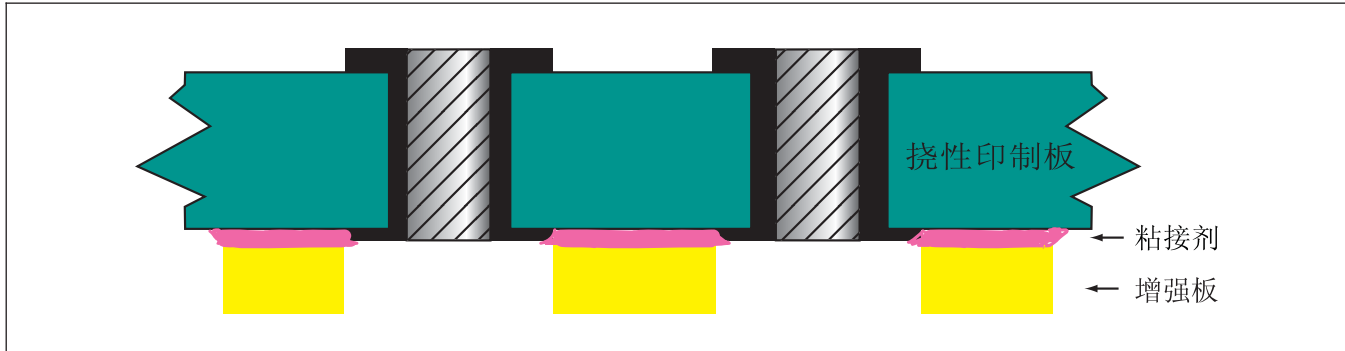
- The adhesive used to bond the stiffener does not reduce the solderable annular ring below the minimum solderable annular ring requirements.
- The total area of voids does not exceed 10% of the stiffener surface area.
- Each void does not exceed 2.5 mm [0.0984 in] in the longest dimension.
- 用于粘接增强板的粘接剂未使可焊孔环的宽度减少至低于最小环宽要求。
- 总的空洞区域未超过增强板表面面积的10%。
- 每个空洞的最长尺寸不超过2.5mm[0.0984in]。

#### Acceptable - Class 2 (Adhesive) (可接受条件 - 2级) (粘接剂)

- The adhesive used to bond the stiffener does not reduce the solderable annular ring below the minimum solderable annular ring requirements.
- The total area of voids does not exceed 20% of the stiffener surface area.
- Each void does not exceed 2.5 mm [0.0984 in] in the longest dimension.
- 用于粘接增强板的粘接剂未使可焊孔环的宽度减少至低于最小环宽要求。
- 总的空洞区域未超过增强板表面面积的20%。
- 每个空洞的最长尺寸不超过2.5mm[0.0984in]。

### 4.1.5 Stiffener Bonding (增强板的粘接 (续))

#### Acceptable - Class 1 (Adhesive) (可接受条件 - 1级) (粘接剂)

- The adhesive used to bond the stiffener does not reduce the solderable annular ring below the minimum solderable annular ring requirements.
- The total area of voids does not exceed 30% of the stiffener surface area.
- Each void does not exceed 2.5 mm [0.0984 in] in the longest dimension.
- 用于粘接增强板的粘接剂未使可焊孔环的宽度减少至低于最小环宽要求。
- 总的空洞区域未超过增强板表面面积的30%。
- 每个空洞的最长尺寸不超过2.5mm[0.0984in]。

#### Nonconforming - Class 1,2,3 (不符合条件 - 1,2,3级)

- Defects either do not meet or exceed above criteria.
- 缺陷不符合或超出上述要求。

**Test Method:** Using a sharp instrument such as a scalpel or razor blade, cut approximately 10 mm [0.394 in] wide by 80 mm [3.15 in] long through the flexible printed board to the stiffener so that approximately halfway through the peeling operation the sample will be perpendicular to the pull. Pull at a rate of  $50 \pm 6.3$  mm/minute. Take readings at the beginning, middle, and end of the pull, and average the reading for acceptability.

**测试方法:** 用一种锋利的工具, 如解剖刀或剃须刀片, 沿着挠性线路往增强板方向切割出一条宽约为10mm[0.394in]、长约为80mm[3.15in]的粘接剂带, 因此在剥离操作进行至约一半时样品将与剥离的方向成直角。剥离的速度为 $50 \pm 6.3$ mm/min。在剥离操作的开始、中间和终止时记下测量数据, 将测量数据平均从而确定可接受性。



### 4.1.6 Transition Zone, Rigid Area to Flexible Area (刚性区域与挠性区域的过渡区)

The transition zone is the area centered at the edge of the rigid portion from which the flexible portion extends. The inspection range is limited to 3.0 mm [0.12 in], about the center of the transition, which is the edge of the rigid portion.

过渡区以刚性段和挠性段的边缘为中心。检验范围局限于过渡区的中心（即刚性段的边缘）附近3mm[0.12in]内。



图416a



图416b

#### Acceptable - Class 1,2,3 (可接受条件 - 1,2,3级)

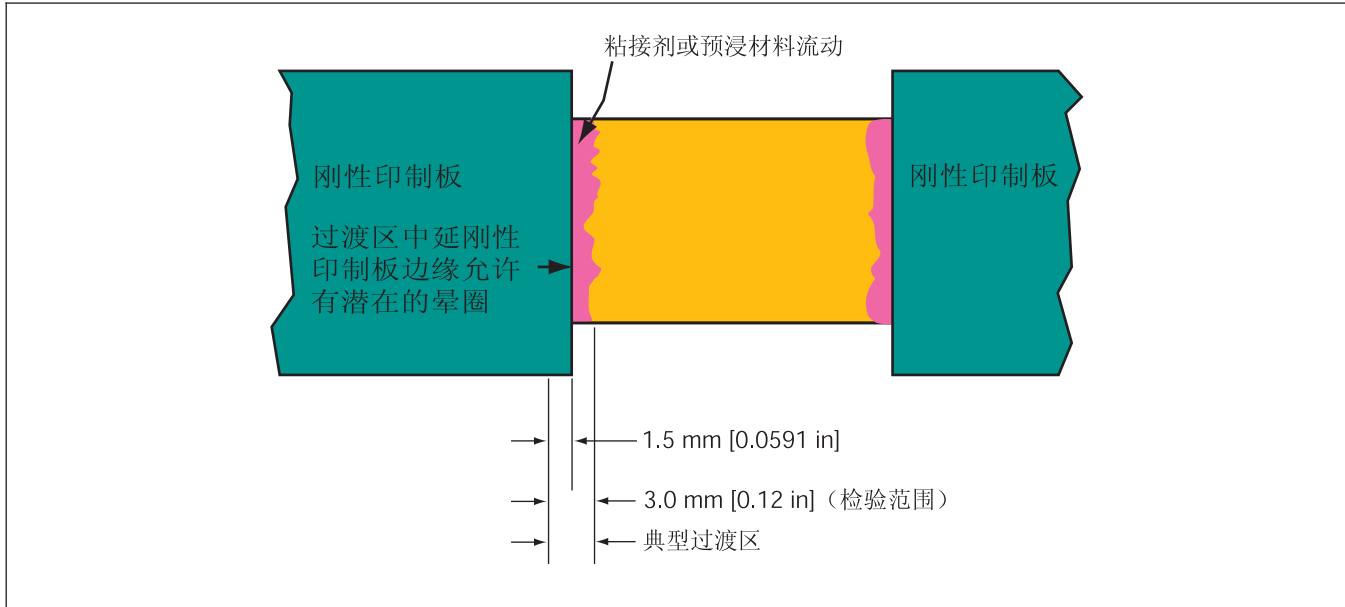
- Adhesive squeeze-out.
- Localized deformation of dielectric or conductors.
- Protruding dielectric material.
- 粘接剂挤出。
- 介质或导体的局部变形。
- 介质材料的突出。

#### Nonconforming - Class 1,2,3 (不符合条件 - 1,2,3级)

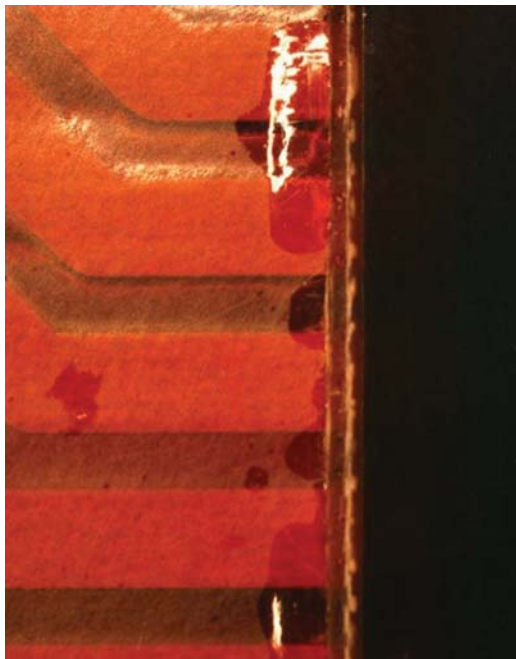
- Defects either do not meet or exceed above criteria.
- 缺陷不符合或超出上述要求。

## 4.1.7 Solder Wicking/Plating Penetration Under Coverlay (覆盖层下的焊料芯吸/镀层渗透)



图417a

**Target Condition - Class 1,2,3 (目标条件 - 1,2,3级)**

- Solder or plating on land covers all exposed metal and stops at coverlay.
- Solder wicking or plating penetration does not extend into the bend or flex transition area.
- 焊盘上的焊料或镀层覆盖了所有裸露的金属并止于覆盖层。
- 焊料芯吸或镀层渗透未延伸至弯曲或挠性过渡区域。

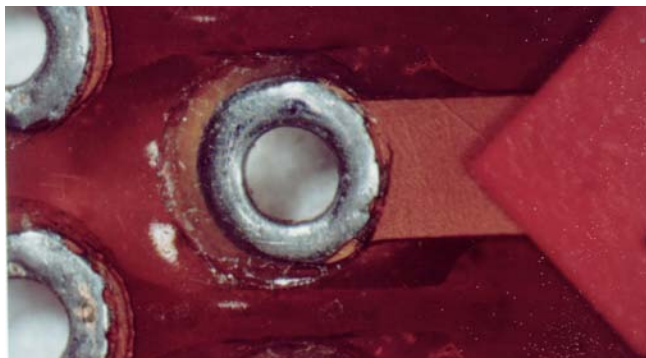

图417b

**Acceptable - Class 3 (可接受条件 - 3级)**

- Solder wicking/plating penetration does not extend under coverlay more than 0.1 mm [0.004 in].
- Solder wicking or plating penetration does not extend into the bend or flex transition area.
- Meets conductor spacing requirements.
- 焊料芯吸/镀层渗透在覆盖层下延伸不超过0.1mm[0.004in]。
- 焊料芯吸或镀层渗透没有延伸至弯曲或挠性过渡区域。
- 满足导体间距要求。

**Acceptable - Class 2 (可接受条件 - 2级)**

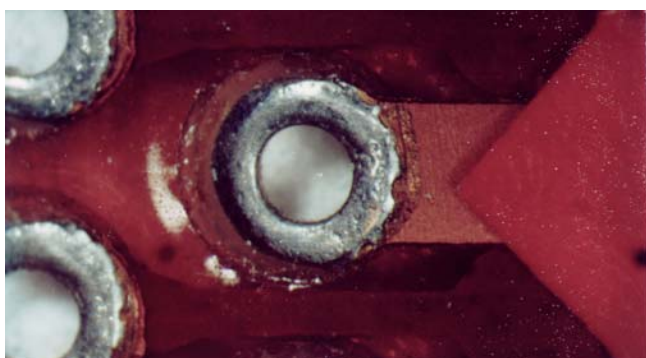
- Solder wicking/plating penetration does not extend under coverlay more than 0.3 mm [0.012 in].
- Solder wicking or plating penetration does not extend into the bend or flex transition area.
- Meets conductor spacing requirements.
- 焊料芯吸或镀层渗透在覆盖层下延伸不超过0.3mm[0.012 in]。
- 焊料芯吸或镀层渗透没有延伸至弯曲或挠性过渡区域。
- 满足导体间距要求。

### 4.1.7 Solder Wicking/Plating Penetration Under Coverlay (覆盖层下的焊料芯吸/镀层渗透 (续))



图417c

#### Acceptable - Class 1 (可接受条件 - 1级)

- Solder wicking/plating penetration does not extend under coverlay more than 0.5 mm [0.020 in].
- Solder wicking or plating penetration does not extend into the bend or flex transition area.
- Meets conductor spacing requirements.
- 焊料芯吸或镀层渗透在覆盖层下延伸不超过0.5mm[0.012 in]。
- 焊料芯吸或镀层渗透没有延伸至弯曲或挠性过渡区域。
- 满足导体间距要求。

#### Nonconforming - Class 1,2,3 (不符合条件 - 1,2,3级)

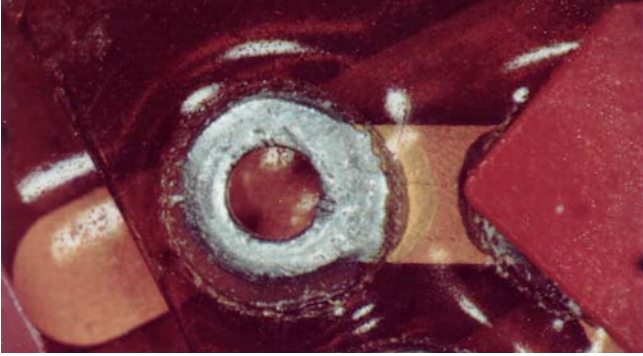
- Defects either do not meet or exceed above criteria.
- 缺陷不符合或超出上述要求。

## 4.1.8 Laminate Integrity (层压板完整性)

This section shows the voids and cracks that may be present in flexible or rigid-flex printed boards. The requirements for the flexible portion differ from the rigid-flex portion and are defined in the text even though only a rigid-flex section is shown.

本节讨论挠性或刚挠印制板上可能出现的空洞和裂缝。挠性部分的要求与刚挠印制部分有所不同，尽管只图示出了刚挠印制线路部分，但正文对挠性印制线路作了规定。



图418a

## Notes:

1. The thermal zone extends 0.08 mm [0.0031 in] beyond the end of the land that is most radially extended.
2. Laminate anomalies or imperfections in Zone A areas are not evaluated on specimens, which have been exposed to thermal stress or rework simulation.
3. Multiple voids or cracks between PTHs in the flex area and in the same plane **shall not** have combined length exceeding the limit.

## 注:

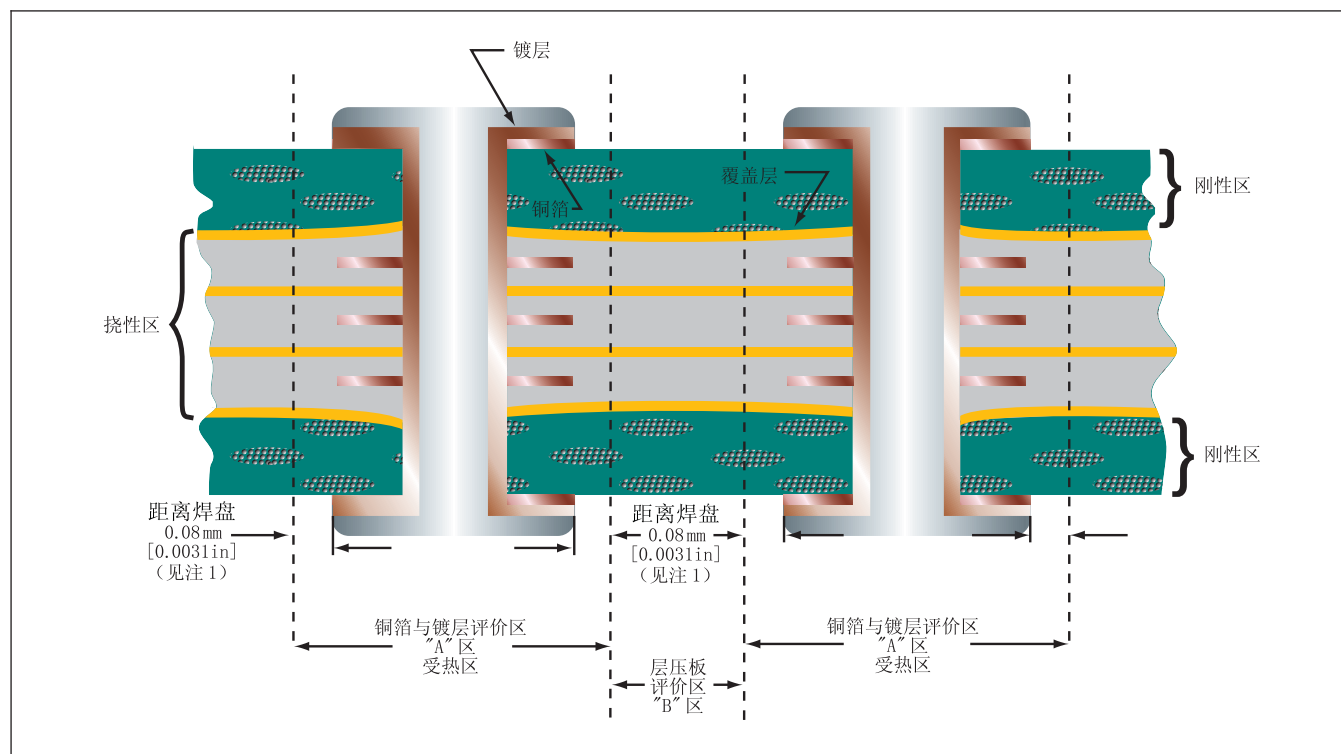
1. 受热区是指从内层或外层中最靠外的焊盘边缘向层压板延伸0.08mm[0.0031in]所包含的区域。
2. 对已经经受热应力测试或模拟返工测试的试样，A区内出现的层压板异常或瑕疵不作评价。
3. 在挠性区域内同一层面上镀覆孔间的多个空洞或裂缝，其累积长度**不应当**超出规定限值。

## Target Condition (目标条件)

- No laminate voids or cracks.
- 无层压板空洞或裂缝。

## 4.1.8.1 Laminate Integrity – Flexible Printed Board (层压板完整性 – 挠性印制板)



图4181a

## Notes:

1. The thermal zone extends 0.08 mm [0.0031 in] beyond the end of the land that is most radially extended.
2. Multiple voids or cracks between PTHs and in the same plane **shall not** have combined length exceeding the limits for all classes.

## 注:

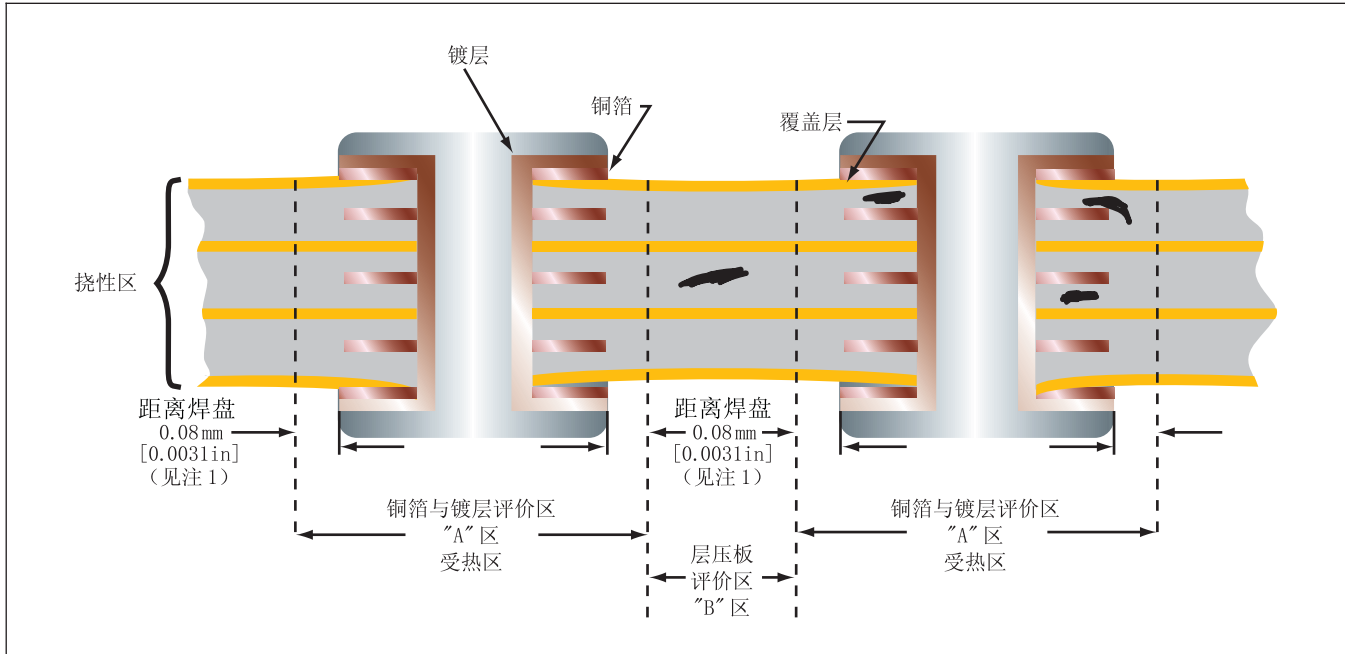
1. 受热区是指从内层或外层中最靠外的焊盘边缘径向延伸0.08mm[0.0031in]所包含的区域。
2. 对于所有级别产品，在同一层面上镀覆孔间的多个空洞或裂缝，其累积长度**不应当**超出规定的限值。

## Target Condition (目标条件)

- No laminate voids or cracks.
- 无层压板空洞或裂缝。

## Acceptable - Class 1,2,3 (可接受条件 - 1,2,3级)

- Laminate voids or cracks are not evaluated in Zone A.
- Laminate voids or cracks in the flexible printed board do not exceed 0.50 mm [0.020 in] in Zone B.
- A区内层压空洞或裂缝不作评定。
- 挠性印制电路在B区中的层压空洞或裂缝不超过0.50mm[0.020in]。

## Nonconforming - Class 1,2,3 (不符合条件 - 1,2,3级)

- Defects either do not meet or exceed above criteria.
- 缺陷不符合或超出上述要求。



## 4.1.8.2 Laminate Integrity – Rigid-Flex Printed Board (层压板的完整性 – 刚挠性印制板)



图4182a

## Notes:

1. The thermal zone extends 0.08 mm [0.0031 in] beyond the end of the land that is most radially extended.
2. Multiple voids or cracks between PTHs in the flex area and in the same plane **shall not** have combined length exceeding the limits for all classes

## 注:

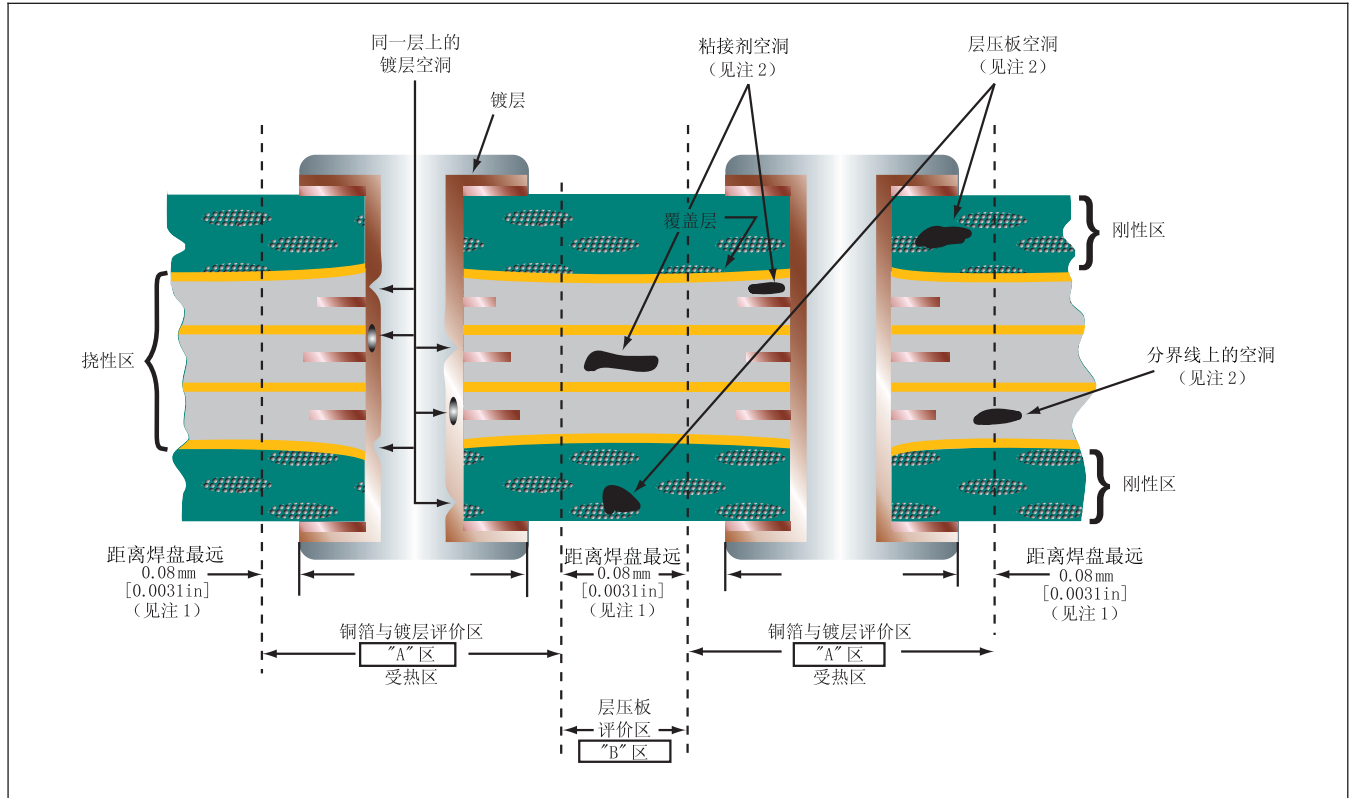
1. 受热区是指从内层或外层中最靠外的焊盘边缘径向延伸0.08mm[0.0031in]所包含的区域。
2. 对于所有级别产品，在挠性区域内同一层面上镀覆孔间的多个空洞或裂缝，其累积长度**不应当**超出规定的限值。

## Target Condition (目标条件)

- No laminate or adhesive voids or cracks.
- 无层压板或粘接剂空洞或裂缝。

## Acceptable - Class 2,3 (可接受条件 - 2,3级)

- Laminate voids or cracks are not evaluated in Zone A.
- Laminate voids or cracks that originate in Zone A and extend into Zone B or are entirely in Zone B, in the rigid portion of the printed board, are not in excess of 0.08 mm [0.0031 in] in Zone B.
- Adhesive voids or cracks that originate in Zone A and extend into Zone B or are entirely in Zone B, in the flexible portion of the printed board, are not in excess of 0.5 mm [0.020 in] in Zone B.
- A区中层压板空洞或裂缝不作评定。
- 在印制板刚性部分，从A区延伸到B区或完全在B区中的层压板空洞或裂缝不超过0.08mm[0.0031in]。
- 在印制板挠性部分，从A区延伸到B区或完全在B区中的粘接剂空洞或裂缝不超过0.5mm[0.020in]。

## Acceptable - Class 1 (可接受条件 - 1级)

- Laminate voids or cracks are not evaluated in Zone A.
- Laminate voids or cracks that originate in Zone A and extend into Zone B or are entirely in Zone B, in the rigid portion of the printed board, are not in excess of 0.15 mm [0.00591 in] in Zone B.
- Adhesive voids or cracks that originate in Zone A and extend into Zone B or are entirely in Zone B, in the flexible portion of the printed board, are not in excess of 0.5 mm [0.020 in] in Zone B.
- A区中层压板空洞或裂缝不作评定。
- 在印制板刚性部分，从A区延伸到B区或完全在B区中的层压板空洞或裂缝不超过0.15mm[0.00591in]。
- 在印制板挠性部分，从A区延伸到B区或完全在B区中的粘接剂空洞或裂缝不超过0.5mm[0.020in]。

## Nonconforming - Class 1,2,3 (不符合条件 - 1,2,3级)

- Defects either do not meet or exceed above criteria.
- 缺陷不符合或超出上述要求。

## 4.1.9 Etchback (Type 3 and Type 4 Only) (凹蚀 (仅3型和4型板))



图419a

**Note:** Due to various materials used in the construction of rigid-flex printed boards, varying degrees of preferential etchback are exhibited among the various materials.

**注:** 由于刚挠印制板结构使用的材料不同, 各种材料的首选凹蚀程度也各不相同。

**Target Condition/Acceptable - Class 1,2,3 (目标条件/可接受条件 - 1,2,3级)**

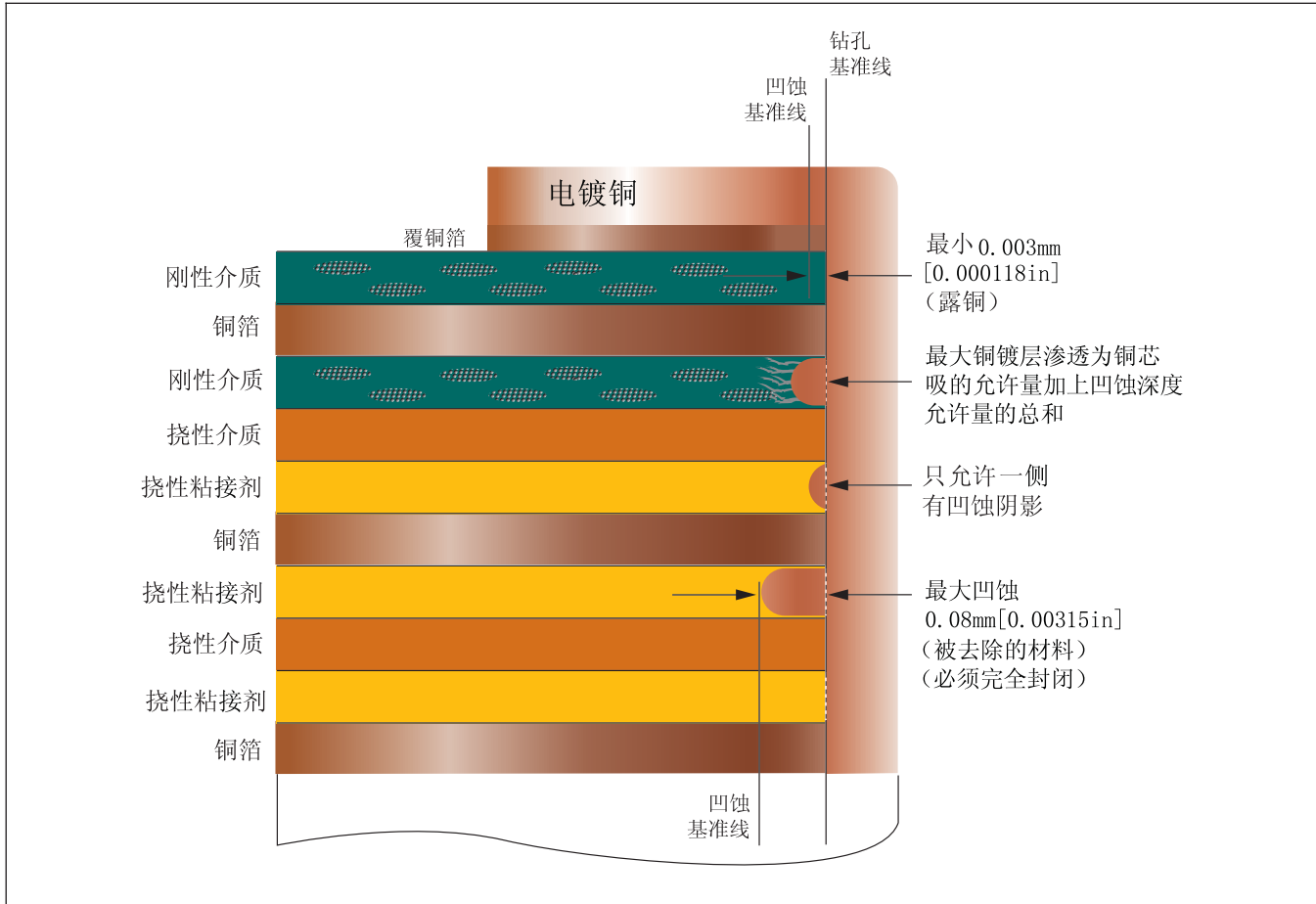
- Etchback between 0.003 and 0.08 mm [0.00012 and 0.0031 in].
- Shadowing permitted on one side of each land.
- 凹蚀深度在0.003mm[0.00012in]和0.08mm[0.0031in]之间。
- 允许每个焊盘的一侧出现凹蚀阴影。

**Nonconforming - Class 1,2,3 (不符合条件 - 1,2,3级)**

- Defects either do not meet or exceed above criteria.
- 缺陷不符合或超出上述要求。

**Caution:** Etchback greater than 0.05 mm [0.0020 in] may cause folds or voids in the plating, which then may not meet the required copper thickness.

**注意:** 大于0.05mm[0.0020in]的凹蚀可能会在镀层中造成折叠或空洞, 因此可能不能满足要求的铜厚。

## 4.1.10 Smear Removal (Type 3 and 4 Only) (去钻污 (仅3型和4型板))

Smear removal is the removal of debris that results from the formation of the hole. Smear removal should be sufficient to completely remove resin from the surface of conductor interface.

去钻污是除去在孔形成时产生的碎屑。去钻污应该足以完全除去导体界面表面的树脂。



图4110a

**Note:** Smear removal is not required of Type 1 or Type 2 flexible printed boards.

**注:** 对于1型和2型挠性印制板, 不要求去钻污。

## Target Condition/Acceptable - Class 1,2,3 (目标条件/可接受条件 - 1,2,3级)

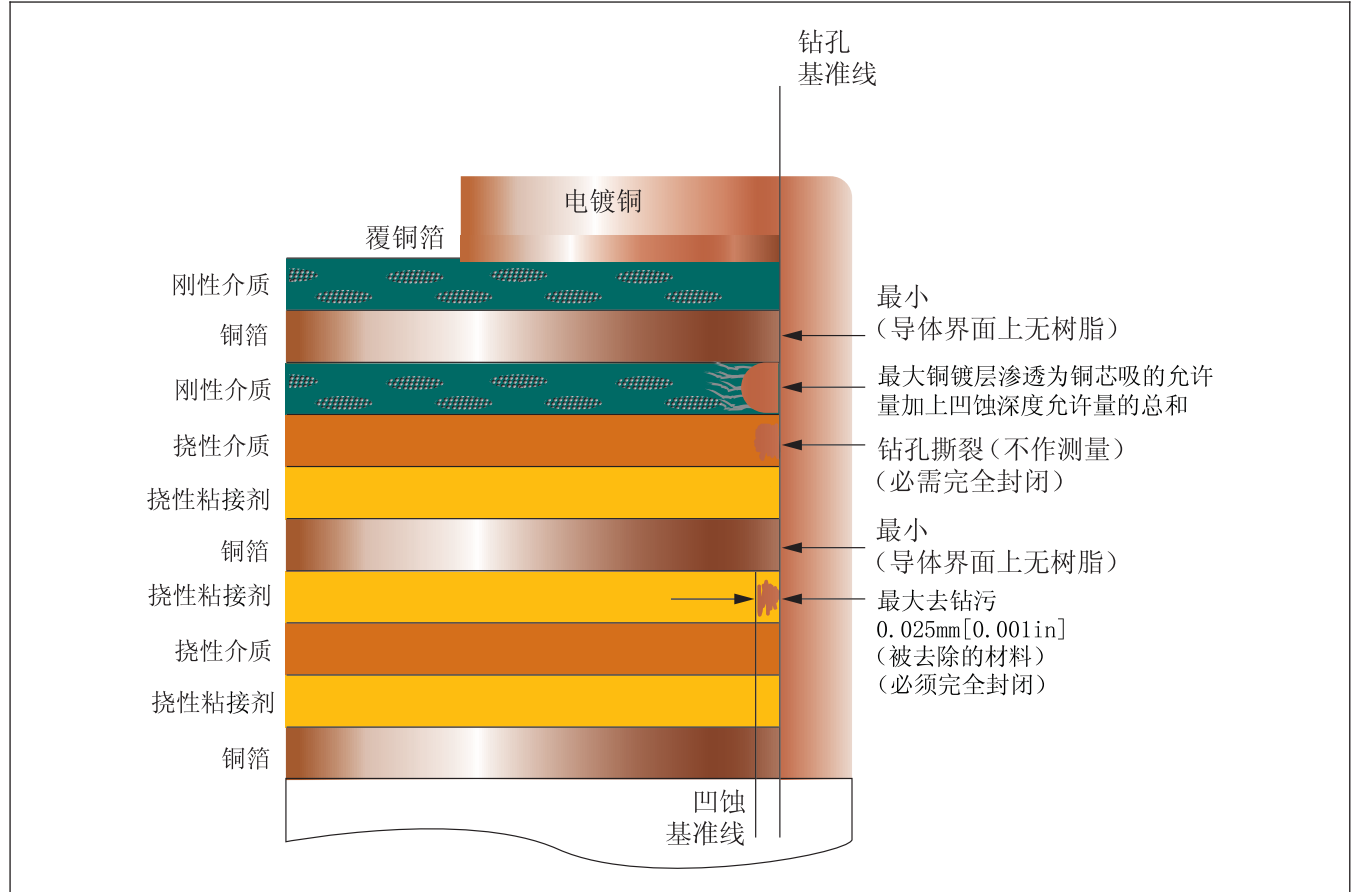
- Smear removal process not etched back more than 0.025 mm [0.001 in].
- Random tears or gouges that produce small areas where the 0.025 mm [0.001 in] depth is exceeded, provided dielectric spacing is maintained.
- 去钻污过程没有使凹蚀超过0.025mm[0.001in]。
- 在满足介质间距的情况下, 小区域产生的深度超过0.025mm[0.001in]的随机撕裂或凿槽是可接受的。

## Nonconforming - Class 1,2,3 (不符合条件 - 1,2,3级)

- Defects either do not meet or exceed above criteria.
- 缺陷不符合或超出上述要求。

## 4.1.11 Trimmed Edges/Edge Delamination (裁切边缘/边缘分层)



图4111a



图4111b



图4111c

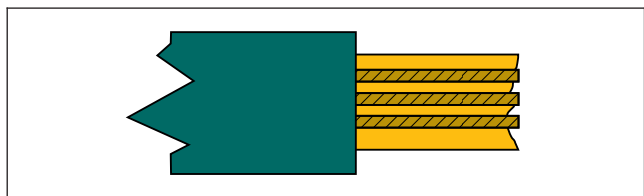

图4111d

**Target Condition - Class 1,2,3 (目标条件 - 1,2,3级)**

- Free of nicks and tears. Minimum edge to conductor spacing maintained.
- The trimmed edge of the flexible printed board or the flexible section of the finished rigid-flex printed board is free of burrs, nicks, delamination, and tears.
- 无缺口和撕裂。满足板边到导体的最小间距。
- 挠性印制板或已完工的刚挠印制板挠性段的裁切边缘无毛刺、无缺口、无分层且无撕口。

**Acceptable - Class 1,2,3 (可接受条件 - 1,2,3级)**

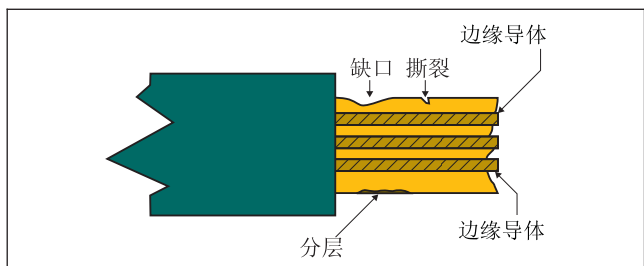
- No nicks, burrs or delamination in excess of that specified in the procurement documentation.
- No tears in Type 1 or Type 2 flexible printed boards.
- No tears in the flexible portion of Type 3 or Type 4 flexible printed boards.
- Nicks and tears that occur as a result of tie-in tabs to facilitate circuit removal as AABUS.
- Edge to conductor spacing of the flexible portion is within requirements specified on the procurement documentation.
- Nicks or haloing along the printed board edges, cutouts, and unsupported holes of the rigid portion of a rigid/flex printed board, providing the penetration does not exceed 50% of the distance from the edge to the nearest conductor or more than 2.5 mm [0.0984in], whichever is less.
- 缺口、毛刺或分层没有超过采购文件规定。
- 1型和2型挠性印制板中无撕口。
- 3型和4型挠性印制板的挠性段无撕口。
- 由于便于拆除电路连接头产生的缺口和撕口由供需双方协商确定。
- 挠性段板边到导体的间距在采购文件规定的要求范围内。
- 沿印制板板边、切割和刚挠性印制板刚性段上非支撑孔允许有缺口或晕圈，只要不超过板边到最近导体的距离的50%，或不超过2.5mm[0.0984in]，取两者中的较小值。

**Acceptable - AABUS (可接受条件 - 由供需双方协商确定)**

- When nicks and tears occur as a result of tie-in tabs to facilitate circuit removal, the extent of these imperfections does not exceed the requirements agreed to by user and supplier.
- 当缺口和撕口是由于为便于拆除电路由连接头而产生时，这些瑕疵的程度未超过由供需双方协商确定的要求。

4.1.11 Trimmed Edges/Edge Delamination (cont.) (裁切边缘/边缘分层 (续))



图4111e

**Nonconforming - Class 1,2,3 (不符合条件 - 1,2,3级)**

- Defects either do not meet or exceed above criteria.
- 缺陷不符合或超出上述要求。



图4111f



### 4.1.12 Fold/Bend Marks (折叠/弯曲痕迹)

A fold mark is characterized by bending in a sharp angle as shown in Figure 4112a. A bend mark is characterized by a bend whose radius is an obtuse angle, as shown in Figure 4112b.

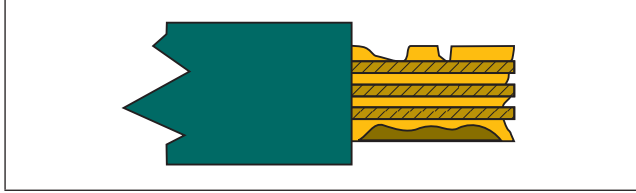
折叠痕迹是指如图4112a所示的以锐角角度弯曲造成的痕迹。弯曲痕迹是如图4112b所示的弯曲半径为钝角造成的痕迹。

#### Target Condition - Class 1,2,3 (目标条件 - 1,2,3级)

- Free of voids, scratches or foreign material.
- 无空洞、划痕或外来夹杂物。



图4112a

#### Acceptable - Class 1,2,3 (可接受条件 - 1,2,3级)

- The fold mark meets the requirements of 4.1.1 for coverlay coverage.
- No fold marks along the conductor pattern.
- No cracks or opening of the conductor pattern.
- Bending marks.
- 折叠痕迹满足4.1.1节覆盖层的覆盖要求。
- 沿着导体图形没有折叠痕迹。
- 导体图形没有裂缝或开口。
- 可有弯曲痕迹。

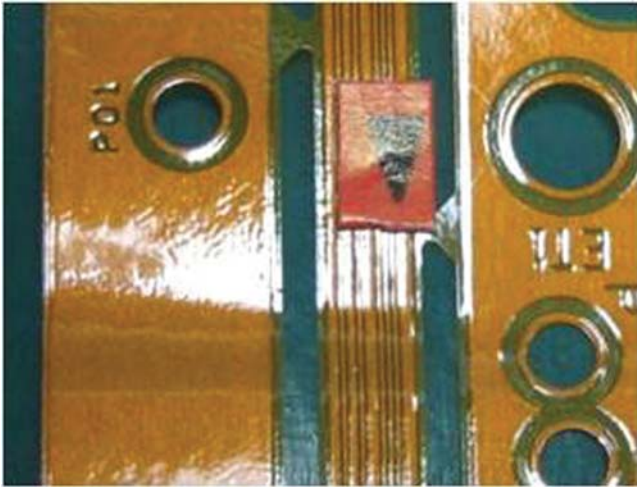

图4112b

#### Nonconforming - Class 1,2,3 (不符合条件 - 1,2,3级)

- Defects either do not meet or exceed above criteria.
- 缺陷不符合或超出上述要求。

## 4.1.13 Silver Film Integrity (银膜完整性)

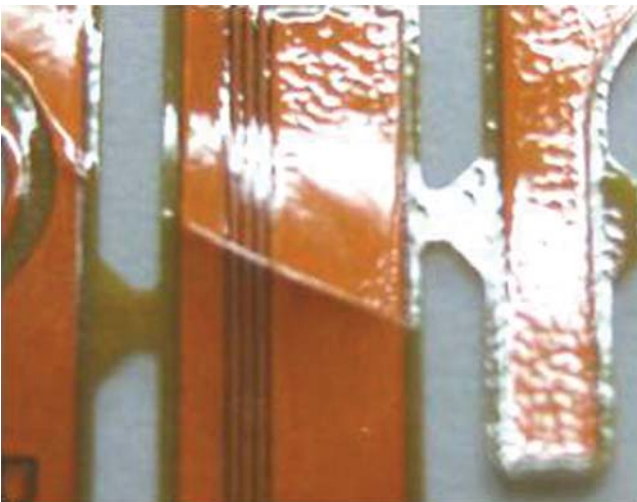
Silver film can be used for electro-static discharge (ESD) shielding in flexible printed boards. Scratches and voids may occur on the surface of the silver film when the liner material is peeled away.

银膜可用作挠性印制板的静电释放 (ESD) 屏蔽层。当覆盖膜材料被剥离时银膜表面可能会产生划痕和空洞。

**Target Condition - Class 1,2,3 (目标条件 - 1,2,3级)**

- Free of voids, scratches or foreign material.
- 无空洞、划痕或外来夹杂物。

**Acceptable - Class 1,2,3 (可接受条件 - 1,2,3级)**

- Voids, scratches or foreign material do not exceed 5 locations per side.
- Voids, scratches or foreign material do not expose metal underneath the silver film (exposed coverlay underneath is acceptable).
- Voids are less than 3.0 x 3.0 mm [0.118 x 0.118 in] in size.
- The width of scratches does not exceed 1.5 mm [0.060 in], and their length does not exceed 50% of the length of the flexible printed board.
- Touch up by black oil pen (see Figure 4113c).
- 每面的空洞、划痕或外来夹杂物不超过5处。
- 空洞、划痕或外来夹杂物未暴露银膜下的金属 (暴露覆盖层可接受)。
- 空洞尺寸小于3.0x3.0mm[0.118x0.118in]。
- 划痕宽度未超过1.5mm[0.060in], 且长度未超过挠性印制板长度的50%。
- 用黑色油性笔进行修补 (见图4113c)。



图4113a



图4113b

### 4.1.13 Silver Film Integrity (cont.) (银膜完整性 (续))

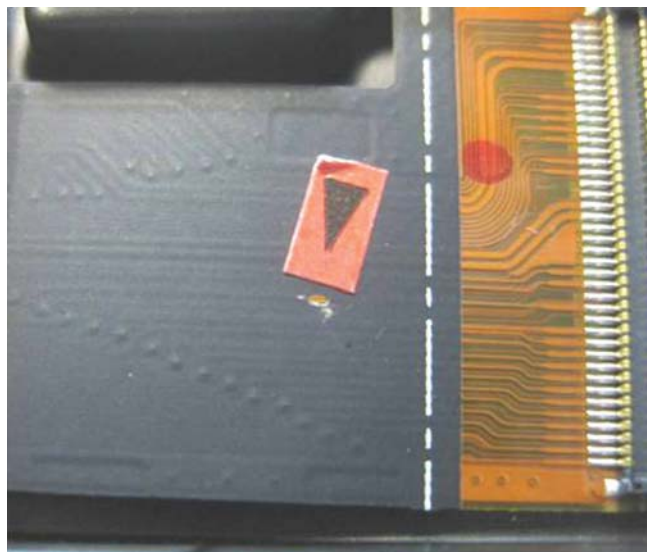

图4113c

**Nonconforming - Class 1,2,3**  
(不符合条件 - 1,2,3级)

- Defects either do not meet or exceed above criteria.
- 缺陷不符合或超出上述要求。

### Introduction (引言)

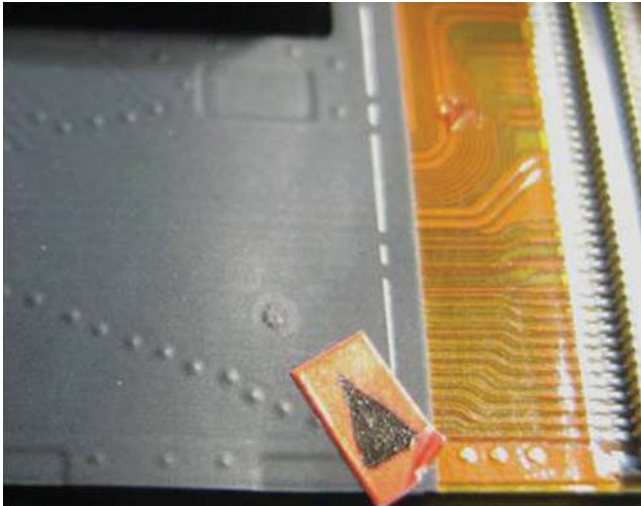
There are two types of metal core printed boards, both having one or more conductive patterns on each side of an insulated metal substrate. Interconnection between conductive patterns is made with PTHs.

In the first type, for double-sided printed boards, the metal core is laminated on each side with single-sided copper clad laminate to form a two-sided printed board with the conductors subsequently etched and plated by conventional printed board processes. For multilayer applications, additional etched internal layers may be laminated to the core or multiple cores. The cores may serve as a heat sink, a power or ground plane, or as a constraining plane to decrease the coefficient of thermal expansion (CTE) of the printed board in the planar direction.

For this type, the cores are commonly aluminum, copper, or (for CTE control) copper clad invar or molybdenum. If the cores are not to be electrically connected to the circuitry (as is normally the case with aluminum cores), clearance holes for PTHs are drilled or punched prior to lamination and filled with an insulating material. Copper cores may be electrically connected through the PTH. However, copper clad invar or molybdenum requires special processing to make acceptable electrical connections.

In the second type of metal core printed board, clearance holes are drilled, punched or machined in the bare core and it is then coated with an insulating material by spray coating, electrophoretic processes, or fluidized bed techniques. The coating must be pinhole free and of the specified thickness required to withstand electrical leakage and arc-over. After coating, the insulation is covered with electroless copper and plated and etched to provide required surface conductors and PTHs. For this type, the core may be copper, aluminum or steel, and most often acts as a heat sink or stiffener.

金属芯板有两种类型，两种类型都是在一个覆绝缘层金属基材的两面有一个或多个导电图形。导电图形之间的互连是通过镀覆孔来实现的。

在第一种类型中，对双面印制板来说，是在金属芯的两面层压单面覆铜层压板来形成双面板，接着采用常规的印制板工艺进行蚀刻和电镀制作导线。作为多层板应用时，另外蚀刻的内层层压到一个金属芯或多个金属芯上。这些金属芯可作为散热层、电源层或接地层，或者作为减小印制板在平面方向的热膨胀系数（CTE）的抑制层。

对于这种类型的金属芯印制板来说，其金属芯通常是铝、铜或（作为控制CTE用的）覆铜因瓦钢或钼板。如果金属芯不作为电气连接线路（这种情况下通常用铝芯），则对于镀覆孔的隔离孔要在层压之前钻孔或冲孔并用绝缘材料加以填充。铜金属芯可以通过镀覆孔来实现电气连接。但是，覆铜因瓦钢或钼芯材料则要求采用特殊加工才能获得可接受的电气连接。

在第二类的金属芯印制板中，隔离孔是在裸芯材中采用钻孔、冲孔或其它机械方法加工而成。然后采用喷涂、电泳工艺或流化床技术涂覆上一层绝缘材料。这种类型的涂覆层必须没有针孔并达到耐漏电和抗电弧放电等所规定的厚度要求。在涂覆绝缘层后，采用化学镀铜和电镀铜覆盖在绝缘层上，然后通过蚀刻以提供所要求的表面导体和镀覆孔。对于这种类型来说，金属芯材可以是铜、铝或钢，其功用多数是作为散热层或增强板。

4.2.1 Type Classifications (分类)

Metal Core Printed Board Types (金属芯印制板类型)



图421a

Laminated Type Metal Core Printed Board

层压型金属芯印制板

- Single conductive layer on both sides and insulated from the metal core substrate. Conductive material to be copper foil and electrodeposited copper.
- 两面上各有一层与金属芯基板绝缘的导电层，导电材料是覆铜箔和电镀铜。

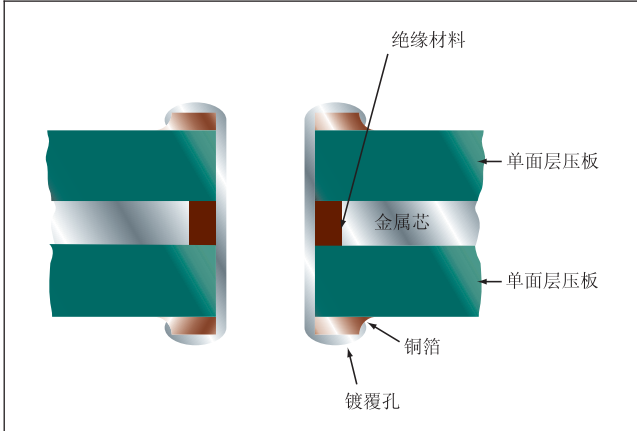

图421b

Laminated Type Metal Core Multilayer Printed Board

层压型金属芯多层印制板

- More than one conductive layer on one or both sides and insulated from the metal core substrate. Conductive material to be copper foil and electrodeposited copper.
- 一面或两面上有一层以上与金属芯基板绝缘的导电层。导电材料是覆铜箔和电镀铜。

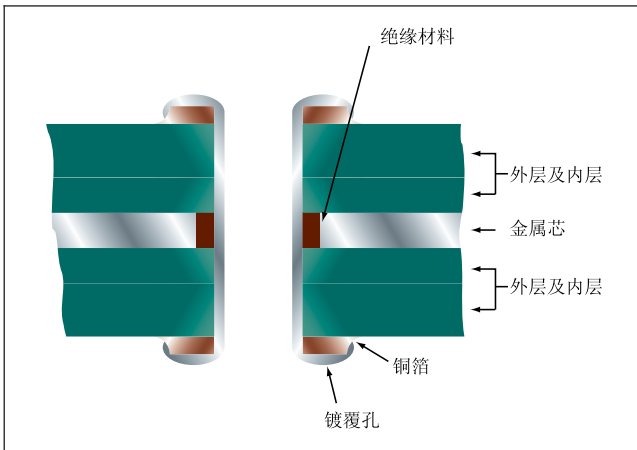

图421c

Insulated-Metal-Substrate Metal Core Printed Board

绝缘的金属基板芯印制板

- Single conductive layer on both sides and insulated from the metal core substrate. Conductive material to be electroless copper and a copper flash is then applied over all surfaces. From this point on, document printed board fabrication processes are employed. This process is generally limited to double-sided printed boards only.
- 两面各有一层导电层，且与金属芯基板绝缘。导电材料是在全部表面进行化学镀铜和闪镀铜。然后再采用常规的印制生产工艺进行制作。这种工艺通常仅限于生产金属芯双面印制板。

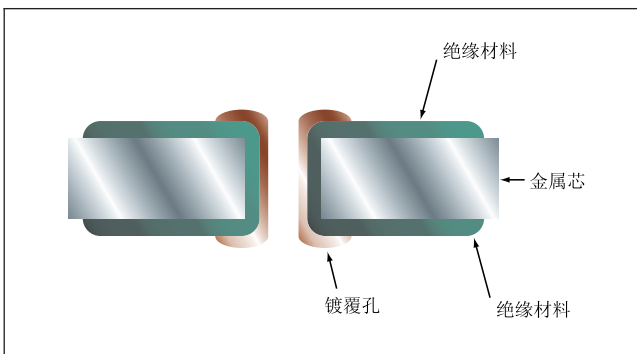

4.2.2 Spacing Laminated Type (层压型板的间距)



图422a

**Target Condition - Class 1,2,3 (目标条件 - 1,2,3级)**

- The spacing between the metal core and adjacent conductive surfaces exceeds 0.1 mm [0.0040 in].
- 金属芯与邻近导电表面之间的间距超过0.1mm[0.0040in]。

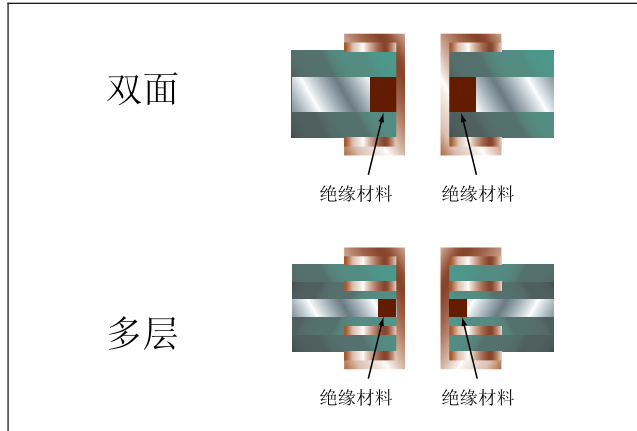

图422b

**Acceptable - Class 1,2,3 (可接受条件 - 1,2,3级)**

- The spacing between the metal core and the PTH or the metal core and adjacent conductive surfaces is greater than 0.1 mm [0.0040 in].
- 金属芯与镀覆孔之间或金属芯与相邻导电表面之间的间距大于0.1mm[0.0040in]。

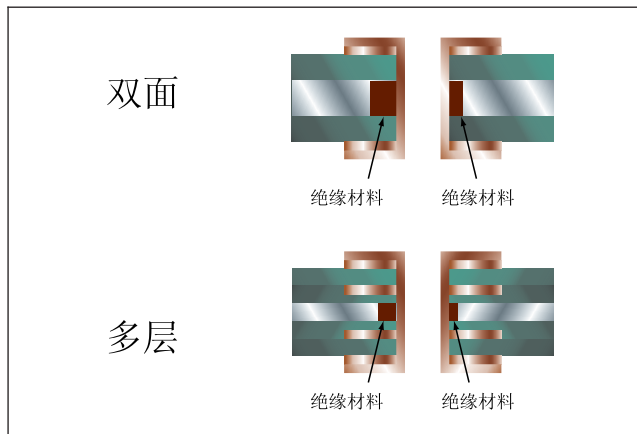

图422c

**Nonconforming - Class 1,2,3 (不符合条件 - 1,2,3级)**

- Defects either do not meet or exceed above criteria.
- 缺陷不符合或超出上述要求。

4.2.3 Insulation Thickness, Insulated Metal Substrate (绝缘型金属基板的绝缘厚度)

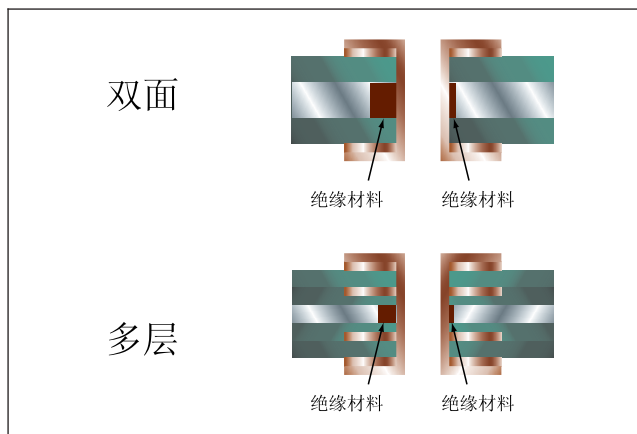

图423a

Target Condition - Class 1,2,3 (目标条件 - 1,2,3级)

- Insulation thickness exceeds requirements of the table below.
- 绝缘厚度超过下表要求。

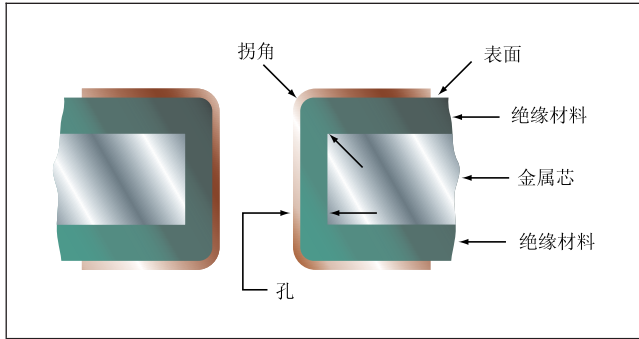

图423b

Acceptable - Class 1,2,3 (可接受条件 - 1,2,3级)

- Insulation thickness meets requirements of the table below.
- 绝缘厚度满足下表要求。

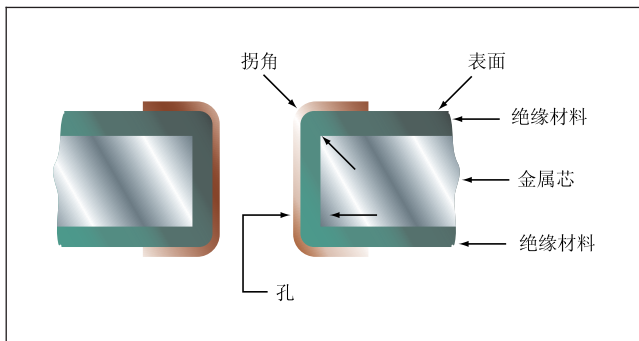

图423c

Nonconforming - Class 1,2,3 (不符合条件 - 1,2,3级)

- Defects either do not meet or exceed above criteria.
- 缺陷不符合或超出上述要求。

Description (说明)	Insulation Process* (绝缘制程*)			
	A	B	C	D
Hole (minimum) (孔 (最小))	0.050 mm [0.0020 in]	0.025 mm [0.000984 in] - 0.065 mm [0.00256 in]	0.125 mm [0.004921 in]	0.125 mm [0.004921 in]
Surface (minimum) (表面 (最小))	0.050 mm [0.0020 in]	0.025 mm [0.000984 in] - 0.065 mm [0.00256 in]	0.125 mm [0.004921 in]	N/A
Knee** (minimum) (拐角** (最小))	0.025 mm [0.000984 in]	0.025 mm [0.000984 in]	0.075 mm [0.00295 in]	N/A

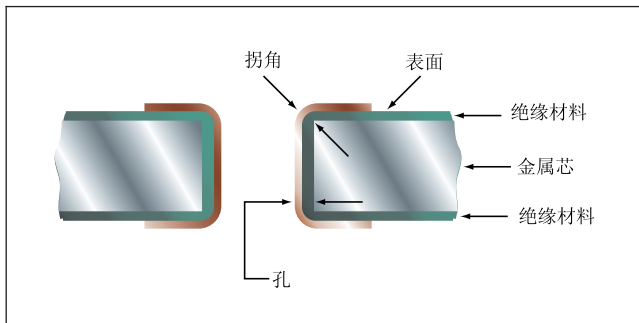
\*Applies to insulated-metal-substrate board only.  
 \*\*Junction where the hole wall and surface meet.  
 Process A - Spray Coating  
 Process B - Electrophoretic Deposition  
 Process C - Fluidized Bed Process  
 Process D - Molding Process

\*仅适用于绝缘金属基材型金属芯印制板  
 \*\*指孔壁和板面相交处  
 制程A - 喷涂制程  
 制程B - 电泳沉积制程  
 制程C - 流化床制程  
 制程D - 模塑制程

4.2.4 Insulation Material Fill, Laminated Type Metal Core (层压型金属芯板的绝缘材料填充)



图424a

**Target Condition - Class 1,2,3 (目标条件 - 1,2,3级)**

- Insulating material fills the entire area between the PTH and the metal core without any voids or areas of missing insulation.
- 镀覆孔与金属芯之间的整个区域填满绝缘材料，没有任何空洞或绝缘材料缺失区域。

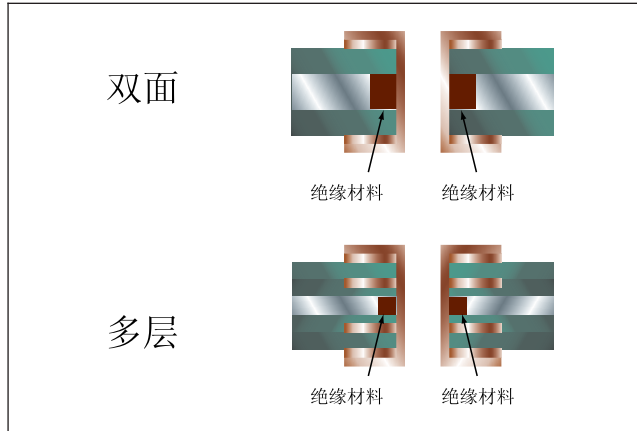

图424b

**Acceptable - Class 1,2,3 (可接受条件 - 1,2,3级)**

- Insulating material meets minimum thickness and dielectric spacing requirements.
- Voids or resin recession does not cause spacing to be less than acceptability requirements.
- 填充的绝缘材料满足最小厚度和介质间距的要求。
- 空洞或树脂凹缩没有造成其介质间距低于可接受性要求。

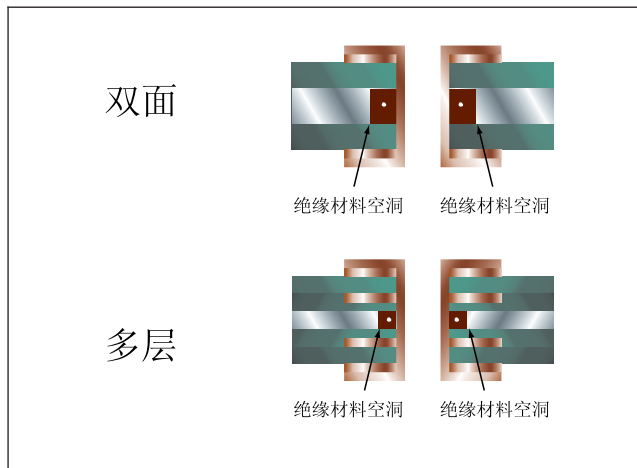

图424c

**Nonconforming - Class 1,2,3 (不符合条件 - 1,2,3级)**

- Defects either do not meet or exceed above criteria.
- 缺陷不符合或超出上述要求。

4.2.5 Cracks in Insulation Material Fill, Laminated Type (层压型板绝缘材料填充中的裂缝)

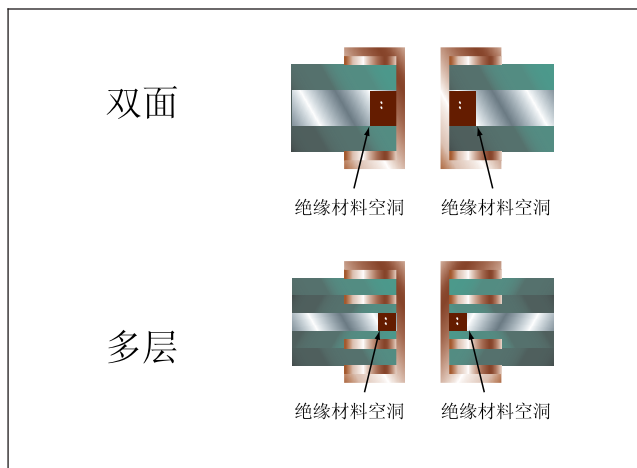

图425a

**Target Condition - Class 1,2,3 (目标条件 - 1,2,3级)**

- There are no cracks in the insulating fill material.
- 绝缘填充材料中没有裂缝。

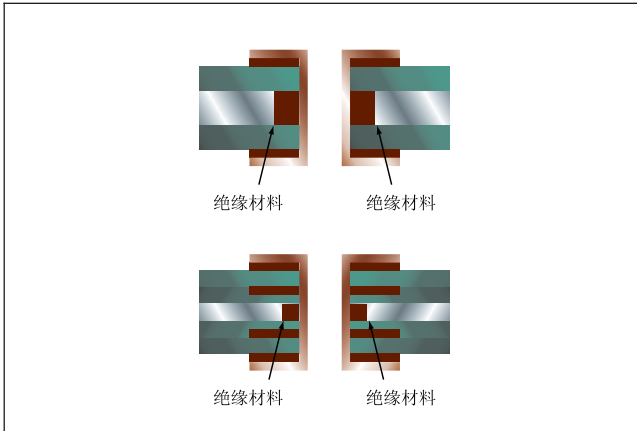

图425b

**Acceptable - Class 1,2,3 (可接受条件 - 1,2,3级)**

- Wicking, radial cracks, lateral spacing or voids in the hole-fill insulation material does not reduce the electrical spacing between adjacent conductive surfaces to less than 100  $\mu\text{m}$  [0.003937 in].
- Wicking and/or radial cracks does not exceed 75  $\mu\text{m}$  [0.00295 in] from the PTH edge into the hole-fill.
- 孔填充绝缘材料中的芯吸、径向裂缝、横向间距或空洞等没有将相邻导电面之间的电气间距减小到低于100 $\mu\text{m}$ [0.003937 in]。
- 从镀覆孔边缘到孔内填充物间的芯吸和（或）径向裂缝不超过75 $\mu\text{m}$ [0.00295in]。

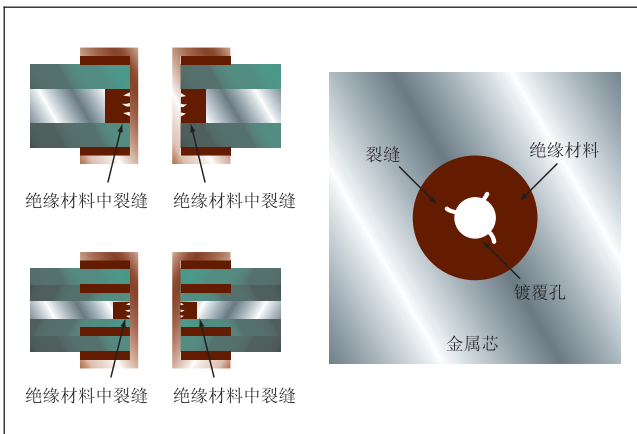

图425c

**Nonconforming - Class 1,2,3 (不符合条件 - 1,2,3级)**

- Defects either do not meet or exceed above criteria.
- 缺陷不符合或超出上述要求。

### 4.2.6 Core Bond to Plated-Through Hole Wall (金属芯与镀覆孔壁的连接)

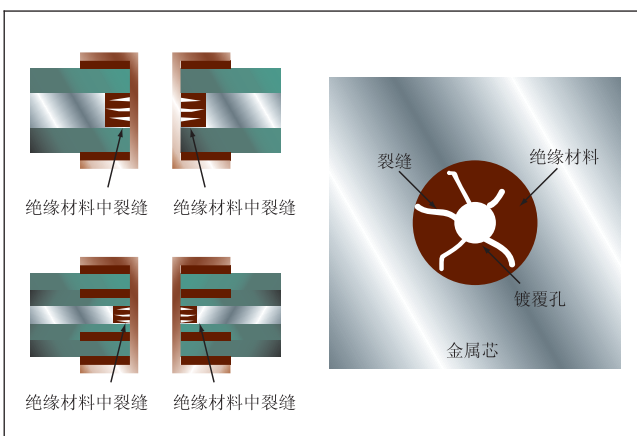

图426a

#### Target Condition - Class 1,2,3 (目标条件 - 1,2,3级)

- Complete bond on both sides.
- 两侧均完全粘接。

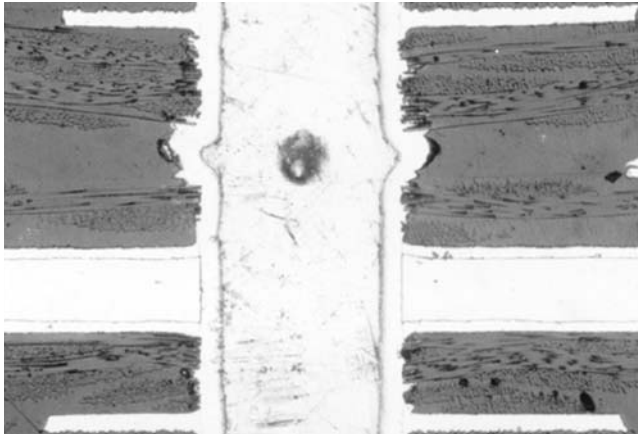

图426b

#### Acceptable - Class 1,2,3 (可接受条件 - 1,2,3级)

- Interconnection separation not more than 50% of the non-copper core thickness. If copper clad core is used it **shall not** have any separation in the copper portion of the interconnect.
- 互连处的分离不大于非铜金属芯厚度的50%。如采用覆铜金属芯，则在互连处的铜部分**不应当**出现任何分离的现象。

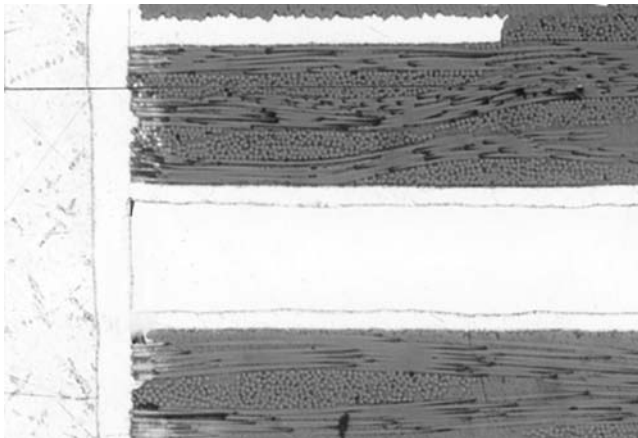

图426c

#### Nonconforming - Class 1,2,3 (不符合条件 - 1,2,3级)

- Defects either do not meet or exceed above criteria.
- 缺陷不符合或超出上述要求。

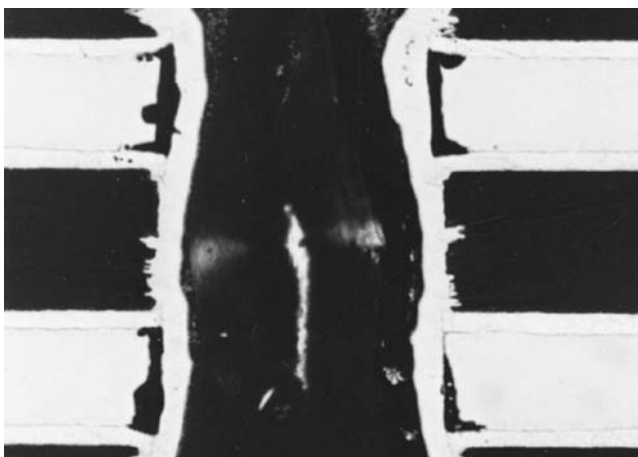

### Introduction (引言)

This section covers acceptability criteria for flush printed boards. In flush printed boards, the surfaces, holes and other parameters for acceptability are the same as in standard single-and double-sided printed boards. This section covers the additional parameters that are important to the evaluation of flush printed boards.

本节涵盖了齐平印制板的可接受性准则。在齐平印制板中，板表面、孔和其它性能的可接受性与常规的单面及双面印制板相同。而本节所涉及的是对齐平印制板的评定有重要作用的附加参数。

#### 4.3.1 Flushness of Surface Conductor (表面导体的平整性)

The application of flush circuitry requires that the conductor surfaces and the base material be essentially in the same plane.

齐平电路要求导体表面和基材表面必需处在同一平面上。



图431a

##### Target Condition - Class 1,2,3 (目标条件 - 1,2,3级)

- Conductor is flush to the base material or surrounding insulating material surface.
- 导体与基材或所围绕的绝缘材料表面齐平。

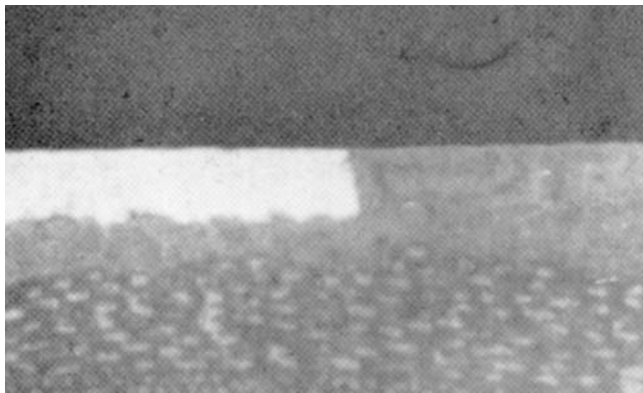

图431b

##### Acceptable - Class 1,2,3 (可接受条件 - 1,2,3级)

- Conductor is not flush but meets the minimum requirements.
- 导体虽不齐平，但满足最低要求。

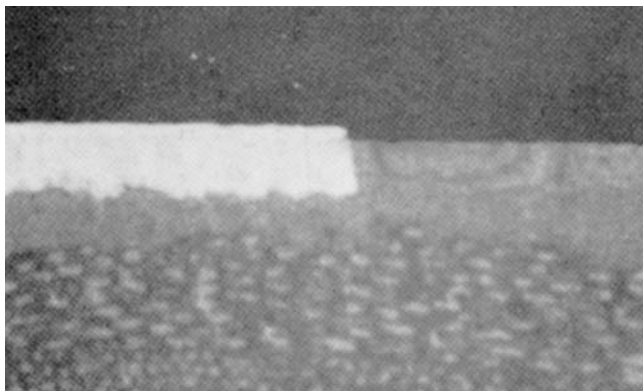

图431c

##### Nonconforming - Class 1,2,3 (不符合条件 - 1,2,3级)

- Defects either do not meet or exceed above criteria.
- 缺陷不符合或超出上述要求。

## Introduction (引言)

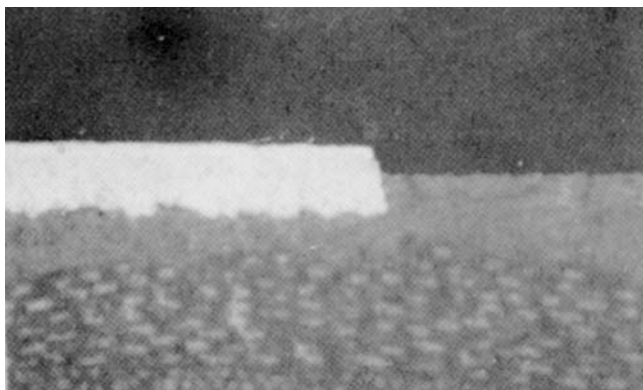
The purpose of this section is to assist the reader in better understanding the importance of correct handling procedures in order to avoid damage and contamination during cleanliness testing.

The following general rules minimize surface contaminants when handling printed boards:

1. Work stations should be kept clean and neat.
2. There should be no eating, drinking or use of tobacco products at the work station or other activities that are likely to cause contamination of the printed board surfaces.
3. Hand creams and lotions containing silicone should not be used since they could result in solderability and other processing problems. Specially formulated lotions are available.
4. Handling of printed boards by their edges is desirable.
5. Lint free cotton or disposable plastic gloves should be used when handling bare printed boards. Gloves should be changed frequently as dirty gloves can cause contamination problems.
6. Unless special racks are provided, stacking printed boards without interleaving protection should be avoided. Cleanliness testing is used to determine organic or inorganic, and ionizable or nonionizable contaminants.

The following are examples of the more common contaminants found on printed boards:

1. Flux residues
2. Particulate matter
3. Chemical salt residues
4. Fingerprints
5. Corrosion (oxides)
6. White residues

Due to the destructive nature of contaminants, it is recommended that cleanliness requirements of applicable procurement documentation be adhered to.

The solvent resistivity **shall** be in accordance with IPC-6010 series unless otherwise specified. The specimens **shall** be tested for ionic contamination in accordance with IPC-TM-650, Method 2.3.25 and 2.3.26.

本节的目的是帮助读者更好地理解正确持取方法的重要性，以避免在清洁度测试过程中导致损坏和污染。当持取印制板时，下列通用规则可使表面污染最小化：

1. 工作台应该保持清洁与整洁。
2. 工作区不应该吃东西、喝饮料或吸烟，不应该作其它可能导致印制板面污染的活动。
3. 不应该使用含硅酮的护手霜和洗手液，因为它们会给印制板的可焊性和其它制程带来问题。可以采用特殊配方的洗手液。
4. 持取印制板时要求夹持板边。
5. 当持取裸板时，应该采用无尘棉织手套或一次性塑料手套。手套应该经常更换，因为脏的手套会导致污染问题。
6. 除非提供专门的架子，否则应该避免板子不加间隔保护而叠放。

下面是在印制板上常见污染的例子：

1. 助焊剂残留物
2. 颗粒物
3. 化学盐类残留物
4. 手指印
5. 腐蚀（氧化物）
6. 白色残留物

由于污染物具有破坏性，建议遵守适用采购文件的清洁度要求。

除非另有规定，清洗溶剂的电阻率应当符合IPC-6010系列文件的要求。应当按照IPC-TM-650测试方法2.3.25和2.3.26测试样本的离子污染。

## Introduction (引言)

This section describes the methods and requirements for solderability testing. Solderability of printed boards verifies the state of the printed board expected during assembly. Solderability testing is performed on both the surface and PTHs. IPC-J-STD-003 describes in detail the different solderability tests as shown in Table 5-1:

本节介绍了可焊性测试的方法和要求。印制板的可焊性测试是为了验证印制板在组装时的可焊性。在板的两面和镀覆孔内实施可焊性测试。IPC-J-STD-003详细地介绍了各种不同的可焊性测试，表5-1列出了各种可焊性测试方法。

Table 5-1 Test Method Selection within IPC-J-STD-003 (表5-1 IPC-J-STD-003中的测试方法选择)

Test Method (测试方法)	Applies to Surface Features (适用于表面特征)	PTHs (镀覆孔)
<b>Tests with Visual Assessment Criteria (具有外观评定标准的测试)</b>		
A – Edge Dip Test / A1 – Edge Dip Test A – 边缘浸焊测试 / A1 – 边缘浸焊测试	X	N/A 不适用
B – Rotary Dip Test / B1 – Rotary Dip Test B – 摆动浸焊测试 / B1 – 摆动浸焊测试	X (Solder Source Side Only) X (仅在焊接终止面)	X
C – Solder Float Test / C1 – Solder Float Test C – 浮焊测试 / C1 – 浮焊测试	X (Solder Source Side Only) X (仅在焊接终止面)	X
D – Wave Solder Test / D1 – Wave Solder Test D – 波峰焊测试 / D1 – 波峰焊测试	X (Solder Source Side Only) X (仅在焊接终止面)	X
E – Surface Mount Simulation Test / E1 – Surface Mount Simulation Test E – 表面贴装模拟测试 / E1 – 表面贴装模拟测试	X	N/A 不适用
<b>Tests with Force Measurement Criteria (具有力度测量标准的测试)</b>		
F – Wetting Balance Test / F1 – Wetting Balance Test F – 润湿平衡测试 / F1 – 润湿平衡测试	X	X

Along with the solderability method, the user **shall** specify as part of the purchase order agreement, the required coating durability. The following are guidelines for determining the needed level of coating durability, not product performance classes. Durability conditioning and solderability testing **shall** be performed per IPC-J-STD-003.

Coating Durability categories:

**Category 1 – Minimum Coating Durability;** intended for printed boards which will be soldered within 30 days from the time of manufacture and are likely to experience minimum thermal exposures.

**Category 2 – Average Coating Durability;** intended for printed boards likely to experience storage up to six months from the time of manufacture and moderate thermal or solder exposures.

**Category 3 – Maximum Coating Durability;** intended for printed boards likely to experience long storage (over six months) from the time of manufacture, and may experience severe thermal or solder processing steps, etc. It should be recognized that there may be a cost premium or delivery delay associated with printed boards ordered to this durability level.

The test specimen **shall** be a representative coupon, a portion of the printed board being tested, or a whole board if within size limits, such that an immersion depth defined in the individual method is possible. Sample holes should be selected at random.

除了可焊性测试方法以外，用户还应当在采购协议中规定所要求的涂覆层耐久性。下面是确定所需涂覆层耐久性类型的指南，但它不是产品性能等级。应当按IPC/J-STD-003的规定完成加速老化和可焊性测试。

涂覆层耐久性分类：

**1类** – 最低水平的涂覆层耐久性。指制造完工后30天内要焊接的印制板，可能会暴露于最低程度的热环境中。

**2类** – 一般水平的涂覆层耐久性。指制造完工后经过6个月以内贮存的印制板，可能会暴露于中等程度的热或焊接环境中。

**3类** – 最高水平的涂覆层耐久性。指制造完工后经过长时间（6个月以上）贮存的印制板，可能会经历严苛的热环境或焊接工序等。但应该注意到，采购该类印制板会增加额外成本、延长交货期。

测试样品应当为具有代表性的测试附连板、被测试印制板的一部分，或如果尺寸在限定范围内、以至可以达到测试方法规定的浸焊深度，也可用整块印制板。试样的样品孔应该随机抽取。

5.1.1 Plated-Through Holes (Applicable to Test C/C1) (镀覆孔 (适用于C/C1测试))



图511a



图511b

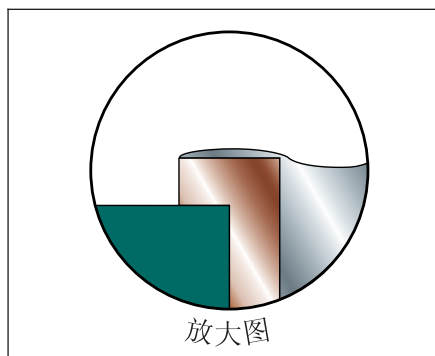

图511d

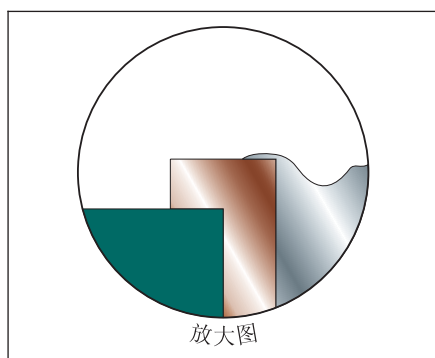

图511c



图511e

**Target Condition - Class 1,2,3**  
(目标条件 - 1,2,3级)

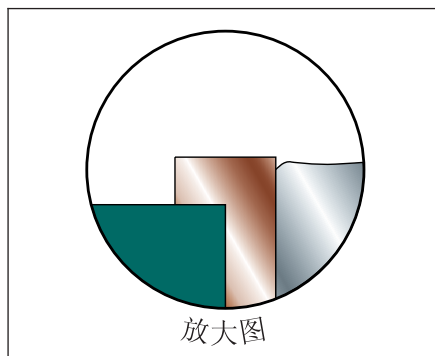
- Solder has risen in all plated holes.
- There is no nonwetted or exposed base metal.
- 所有镀覆孔中的焊料已完全攀升。
- 没有不湿润或基底金属基材露出。

**Acceptable - Class 3**  
(可接受条件 - 3级)

- Solder has risen in all plated holes.
- Solder fully wets the walls of the hole. There is no evidence of nonwetting or exposed base metal on any PTH.
- 所有金属通孔中的焊料已完全攀升。
- 焊料完全润湿了孔壁。任何镀覆孔内没有不润湿或暴露金属基材的迹象。

**Acceptable - Class 1,2**  
(可接受条件 - 1,2级)

- Solder fully wets the wall area of the PTH holes.
- Solder shall plug 1.5 mm [0.0591 in] diameter (complete filling is not necessary).
- 焊料已完全润湿了镀覆孔的孔壁。
- 焊料应当堵塞孔径小于1.5mm[0.0591 in]的孔 (没有必要完全填满)。

**Nonconforming - Class 1,2,3**  
(不符合条件 - 1,2,3级)

- Defects either do not meet or exceed above criteria.
- 缺陷不符合或超出上述要求。

## Introduction (引言)

Testing of printed boards **shall** be in accordance with IPC-9252 unless otherwise AABUS.

除非另由供需双方协商确定，否则印制板的电气测试应当按照IPC-9252进行。





定义提交/审批表

此表是为了及时收录行业中广泛使用的术语和定义，以修订本标准。欢迎个人或单位参与发表意见。请填写此表并反馈给：

IPC  
3000 Lakeside Drive, Suite 309S  
Bannockburn, IL 60015-1249  
传真: 847 615.7105

申请人信息：

姓名: \_\_\_\_\_  
公司名称: \_\_\_\_\_  
所在城市: \_\_\_\_\_  
所属国家: \_\_\_\_\_  
电话号码: \_\_\_\_\_  
日期: \_\_\_\_\_

- 新的术语及定义的申报.
- 对原有术语及定义的补充.
- 对原有术语及定义的修改.

术语	定义

如空间不足,请写在背面或附页上.

插图:  不适用  要求  待提供

包括: 电子文件名称: \_\_\_\_\_

适用此术语及定义的文件: \_\_\_\_\_  
\_\_\_\_\_  
\_\_\_\_\_

与此术语及定义相关的委员会: \_\_\_\_\_  
\_\_\_\_\_  
\_\_\_\_\_

<b>由IPC 内部填写</b>	
<b>IPC Office</b>	<b>Committee 2-30</b>
Date Received: _____	Date of Initial Review: _____
Comments Collated: _____	Comment Resolution: _____
Returned for Action: _____	Committee Action: _____
Revision Inclusion: _____	<input type="checkbox"/> Accepted <input type="checkbox"/> Rejected <input type="checkbox"/> Accept Modify
<b>IEC Classification</b>	
Classification Code • Serial Number	
Terms and Definition Committee Final Approval Authorization: Committee 2-30 has approved the above term for release in the next revision.	
Name: _____ Committee: <u>IPC 2-30</u> Date: _____	

此页留作空白



# 标准改善填写表

# IPC-A-600H CN

此表的目的在于让这标准的有关工业使用者向IPC技术委员会提供建议.

欢迎个人或集体对IPC提交建议.我们将会收集所有的建议并上交给相应的委员会.

如果您能提供改善建议, 请填好下表并递至:

IPC  
3000 Lakeside Drive, Suite 309S  
Bannockburn, IL 60015-1249  
传真: 847 615.7105  
电子邮件: answers@ipc.org

1. 我想对以下提出更改建议:

要求, 章节数  
 那种测试方法 \_\_\_\_\_, 章节数 \_\_\_\_\_

以上章节数被证明为:

不清楚       不适用       有误的  
 其他

2. 具体的更改建议:

3. 对于标准的其他改进建议:

提交人:

姓名

电话

公司

电子邮件

地址

城市/国家/洲

日期

此页留作空白



## 会员申请表

衷心感谢您成为IPC协会会员和对IPC的支持！IPC会员资格是针对企业整体的，成为IPC会员意味着本申请表中所填公司全体员工都可享受会员裨益。

为了使IPC能更快更好地为会员服务，请在以下项目中选择最能反映单位情况的一栏，并按提示填写。

### 印制电路板制造商

生产和销售印制电路板（PCB）或其它电子互连产品，并将产品销售给其它公司。贵公司生产和销售哪些产品？

单面和双面刚性多层印制板       挠性印制板       其它互连产品

董事长/总经理： \_\_\_\_\_

### 电子制造服务（EMS）公司

根据合同生产印制电路组件，并可提供其它电子互连产品进行销售。

董事长/总经理： \_\_\_\_\_

### OEM-原始设备制造商

采购、使用和/或自制的印制电路板或其它电子互连产品以制造、销售终端产品。

系列产品： \_\_\_\_\_

### 行业供应商

提供制造或组装电子互连产品所用的原材料、机器、设备或技术服务。

服务于哪个行业？       PCB       EMS       二者均有

供应产品品种： \_\_\_\_\_

### 政府机构/科研院校

设计、研究、使用电子互连产品的非盈利事业单位。

### 咨询公司

提供何种服务： \_\_\_\_\_





## 会员申请表

### 单位情况:

单位名称: \_\_\_\_\_

地址: \_\_\_\_\_

电话: \_\_\_\_\_ 传真: \_\_\_\_\_

联系人: \_\_\_\_\_ 职务: \_\_\_\_\_

电子邮件: \_\_\_\_\_ 网址: \_\_\_\_\_

### 会费详情:

#### 会费

IPC收到贵公司申请表并且会费付讫之日起, 贵公司开始享受所有IPC会员裨益, 会员期持续一年或者两年取决于贵公司在以下不同付费情况中的选择。会费收取仅限于**人民币**。

请选择一项:

<b>原始会员:</b> <input type="checkbox"/> 一年会员期USD 1000 <input type="checkbox"/> 两年会员期USD 1800 (节省10%)	<b>政府机构、科研机构等非盈利组织</b> <input type="checkbox"/> 一年会员期USD 250 <input type="checkbox"/> 两年会员期USD 450 (节省10%)
<b>附加会员: (同一集团内有另一家单位是IPC会员)</b> <input type="checkbox"/> 一年会员期USD 800 <input type="checkbox"/> 两年会员期USD 1440 (节省10%)	<b>咨询公司 (员工数少于6人)</b> <input type="checkbox"/> 一年会员期USD 600 <input type="checkbox"/> 两年会员期USD 1080 (节省10%)
<b>年销售额不超过500万美元的企业</b> <input type="checkbox"/> 一年会员期USD 600 <input type="checkbox"/> 两年会员期USD 1080 (节省10%)	

请妥善填写好本表格传真或电子邮件至:

会员部负责人

IPC-爱比西技术咨询(上海)有限公司

Tel: 86-21-54973435\*605

Fax: 86-21-54973437

IPCMembership@ipc.org

www.ipc.org\china.ipc.org



# GET AHEAD ...

## with IPC Training & Certification Programs

**Smart decisions and top-notch quality are critical to success — particularly in the highly competitive, ever-changing electronic interconnection industry. Training alone may help with your quality initiatives, but when key employees actually have an industry-recognized certification on industry standards, you can leverage that additional credibility as you pursue new customers and contracts.**

Through its international network of licensed and audited training centers, IPC — Association Connecting Electronics Industries® offers globally recognized, industry-traceable training and certification programs on key industry standards. Developed by users, academics and professional trainers, IPC programs reflect a standardized industry consensus. In addition, the programs are current: Periodic recertification is required, and course materials are updated for each document revision with support from the same industry experts who contributed to the standard.

### Why Pursue Certification?

Investing in IPC training and certification programs can help you:

- Demonstrate to current and potential customers that your company considers rigorous quality control practices very important.
- Meet the requirements of OEMs and electronics manufacturing companies that expect their suppliers to have these important credentials.
- Gain valuable industry recognition for your company and yourself.
- Facilitate quality assurance initiatives that have become important in international trading.

### Choose From Two Levels of Certification

Two types of certification are available, each of which is a portable credential granted to the individual in the same manner as a degree from a college or trade school.

**Certified IPC Trainer (CIT)** — Available exclusively through IPC authorized training centers, CIT certification is recommended for individuals in companies, independent consultants and faculty members of education and training institutions. Upon successful completion of this train-the-trainer program, candidates are eligible to deliver CIS training. They also receive materials for conducting application-level (CIS) training.

**Certified IPC Application Specialist (CIS)** — CIS training and certification is recommended for any individual who uses a standard, including operators, inspectors, buyers and management.

### Earn Credentials on Five Key IPC Standards

Programs focused on understanding and applying criteria, reinforcing discrimination skills and supporting visual acceptance criteria in key standards include:

- IPC-A-610, *Acceptability of Electronic Assemblies*
- IPC-A-600, *Acceptability of Printed Boards*
- IPC/WHMA-A-620, *Requirements and Acceptance for Cable and Wire Harness Assemblies*

Programs covering standards knowledge plus development of hands-on skills include:

- J-STD-001, *Requirements for Soldered Electrical and Electronic Assemblies*
- IPC-7711/IPC-7721, *Rework of Electronic Assemblies/Repair and Modification of Printed Boards and Electronic Assemblies*

### Get Started by Contacting Us Today

More than 250,000 individuals at thousands of companies worldwide have earned IPC certification. Now it's your turn! For more information, including detailed course information, schedules and course fees, please visit [www.ipc.org/certification](http://www.ipc.org/certification) to find the closest authorized training center.



Photo courtesy of  
Electronics Yorkshire

*Association Connecting Electronics Industries*



3000 Lakeside Drive, Suite 309 S  
Bannockburn, IL 60015

847-615-7100 **tel**  
847-615-7105 **fax**  
[www.ipc.org](http://www.ipc.org)  
ISBN #1-580986-77-3

上海办公室  
上海市谈家渡路28号盛泉大厦16AB  
电话: (86 21) 54973435  
传真: (86 21) 54973437  
网址: [china.ipc.org](http://china.ipc.org)

深圳办公室  
深圳市南山区高新科技园南区方大大厦1807室  
电话: (86 755) 86141218/19  
传真: (86 755) 86141226

标准分享网 [www.bzfxw.com](http://www.bzfxw.com) 免费下载

北京办公室  
北京市经济技术开发区宏达北路18号  
大地国际大厦407A  
电话: (86 10) 67885326  
传真: (86 10) 67885326